

# Quick Installation Guide

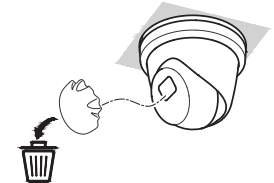
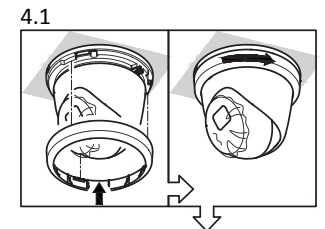
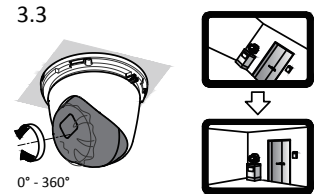
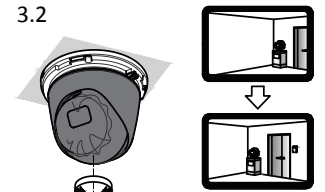
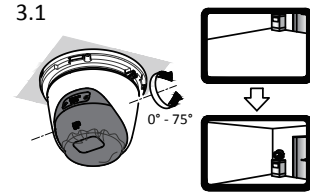
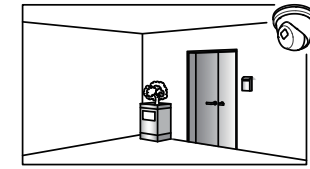
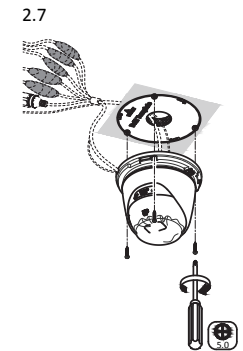
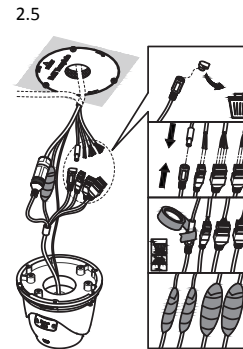
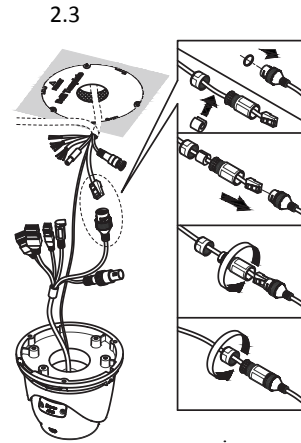
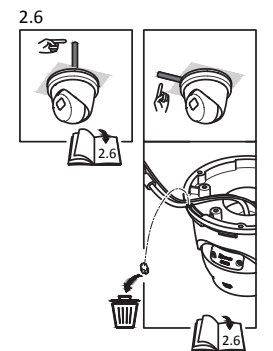
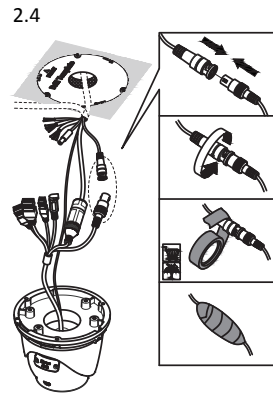
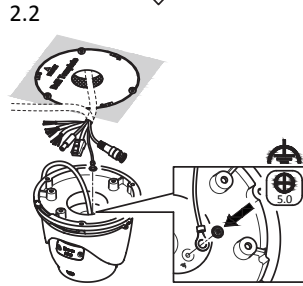
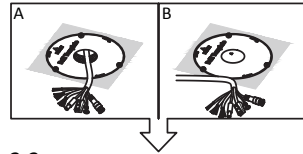
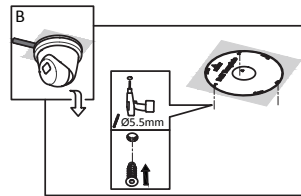
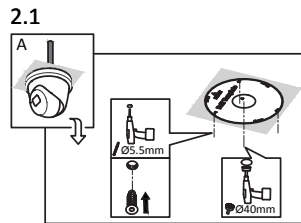
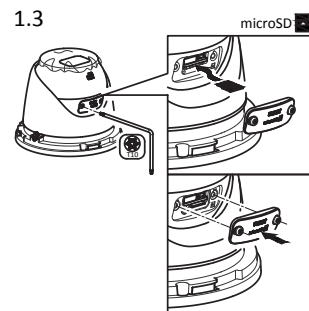
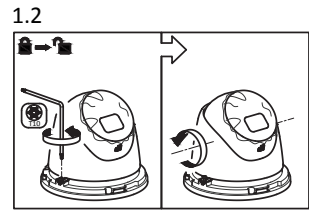
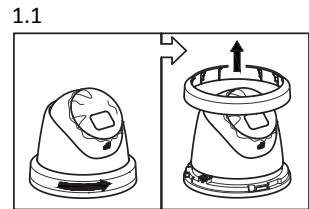
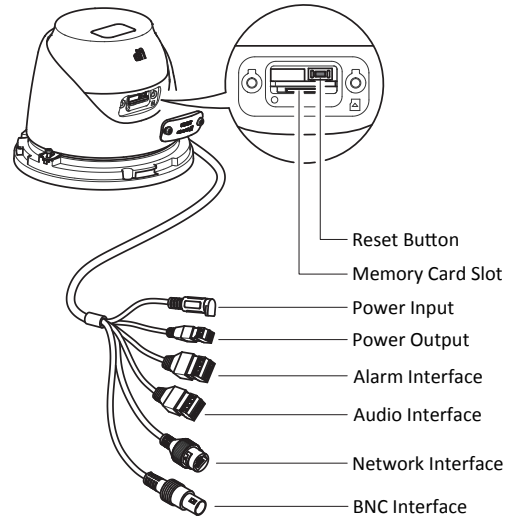

## Reset and Restore Camera

Press **Reset** button for about 10s when the camera is powering on or rebooting to restore the default settings, including the user name, password, IP address, port No., etc.

For the position of the reset button, refer to the figure in the interface introduction page.