

**Quick Operation Guide of
0700/8800/8700 Series NVR**

TABLE OF CONTENTS

NVR Pre-Installation	2
NVR Installation	2
Hard Disk Installation	2
Front Panel	5
Rear Panel	12
Peripheral Connections	15
Wiring of Alarm Input / Output.....	15
Using of Alarm Connectors.....	15
Controller Connection.....	16
Specifications	17
HDD Storage Calculation Chart	24
Menu Operation	25
Menu Structure.....	25
Startup and Shutdown	26
Using the Start Wizard	26
Live View.....	31
Adding and Configuring IP Cameras	31
Adding IP Cameras	31
Configuring Basic Parameters of IP Cameras	32
PTZ Control	33
PTZ Settings.....	34
PTZ Control	34
Playback.....	35
Instant playback by channel	35
Playback by channel.....	35
Backup	36
Accessing by Web Browser	38
Logging In.....	38
Live View.....	38
Recording.....	39
Playback.....	40
Log	41

Thank you for purchasing our product. If there is any question or request, please do not hesitate to contact dealer. This manual is applicable to **8700, 8800 and 0700 series NVR**.

NVR Pre-Installation

The 0700/8800/8700 series NVR are highly advanced surveillance equipment that should be installed with care. Please take into consideration the following precautionary steps before installation of the NVR.

1. Keep all liquids away from the NVR.
2. Install the NVR in a well-ventilated and dust-free area.
3. Ensure environmental conditions meet factory specifications.
4. Install a manufacturer recommended HDD.

NVR Installation

During the installation of the NVR:

1. Use brackets for rack mounting.
2. Ensure there is ample room for audio and video cables.
3. When routing cables, ensure that the bend radius of the cables are no less than five times than its diameter.
4. Connect both the alarm and RS-485 cable.
5. Allow at least 2cm (~0.75-inch) of space between racks mounted devices.
6. Ensure the NVR is grounded.
7. Environmental temperature should be within the range of -10 °C ~ 55 °C, 14 °F ~ 131 °F.
8. Environmental humidity should be within the range of 10% ~ 90%.

Hard Disk Installation

Before you start:

Disconnect the power from the NVR before installing a hard disk drive (HDD). A factory recommended HDD should be used for this installation.

Up to 8 SATA hard disks can be installed on your NVR.

Tools Required: Screwdriver.

Steps (for 0700):

1. Fasten the hard disk mounting handle to the hard disk with screws.



2. Insert the key and turn in clockwise direction to open the panel lock.



3. Press the buttons on the panel of two sides and open the front panel.

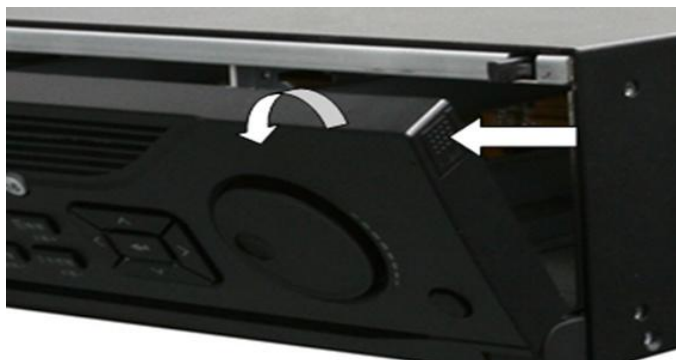

4. Insert the hard disk along the slot until it is placed into position.

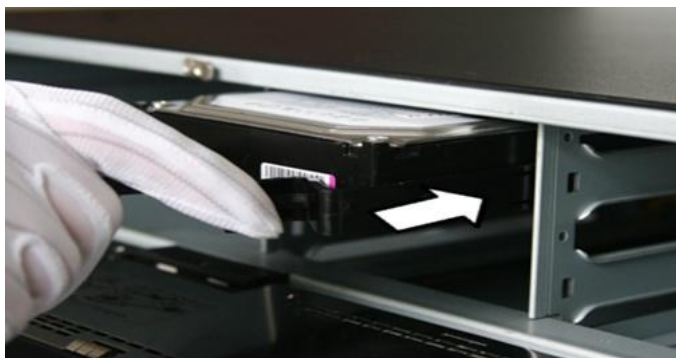

5. Repeat the above steps to install other hard disks onto the NVR. After having finished the installation of all hard disks, close the front panel and lock it with the key again.



Steps (for 8700 and 8800):

1. Remove the cover from the NVR by unfastening the screws on the rear and side panel.



2. Connect one end of the data cable to the motherboard of NVR and the other end to the HDD.

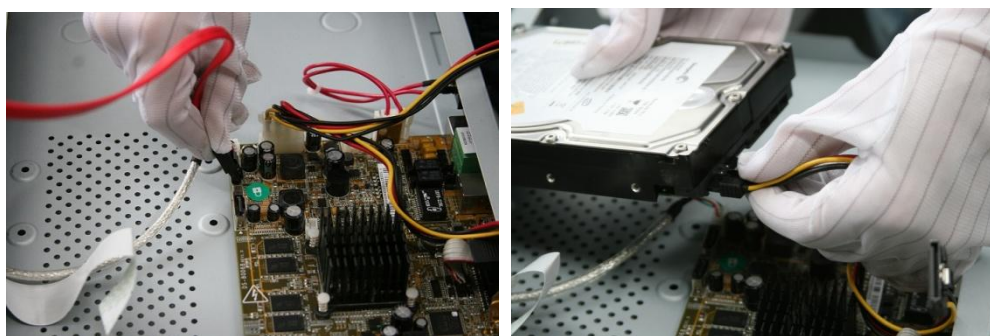

3. Connect the power cable to the HDD.



4. Place the HDD on the bottom of the device and then fasten the screws on the bottom to fix the HDD.



Front Panel

0700 Series



No.	Name	Function Description	
1	Status Indicators	ALARM	Turns red when a sensor alarm is detected.
		READY	Ready LED is normally blue, indicating that the device is functioning properly.
		STATUS	Turns blue when device is controlled by an IR remote.
			Turns red when controlled by a keyboard and purple when IR remote and keyboard is used at the same time.
		HDD	Flashes red when data is being read from or written to HDD.
		MODEM	Reserved for future usage.
		TX/RX	Flashes blue when network connection is functioning properly.
GUARD	Guard LED turns blue when the device is in armed status; at this time, an alarm is enabled when an event is detected.		
	The LED turns off when the device is unarmed. The arm/disarm status can be changed by pressing and holding on the ESC button for more than 3 seconds in live view mode.		
2	IR Receiver	Receiver for IR remote	
3	DVD-R/W	Slot for DVD-R/W.	
4	Alphanumeric Buttons	Switch to the corresponding channel in Live view or PTZ Control mode.	
		Input numbers and characters in Edit mode.	
		Switch between different channels in Playback mode.	
		The light of the button is blue when the corresponding channel is recording; it is red when the channel is in network transmission status; it is pink when the channel is recording and transmitting.	
5	USB Interfaces	Universal Serial Bus (USB) ports for additional devices such as USB mouse and USB Hard Disk Drive (HDD).	
6	Composite Keys	ESC	Back to the previous menu.
			Press for Arming/disarming the device in Live View mode.
		REC/SHOT	Enter the Manual Record setting menu.
			In PTZ control settings, press the button and then you can call a PTZ preset by pressing Numeric button.

No.	Name	Function Description	
		It is also used to turn audio on/off in the Playback mode.	
		PLAY/AUTO	
		The button is used to enter the Playback mode.	
		It is also used to auto scan in the PTZ Control menu.	
		ZOOM+	
		Zoom in the PTZ camera in the PTZ Control setting.	
		A/FOCUS+	
		Adjust focus in the PTZ Control menu.	
		It is also used to switch between input methods (upper and lowercase alphabet, symbols and numeric input).	
		EDIT/IRIS+	Edit text fields. When editing text fields, it will also function as a Backspace button to delete the character in front of the cursor.
			On checkbox fields, pressing the button will <i>tick</i> the checkbox.
			In PTZ Control mode, the button adjusts the iris of the camera.
			In Playback mode, it can be used to generate video clips for backup.
			Enter/exit the folder of USB device and eSATA HDD.
		MAIN/SPOT/ZOO	Switch between main and spot output.
		M-	In PTZ Control mode, it can be used to zoom out the image.
		F1/ LIGHT	Select all items on the list when used in a list field.
			In PTZ Control mode, it will turn on/off PTZ light (if applicable).
			In Playback mode, it is used to switch between play and reverse play.
		F2/ AUX	Cycle through tab pages.
			In synchronous playback mode, it is used to switch between channels.
MENU/WIPER	Press the button will help you return to the Main menu (after successful login).		
	Press and hold the button for 5 seconds will turn off audible key beep.		
	In PTZ Control mode, the MENU/WIPER button will start wiper (if applicable).		
	In Playback mode, it is used to show/hide the control interface.		
PREV/FOCUS-	Switch between single screen and multi-screen mode.		
	In PTZ Control mode, it is used to adjust the focus in conjunction with the A/FOCUS+ button.		
PTZ/IRIS-	Enter the PTZ Control mode.		
	In the PTZ Control mode, it is used to adjust the iris of the PTZ camera.		
7	Control Buttons	DIRECTION	
		The DIRECTION buttons are used to navigate between different fields and items in menus.	
		In the Playback mode, the Up and Down button is used to speed up and slow down recorded video. The Left and Right button will select the next and previous record files.	
		In Live View mode, these buttons can be used to cycle through channels.	

No.	Name		Function Description
			In PTZ control mode, it can control the movement of the PTZ camera.
		ENTER	The ENTER button is used to confirm selection in any of the menu modes.
			It can also be used to <i>tick</i> checkbox fields.
			In Playback mode, it can be used to play or pause the video.
			In single-frame Playback mode, pressing the button will advance the video by a single frame.
			In Auto-switch mode, it can be used to stop /start auto switch.
8	JOG SHUTTLE Control		Move the active selection in a menu. It will move the selection up and down.
			In Live View mode, it can be used to cycle through different channels.
			In the Playback mode: For 0700-R series, the ring is used to jump 30s forward/backward in video files.
			In PTZ control mode, it can control the movement of the PTZ camera.
9	POWER ON/OFF		Power on/off switch.

8800 Series



No.	Name	Function Description	
1	Status Indicators	POWER	Turns green when NVR is powered up.
		READY	The LED is green when the device is running normally.
		STATUS	The light is green when the IR remote control is enabled; The light is red when the function of the composite keys (SHIFT) are used; The light is out when none of the above condition is met.
		ALARM	The light is red when there is an alarm occurring.
		HDD	Blinks red when HDD is reading/writing.
		Tx/Rx	Blinks green when network connection is functioning normally.
2	DVD-R/W	Slot for DVD-R/W.	
3	Control Buttons	DIRECTION	In menu mode, the direction buttons are used to navigate between different fields and items and select setting parameters.
			In playback mode, the Up and Down buttons are used to speed up and slow down record playing, and the Left and Right buttons are used to move the recording 30s forwards or backwards.
			In the image setting interface, the up and down button can adjust the level bar of the image parameters.
			In live view mode, these buttons can be used to switch channels.
		ENTER	The Enter button is used to confirm selection in menu mode; or used to check checkbox fields and ON/OFF switch.
	In playback mode, it can be used to play or pause the video.		
	In single-frame play mode, pressing the Enter button will play the video by a single frame.		
	In auto sequence view mode, the buttons can be used to pause or resume auto sequence.		
4	Composite Keys	SHIFT	Switch between the numeric or letter input and functions of the composite keys. (Input letter or numbers when the light is out; Realize functions when the light is red.)
		1/MENU	Enter numeral "1";
			Access the main menu interface.
		2/ABC/F1	Enter numeral "2";
Enter letters "ABC";			

No.	Name	Function Description	
		The F1 button when used in a list field will select all items in the list.	
		In PTZ Control mode, it will turn on/off PTZ light and when the image is zoomed in, the key is used to zoom out.	
		3/DEF/F2	Enter numeral "3";
			Enter letters "DEF";
			The F2 button is used to change the tab pages.
			In PTZ control mode, it zooms in the image.
		4/GHI/ESC	Enter numeral "4";
			Enter letters "GHI";
			Exit and back to the previous menu.
		5/JKL/EDIT	Enter numeral "5";
			Enter letters "JKL";
			Delete characters before cursor;
			Check the checkbox and select the ON/OFF switch;
			Start/stop record clipping in playback.
		6/MNO/PLAY	Enter numeral "6";
			Enter letters "MNO";
			Playback, for direct access to playback interface.
		7/PQRS/REC	Enter numeral "7";
			Enter letters "PQRS";
			Open the manual record interface.
		8/TUV/PTZ	Enter numeral "8";
			Enter letters "TUV";
			Access PTZ control interface.
		9/WXYZ/PRE V	Enter numeral "9";
Enter letters "WXYZ";			
Multi-channel display in live view.			
0/A	Enter numeral "0";		
	Shift the input methods in the editing text field. (Upper and lowercase, alphabet, symbols or numeric input).		
	Double press the button to switch the main and auxiliary output.		
5	JOG SHUTTLE Control	Move the active selection in a menu. It will move the selection up and down.	
		In Live View mode, it can be used to cycle through different channels.	
		In the Playback mode, it can be used to jump 30s forward/backward in video files.	
		In PTZ control mode, it can control the movement of the PTZ camera.	
6	POWER ON/OFF	Power on/off switch.	
7	USB Interfaces	Universal Serial Bus (USB) ports for additional devices such as USB mouse and USB Hard Disk Drive (HDD).	
8	IR Receiver	IR receiver interface	

8716:



No.	Name	Function Description
1	Status Indicators	POWER: the POWER LED turns green when NVR is powered up.
		READY: The LED is green when the device is running normally.
		STATUS: 1.The light is green when the IR remote control is enabled; 2.The light is red when the function of the composite keys (SHIFT) are used; 3. The light is out when none of the above condition is met/
		ALARM: the light is red when there is an alarm occurring.
		HDD: the LED flashes red when HDD is reading/writing.
		Tx/Rx: TX/RX LED flashes green when network connection is functioning normally.
2	USB Interface	Connects USB mouse or USE flash memory devices.
3	Composite Keys	1/MENU
		Enter numeral "1";
		Access the main menu interface.
		2/ABC/F1
		Enter numeral "2";
		Enter letters "ABC";
		The F1 button when used in a list field will select all items in the list.
		In PTZ Control mode, it will turn on/off PTZ light and when the image is zoomed in, the key is used to zoom out.
		3/DEF/F2
		Enter numeral "3";
		Enter letters "DEF";
		The F2 button is used to change the tab pages.
		In PTZ control mode, it zooms in the image.
		4/GHI/ESC
Enter numeral "4";		
Enter letters "GHI";		
Exit and back to the previous menu.		
5/JKL/EDIT		
Enter numeral "5";		
Enter letters "JKL";		
Delete characters before cursor;		
Check the checkbox and select the ON/OFF switch;		
Start/stop record clipping in playback.		
6/MNO/PLAY		
Enter numeral "6";		
Enter letters "MNO";		
Playback, for direct access to playback interface.		
7/PQRS/REC		
Enter numeral "7";		
Enter letters "PQRS";		

		8/TUV/PTZ	Open the manual record interface.
			Enter numeral “8”;
			Enter letters “TUV”;
		9/WXYZ/PREV	Access PTZ control interface.
			Enter numeral “9”;
			Enter letters “WXYZ”;
		0/A	Multi-channel display in live view.
			Enter numeral “0”;
			Shift the input methods in the editing text field. (Upper and lowercase, alphabet, symbols or numeric input).
4	SHIFT		Switch between the numeric or letter input and functions of the composite keys. (Input letter or numbers when the light is out; Realize functions when the light is red.)
5	Control Buttons	DIRECTION	In menu mode, the direction buttons are used to navigate between different fields and items and select setting parameters.
			In playback mode, the Up and Down buttons are used to speed up and slow down record playing, and the Left and Right buttons are used to move the recording 30s forwards or backwards.
			In the image setting interface, the up and down button can adjust the level bar of the image parameters.
			In live view mode, these buttons can be used to switch channels.
		ENTER	The Enter button is used to confirm selection in menu mode; or used to check checkbox fields and ON/OFF switch.
			In playback mode, it can be used to play or pause the video.
			In single-frame play mode, pressing the Enter button will play the video by a single frame.
			And in auto sequence view mode, the buttons can be used to pause or resume auto sequence.
6	IR Receiver		Receiver for IR remote.

Rear Panel

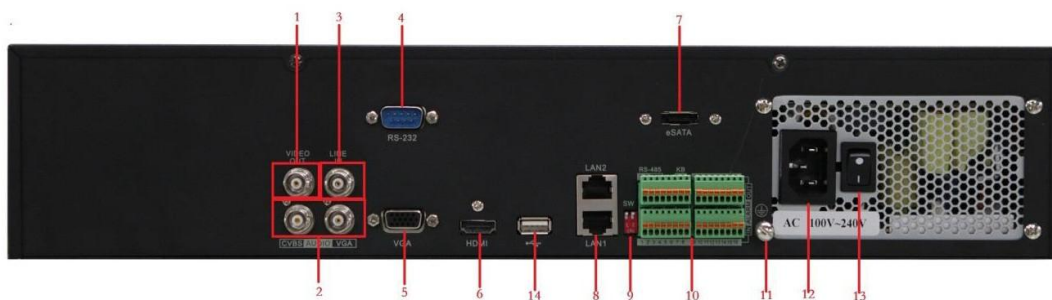

0700/0700-R

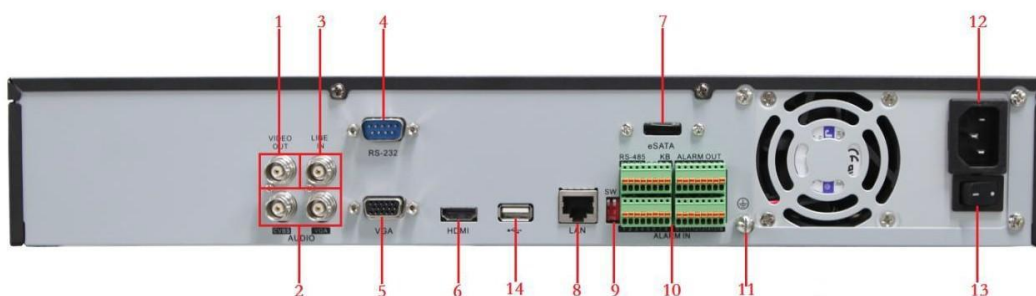

8800

No.	Item	Description
1	VIDEO OUT	BNC connector for video output.
2	CVBS AUDIO OUT	BNC connector for audio output. This connector is synchronized with CVBS video output.
	VGA AUDIO OUT	BNC connector for audio output. This connector is synchronized with VGA video output.
3	LINE IN	BNC connector for audio input.
4	RS-232 Interface	Connector for RS-232 devices.
5	VGA	DB9 connector for VGA output. Display local video output and menu.
6	HDMI	HDMI video output connector.
7	eSATA (Optional)	Connects external SATA HDD, CD/DVD-RM.
8	LAN Interface	1 network interface provided for 8800 and 2 network interfaces for 0700
9	Termination Switch	RS-485 termination switch. Up position is not terminated. Down position is terminated with 120Ω resistance.
10	RS-485 Interface	Connector for RS-485 devices. T+ and T- pins connect to R+ and R- pins of PTZ receiver respectively.
	Controller Port	D+, D- pin connects to Ta, Tb pin of controller. For cascading devices, the first NVR's D+, D- pin should be connected with the D+, D- pin of the next NVR.
	ALARM IN	Connector for alarm input.
	ALARM OUT	Connector for alarm output.
11	GROUND	Ground(needs to be connected when NVR starts up).
12	AC 100V ~ 240V	AC 100V ~ 240V power supply.
13	POWER	Switch for turning on/off the device.
14	USB interface	Universal Serial Bus (USB) ports for additional devices such as USB mouse and USB Hard Disk Drive (HDD).



8800-P8

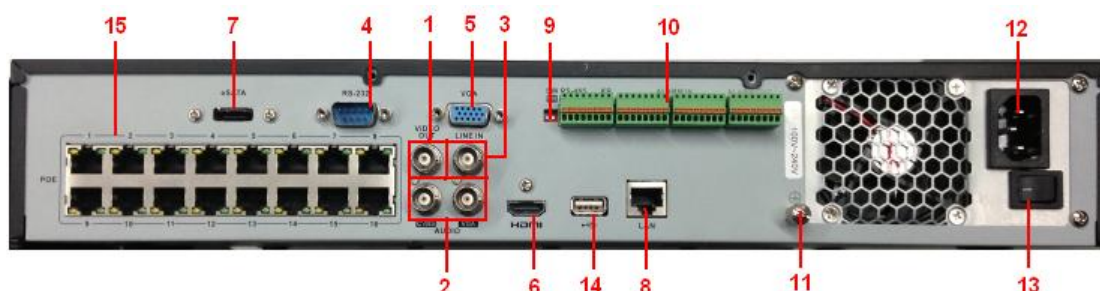

8800-P16

No.	Item	Description
1	VIDEO OUT	BNC connector for video output.
2	CVBS AUDIO OUT	BNC connector for audio output. This connector is synchronized with CVBS video output.
	VGA AUDIO OUT	BNC connector for audio output. This connector is synchronized with VGA video output.
3	LINE IN	BNC connector for audio input.
4	RS-232 Interface	Connector for RS-232 devices.
5	VGA	DB9 connector for VGA output. Display local video output and menu.
6	HDMI	HDMI video output connector.
7	eSATA (Optional)	Connects external SATA HDD, CD/DVD-RM.
8	LAN Interface	Connector for LAN (Local Area Network).
9	Termination Switch	RS-485 termination switch.
		Up position shows the RS-485 is not terminated. Down position shows the RS-485 is terminated with 120Ω resistance.
10	RS-485 Interface	Connector for RS-485 devices. T+ and T- pins connects to R+ and R- pins of PTZ receiver respectively.
	Controller Port	D+, D- pin connects to Ta, Tb pin of controller. For cascading devices, the first NVR's D+, D- pin should be connected with the D+, D- pin of the next NVR.
	ALARM IN	Connector for alarm input.
	ALARM OUT	Connector for alarm output.
11	GROUND	Ground (needs to be connected when NVR starts up).
12	AC 100V ~ 240V	AC 100V ~ 240V power supply.
13	POWER	Switch for turning on/off the device.
14	USB interface	Universal Serial Bus (USB) ports for additional devices such as USB mouse and USB Hard Disk Drive (HDD).
15	Network Interfaces with PoE function	Network interface for the cameras and to provide power over Ethernet.

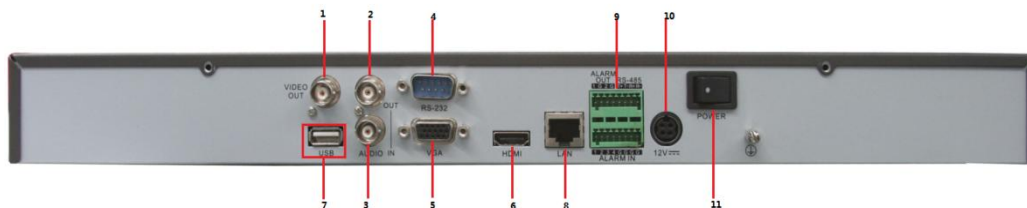

8716

No.	Item	Description
1	VIDEO OUT	BNC connector for video output.
2	AUDIO OUT	BNC connector for audio output.
3	AUDIO IN	BNC connector for audio input. (Also for two-way audio)
4	RS-232 Interface	Connector for RS-232 devices.
5	VGA	DB9 connector for VGA output. Display local video output and menu.
6	HDMI	HDMI video output connector.
7	USB	Connects USB disks and devices.
8	LAN Interface	1 network interface.
9	RS-485 Interface	Connector for RS-485 devices. T+ and T- pins connect to R+ and R- pins of PTZ receiver respectively.
	ALARM IN	Connector for alarm input.
	ALARM OUT	Connector for alarm output.
10	Power Supply	12VDC power supply.
11	Power Switch	Switch for turning on/off the device.

Peripheral Connections

Wiring of Alarm Input / Output

The alarm input/output interface of the NVR is shown as below:

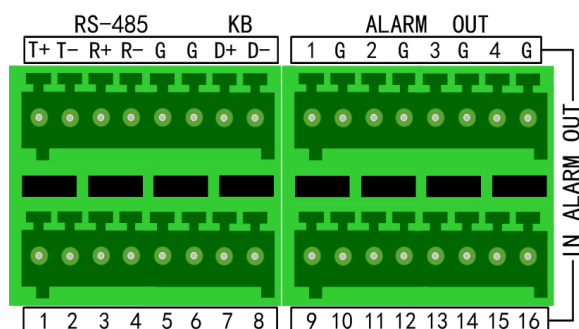

The alarm input is an open/closed relay. If the input is not an open/closed relay, follow the connection diagram below:

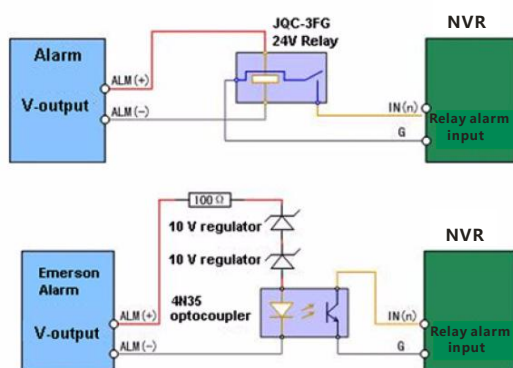

To connect to an alarm output (AC/DC load), use the following diagram:

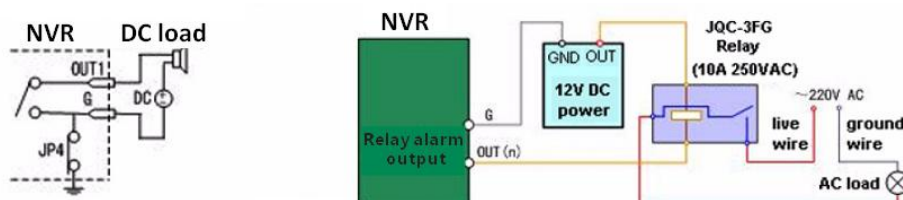

Connections for DC load

Connections for AC load

For DC load, JP4 can be used within the limit of 12V/1A safely. If the interface is connected to an AC load, JP4 should be left open. Use an external relay for safety (as shown in the figure above).

There are 4 jumpers (JP1, JP2, JP3, and JP4) on the motherboard, each corresponding with one alarm output. By default, jumpers are connected. To connect an AC load, jumpers should be removed.

Note: An external relay is needed to prevent electric shock when connecting to an AC load.

Using of Alarm Connectors

To connect alarm devices to the NVR:

1. Disconnect *pluggable block* from the ALARM IN /ALARM OUT terminal block.
2. Unfasten stop screws from the *pluggable block*, insert signal cables into slots and fasten stop screws. Ensure signal cables are in tight.
3. Connect *pluggable block* back into terminal block.

Controller Connection

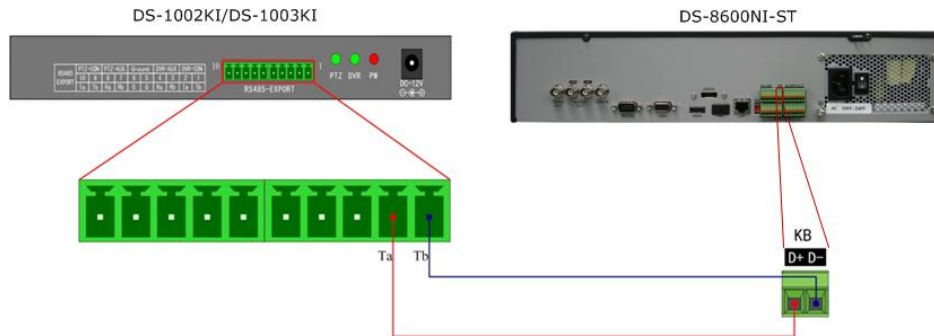

To connect a controller to the NVR:

1. Disconnect pluggable block from the KB terminal block.
2. Unfasten stop screws from the KB D+, D- *pluggable block*, insert signal cables into slots and fasten stop screws. Ensure signal cables are in tight.
3. Connect Ta on controller to D+ on terminal block and Tb on controller to D- on terminal block. Fasten stop screws.
4. Connect *pluggable block* back into terminal block.

Note: Make sure both the controller and NVR are grounded.

Specifications

Specifications of 0700

Model		0708	0716	0732	0764
Video/Audio input	IP video input	8-ch	16-ch	32-ch	64-ch
	Two-way audio	1-ch, BNC (2.0 Vp-p, 1kΩ)			
Video/Audio output	Recording resolution	5MP /3MP /1080P /UXGA /720P /VGA /4CIF /DCIF /2CIF /CIF /QCIF			
	Frame rate	Main stream: 25 fps (P) / 30 fps (N)			
		Sub-stream: 25 fps (P) / 30 fps (N)			
	CVBS output	1-ch, BNC (1.0 Vp-p, 75 Ω) Resolution: 704 × 576 (PAL); 704 × 480 (NTSC)			
	HDMI output	1-ch, resolution: 1920 × 1080P /60Hz, 1920×1080P /50Hz, 1600 × 1200/60Hz, 1280 × 1024 /60Hz, 1280 × 720 /60Hz, 1024 × 768 /60Hz			
	VGA output	1-ch, resolution: 1920 × 1080P /60Hz, 1600 × 1200 /60Hz, 1280 × 1024 /60Hz, 1280 × 720 /60Hz, 1024 × 768 /60Hz			
	Audio output	2-ch, BNC (Linear, 600Ω)			
	Playback resolution	5MP /3MP /1080P /UXGA /720P /VGA /4CIF /DCIF /2CIF /CIF /QCIF			
Synchronous playback	8-ch	16-ch	16-ch	16-ch	
Hard disk	SATA	8 SATA interfaces for 4 HDDs + 1 DVD-R/W (default), or 8HDDs			
	eSATA	1 eSATA interface			
	Capacity	Up to 4TB capacity for each HDD			
External interface	Network interface	2 RJ-45 10/100/1000 Mbps self-adaptive Ethernet interfaces			
	Serial interface	RS-232; RS-485; Keyboard			
	USB interface	3 × USB 2.0			
	Alarm in	16			
	Alarm out	4			
Others	Power supply	100 ~ 240 VAC, 6.3 A, 50 ~ 60 Hz			
	Consumption (without hard disk or DVD-R/W)	≤ 35 W	≤ 40 W	≤ 45 W	≤ 45 W
	Working temperature	-10 °C ~ +55 °C			
	Working humidity	10 % ~ 90 %			
	Chassis	19-inch rack-mounted 2U chassis			
	Dimensions (W × D × H)	445 × 470 × 90 mm (17.52" × 18.5" × 3.54")			
	Weight	≤ 8 Kg (17.64 lb) (without hard disk or DVD-R/W)			

Specifications of 0700-R

Model		0708-R	0716-R	0732-R	0764-R
Video/Audio input	IP video input	8-ch	16-ch	32-ch	64-ch
	Two-way audio	1-ch, BNC (2.0 V _{p-p} , 1kΩ)			
Video/Audio output	Recording resolution	5MP /3MP /1080P /UXGA /720P /VGA /4CIF /DCIF /2CIF /CIF /QCIF			
	Frame rate	Main stream: 25 fps (P) / 30 fps (N)			
		Sub-stream: 25 fps (P) / 30 fps (N)			
	CVBS output	1-ch, BNC (1.0 V _{p-p} , 75 Ω) Resolution: 704 × 576 (PAL); 704 × 480 (NTSC)			
	HDMI output	1-ch, resolution: 1920 × 1080P /60Hz, 1920 × 1080P /50Hz, 1600 × 1200 /60Hz, 1280 × 1024 /60Hz, 1280 × 720 /60Hz, 1024 × 768 /60Hz			
	VGA output	1-ch, resolution: 1920 × 1080P /60Hz, 1600 × 1200 /60Hz, 1280 × 1024 /60Hz, 1280 × 720 /60Hz, 1024 × 768 /60Hz			
	Audio output	2-ch, BNC (Linear, 600Ω)			
	Playback resolution	5MP /3MP /1080P /UXGA /720P /VGA /4CIF /DCIF /2CIF /CIF /QCIF			
	Synchronous playback	8-ch	16-ch	16-ch	16-ch
Hard disk	SATA	8 SATA interfaces for 4 HDDs + 1 DVD-R/W (default), or 8HDDs			
	eSATA	1 eSATA interface			
	Capacity	Up to 4TB capacity for each HDD			
Disk array	Array type	RAID0, RAID1, RAID5, RAID10			
	Number of array	4			
	Number of virtual disk	8			
External interface	Network interface	2 RJ-45 10 /100 /1000 Mbps self-adaptive Ethernet interfaces			
	Serial interface	RS-232; RS-485; Keyboard			
	USB interface	3 × USB 2.0			
	Alarm in	16			
	Alarm out	4			
Others	Power supply	100 ~ 240 VAC, 6.3 A, 50 ~ 60 Hz			
	Consumption (without hard disk or DVD-R/W)	≤ 35 W	≤ 40 W	≤ 45 W	≤ 45 W
	Working temperature	-10 °C ~ +55 °C			
	Working humidity	10 % ~ 90 %			
	Chassis	19-inch rack-mounted 2U chassis			
	Dimensions (W × D × H)	445 × 470 × 90 mm (17.52" × 18.5" × 3.54")			
	Weight	≤ 8 Kg (17.64 lb) (without hard disk or DVD-R/W)			

Specification of 8800

Model		8808	8816	8832
Video/Audio input	IP video input	8-ch	16-ch	32-ch
	Two-way audio	1-ch, BNC (2.0 Vp-p, 1k Ω)		
Video/Audio output	Recording resolution	5MP /3MP /1080P /UXGA /720P /VGA /4CIF /DCIF /2CIF /CIF /QCIF		
	Frame rate	Main stream: 25 fps (P) / 30 fps (N)		
		Sub-stream: 25 fps (P) / 30 fps (N)		
	CVBS output	1-ch, BNC (1.0 Vp-p, 75 Ω) Resolution: 704 \times 576 (PAL); 704 \times 480 (NTSC)		
	HDMI output	1-ch, resolution: 1920 \times 1080P /60Hz, 1920 \times 1080P /50Hz, 1600 \times 1200 /60Hz, 1280 \times 1024 /60Hz, 1280 \times 720 /60Hz, 1024 \times 768 /60Hz		
	VGA output	1-ch, resolution: 1920 \times 1080P /60Hz, 1600 \times 1200 /60Hz, 1280 \times 1024 /60Hz, 1280 \times 720 /60Hz, 1024 \times 768 /60Hz		
	Audio output	2-ch, BNC (Linear, 600 Ω)		
	Playback resolution	5MP /3MP /1080P /UXGA /720P /VGA /4CIF /DCIF /2CIF /CIF /QCIF		
Synchronous playback	8-ch	16-ch	16-ch	
Hard disk	SATA	4 SATA interfaces for 2 HDDs + 1 DVD-R/W (default), or 4HDDs		
	eSATA	1 eSATA interface		
	Capacity	Up to 4TB capacity for each HDD		
External interface	Network interface	1 RJ-45 10 /100 /1000 Mbps self-adaptive Ethernet interface		
	Serial interface	RS-232; RS-485; Keyboard		
	USB interface	3 \times USB 2.0		
	Alarm in	16		
	Alarm out	4		
Others	Power supply	100 ~ 240 VAC, 6.3 A, 50 ~ 60 Hz		
	Consumption (without hard disk or DVD-R/W)	\leq 35 W	\leq 40W	\leq 45 W
	Working temperature	-10 $^{\circ}$ C ~ +55 $^{\circ}$ C		
	Working humidity	10 % ~ 90 %		
	Chassis	19-inch rack-mounted 2U chassis		
	Dimensions (W \times D \times H)	445 \times 390 \times 90 mm		
	Weight	\leq 4 Kg (8.82 lb) (without hard disk or DVD-R/W)		

Specification of 8800-P8

Model		8808-P8	8816-P8	8832-P8
Video/Audio input	IP video input	8-ch	16-ch	32-ch
	Two-way audio	1-ch, BNC (2.0 Vp-p, 1kΩ)		
Video/Audio output	Recording resolution	5MP /3MP /1080P /UXGA /720P /VGA /4CIF /DCIF /2CIF /CIF /QCIF		
	Frame rate	Main stream: 25 fps (P) / 30 fps (N)		
		Sub-stream: 25 fps (P) / 30 fps (N)		
	CVBS output	1-ch, BNC (1.0 Vp-p, 75 Ω) Resolution: 704 × 576 (PAL); 704 × 480 (NTSC)		
	HDMI output	1-ch, resolution: 1920 × 1080P /60Hz, 1920 × 1080P /50Hz, 1600 × 1200 /60Hz, 1280 × 1024 /60Hz, 1280 × 720 /60Hz, 1024 × 768 /60Hz		
	VGA output	1-ch, resolution: 1920 × 1080P /60Hz, 1600 × 1200 /60Hz, 1280 × 1024 /60Hz, 1280 × 720 /60Hz, 1024 × 768 /60Hz		
	Audio output	2-ch, BNC (Linear, 600Ω)		
	Playback resolution	5MP /3MP /1080P /UXGA /720P /VGA /4CIF /DCIF /2CIF /CIF /QCIF		
Synchronous playback	8-ch	16-ch	16-ch	
Hard disk	SATA	4 SATA interfaces for 2 HDDs + 1 DVD-R/W (default), or 4HDDs		
	eSATA	1 eSATA interface		
	Capacity	Up to 4TB capacity for each HDD		
External interface	Network interface	1 RJ-45 10 /100 /1000 Mbps self-adaptive Ethernet interface		
		8 independent 100 Mbps PoE network interfaces		
	Serial interface	RS-232; RS-485; Keyboard		
	USB interface	3 × USB 2.0		
	Alarm in	16		
	Alarm out	4		
Others	Power supply	100 ~ 240 VAC, 6.3 A, 50 ~ 60 Hz		
	Consumption (without hard disk or DVD-R/W)	≤ 35 W	≤ 40W	≤ 45 W
	Working temperature	-10 °C ~ +55 °C		
	Working humidity	10 % ~ 90 %		
	Chassis	19-inch rack-mounted 2U chassis		
	Dimensions (W × D × H)	445 × 390 × 90 mm		
	Weight	≤ 8 Kg (17.64 lb) (without hard disk or DVD-R/W)		

Specification of 8800-P16

Model		8816-P16	8832-P16
Video/Audio input	IP video input	16-ch	32-ch
	Two-way audio	1-ch, BNC (2.0 Vp-p, 1kΩ)	
Video/Audio output	Recording resolution	5MP /3MP /1080P /UXGA /720P /VGA /4CIF /DCIF /2CIF /CIF /QCIF	
	Frame rate	Main stream: 25 fps (P) / 30 fps (N)	
		Sub-stream: 25 fps (P) / 30 fps (N)	
	CVBS output	1-ch, BNC (1.0 Vp-p, 75 Ω) Resolution: 704 × 576 (PAL); 704 × 480 (NTSC)	
	HDMI output	1-ch, resolution: 1920 × 1080P /60Hz, 1920 × 1080P /50Hz, 1600 × 1200 /60Hz, 1280 × 1024 /60Hz, 1280 × 720 /60Hz, 1024 × 768 /60Hz	
	VGA output	1-ch, resolution: 1920 × 1080P /60Hz, 1600 × 1200 /60Hz, 1280 × 1024 /60Hz, 1280 × 720 /60Hz, 1024 × 768 /60Hz	
	Audio output	2-ch, BNC (Linear, 600Ω)	
	Playback resolution	5MP /3MP /1080P /UXGA /720P /VGA /4CIF /DCIF /2CIF /CIF /QCIF	
Synchronous playback	16-ch	16-ch	
Hard disk	SATA	4 SATA interfaces for 2 HDDs + 1 DVD-R/W (default), or 4HDDs	
	eSATA	1 eSATA interface	
	Capacity	Up to 4TB capacity for each HDD	
External interface	Network interface	1 RJ-45 10 /100 /1000 Mbps self-adaptive Ethernet interface	
		16 independent 100 Mbps PoE network interfaces	
	Serial interface	RS-232; RS-485; Keyboard	
	USB interface	3 × USB 2.0	
	Alarm in	16	
	Alarm out	4	
Others	Power supply	100 ~ 240 VAC, 6.3 A, 50 ~ 60 Hz	
	Consumption (without hard disk or DVD-R/W)	≤ 40W	≤ 45 W
	Working temperature	-10 °C ~ +55 °C	
	Working humidity	10 % ~ 90 %	
	Chassis	19-inch rack-mounted 2U chassis	
	Dimensions (W × D × H)	445 × 390 × 90 mm	
	Weight	≤ 8 Kg (17.64 lb) (without hard disk or DVD-R/W)	

Specifications of 8700

Model		8716
Video/Audio input	IP video input	16-ch
	Audio in	1-ch, BNC (2.0 V _{p-p} , 1k Ω) (Two-way audio)
Video/Audio output	Recording resolution	5MP /3MP /1080P /UXGA /720P /VGA /4CIF /DCIF /2CIF /CIF /QCIF
	Frame rate	Main stream: 25 fps (P) / 30 fps (N)
		Sub-stream: 25 fps (P) / 30 fps (N)
	CVBS output	1-ch, BNC (1.0 V _{p-p} , 75 Ω) Resolution: 704 \times 576 (PAL); 704 \times 480 (NTSC)
	HDMI output	1-ch, resolution: 1920 \times 1080P /60Hz, 1920 \times 1080P /50Hz, 1600 \times 1200 /60Hz, 1280 \times 1024 /60Hz, 1280 \times 720 /60Hz, 1024 \times 768 /60Hz
	VGA output	1-ch, resolution: 1920 \times 1080P /60Hz, 1600 \times 1200 /60Hz, 1280 \times 1024 /60Hz, 1280 \times 720 /60Hz, 1024 \times 768 /60Hz
	Audio output	1-ch, BNC (Linear, 600 Ω)
	Playback resolution	5MP /3MP /1080P /UXGA /720P /VGA /4CIF /DCIF /2CIF /CIF /QCIF
Synchronous playback	16-ch	
Hard disk	SATA	2 SATA interfaces
	Capacity	Each interface supports up to 4TB capacity for recording
External interface	Network interface	1 RJ-45 10 /100 /1000 Mbps self-adaptive Ethernet interface
	Serial interface	RS-232; RS-485;
	USB interface	2 \times USB 2.0
	Alarm in	4
	Alarm out	2
Others	Power supply	12 VDC
	Consumption	\leq 13 W (without hard disk or DVD-R/W)
	Working temperature	-10 $^{\circ}$ C \sim +55 $^{\circ}$ C
	Working humidity	10 % \sim 90 %
	Chassis	19-inch rack-mounted 1U chassis
	Dimensions (W \times D \times H)	445 \times 261 \times 44.5 mm
	Weight	\leq 4 Kg (8.82 lb) (without hard disk or DVD-R/W)

Specifications of 8700-P8

Model		8708-P8	8716-P8
Video/Audio input	IP video input	8-ch	16-ch
	Audio in	1-ch, BNC (2.0 Vp-p, 1k Ω) (Two-way audio)	
Video/Audio output	Recording resolution	5MP /3MP /1080P /UXGA /720P /VGA /4CIF /DCIF /2CIF /CIF /QCIF	
	Frame rate	Main stream: 25 fps (P) / 30 fps (N)	
		Sub-stream: 25 fps (P) / 30 fps (N)	
	CVBS output	1-ch, BNC (1.0 Vp-p, 75 Ω) Resolution: 704 \times 576 (PAL); 704 \times 480 (NTSC)	
	HDMI output	1-ch, resolution: 1920 \times 1080P /60Hz, 1920 \times 1080P /50Hz, 1600 \times 1200 /60Hz, 1280 \times 1024 /60Hz, 1280 \times 720 /60Hz, 1024 \times 768 /60Hz	
	VGA output	1-ch, resolution: 1920 \times 1080P /60Hz, 1600 \times 1200 /60Hz, 1280 \times 1024 /60Hz, 1280 \times 720 /60Hz, 1024 \times 768 /60Hz	
	Audio output	1-ch, BNC (Linear, 600 Ω)	
	Playback resolution	5MP /3MP /1080P /UXGA /720P /VGA /4CIF /DCIF /2CIF /CIF /QCIF	
Synchronous playback	8-ch	16-ch	
Hard disk	SATA	2 SATA interfaces	
	Capacity	Each interface supports up to 4TB capacity for recording	
External interface	Network interface	1 RJ-45 10 /100 /1000 Mbps self-adaptive Ethernet interface	
		8 independent 100 Mbps PoE network interfaces	
	Serial interface	RS-232; RS-485;	
	USB interface	2 \times USB 2.0	
	Alarm in	4	
	Alarm out	2	
Others	Power supply	12 VDC	
	Consumption	\leq 13 W (without hard disk or DVD-R/W)	
	Working temperature	-10 $^{\circ}$ C ~ +55 $^{\circ}$ C	
	Working humidity	10 % ~ 90 %	
	Chassis	19-inch rack-mounted 1U chassis	
	Dimensions (W \times D \times H)	445 \times 261 \times 44.5 mm	
	Weight	\leq 4 Kg (8.82 lb) (without hard disk or DVD-R/W)	

HDD Storage Calculation Chart

The following chart shows an estimation of storage space used based on recording at one channel for an hour at a fixed bit rate.

Bit Rate	Storage Used
96K	42M
128K	56M
160K	70M
192K	84M
224K	98M
256K	112M
320K	140M
384K	168M
448K	196M
512K	225M
640K	281M
768K	337M
896K	393M
1024K	450M
1280K	562M
1536K	675M
1792K	787M
2048K	900M

Note: Please note that supplied values for storage space used is just for reference. The storage values in the chart are estimated by formulas and may have some deviation from actual value.

Menu Operation

Menu Structure

The menu structure of the 0700/8800/8700 Series NVR:

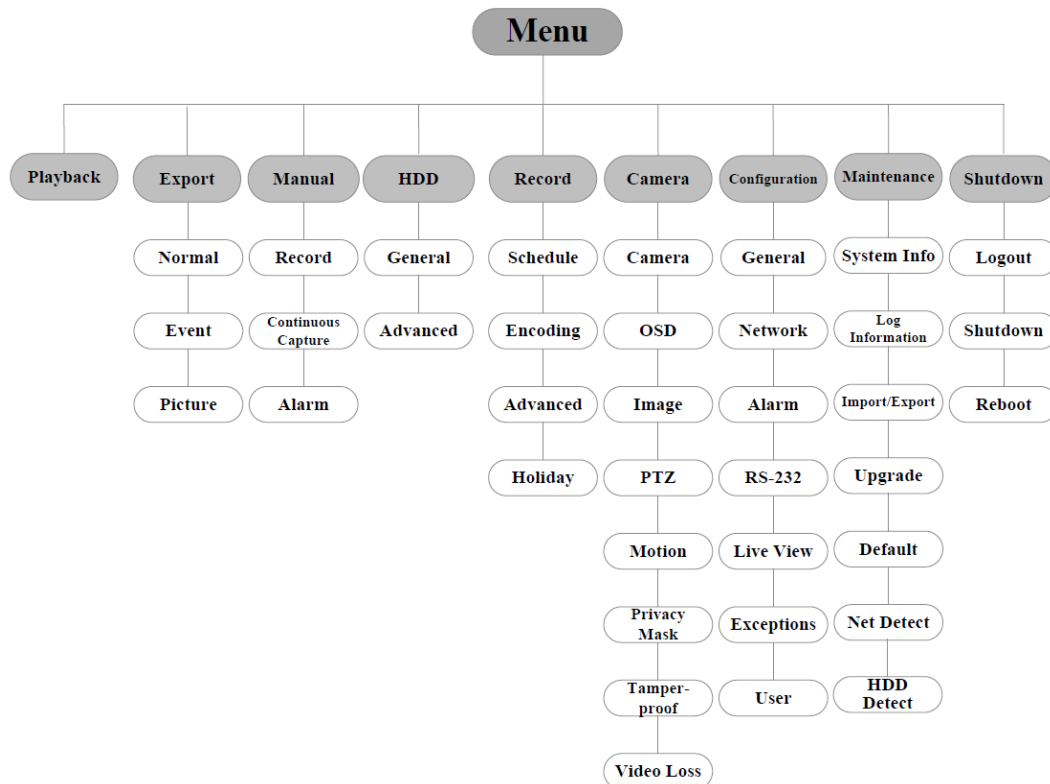

The menu structure of the 0700-R Series NVR:

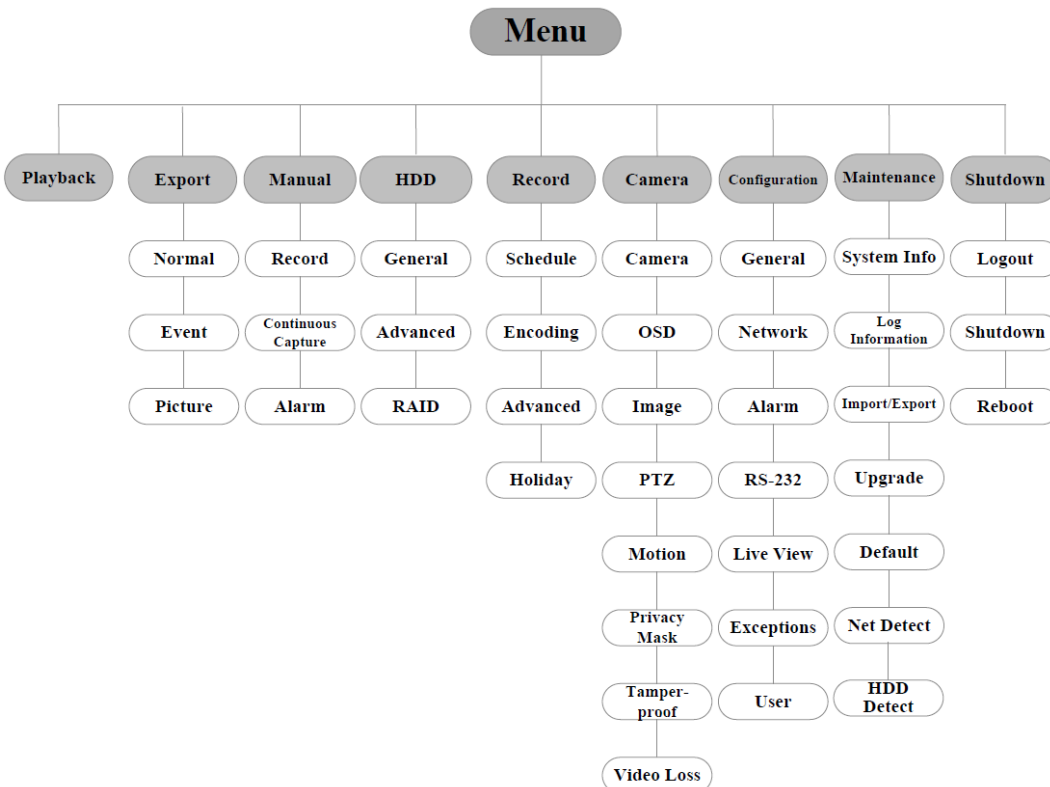

Startup and Shutdown

Proper startup and shutdown procedures are crucial to expanding the life of the NVR.

To start your NVR:

1. Check the power supply is plugged into an electrical outlet. It is **HIGHLY** recommended that an Uninterruptible Power Supply (UPS) be used in conjunction with the device. The Power LED on the front panel should be red, indicating the device gets the power supply.
2. Press the POWER button on the front panel. The Power LED should turn green. The unit will begin to start.

To shut down the NVR:

1. Enter the Shutdown menu.

Menu > Shutdown

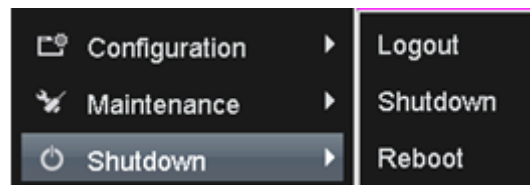

Shutdown Menu

2. Select the **Shutdown** button.
3. Click the **Yes** button.

Using the Start Wizard

By default, the Setup Wizard starts once the NVR has loaded, as shown in Figure below.

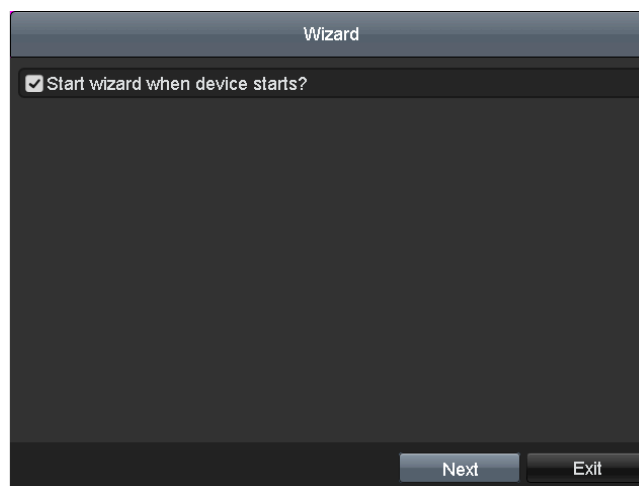

Start Wizard Interface

Operating the Setup Wizard:

1. The Setup Wizard can walk you through some important settings of the NVR. If you don't want to use the Setup Wizard at that moment, click the **Cancel** button. You can also choose to use the Setup Wizard next time by leaving the "Start wizard when NVR starts?" checkbox checked.
2. Click **Next** button on the Wizard window to enter the **Login** window.

Wizard	
Admin Password	*****
New Admin Password	<input type="checkbox"/>
New Password	
Confirm	

Previous Next Exit

Login Window

3. Enter the admin password. By default, the password is 12345.
4. To change the admin password, check the **New Admin Password** checkbox. Enter the new password and confirm the password in the given fields.
5. Click the **Next** button to enter the date and time settings window.

Wizard	
Time Zone	(GMT+08:00) Beijing, Urumqi, Singapore
Date Format	DD-MM-YYYY
System Date	06-09-2013
System Time	18:04:48

Previous Next Exit

Date and Time Settings

6. After the time settings, click **Next** button which takes you back to the Network Setup Wizard window.

Wizard	
Working Mode	Multi-address
Select NIC	LAN1
NIC Type	10M/100M/1000M Self-adaptive
Enable DHCP	<input type="checkbox"/>
IPv4 Address	172 . 6 . 21 . 110
IPv4 Subnet Mask	255 . 255 . 255 . 0
IPv4 Default Gateway	172 . 6 . 21 . 1
Preferred DNS Server	
Alternate DNS Server	
Default Route	LAN1
<input type="button" value="Previous"/> <input type="button" value="Next"/> <input type="button" value="Cancel"/>	

0700

Wizard	
NIC Type	10M/100M/1000M Self-adaptive
Enable DHCP	<input type="checkbox"/>
IPv4 Address	192 . 168 . 1 . 250
IPv4 Subnet Mask	255 . 255 . 255 . 0
IPv4 Default Gateway	192 . 168 . 10 . 1
Preferred DNS Serv...	
Alternate DNS Server	
<input type="button" value="Previous"/> <input type="button" value="Next"/> <input type="button" value="Exit"/>	

8700/8800

Network Configuration

Note: Dual-NIC is only supported by 0700 series device. And for 8700/8800-P8 series NVR, the internal NIC IPv4 address should be configured for the cameras connecting to the PoE network interface of the NVR.

7. Click **Next** button after you configured the network parameters, which takes you to the Array Management window (supported by 0700-R series only).

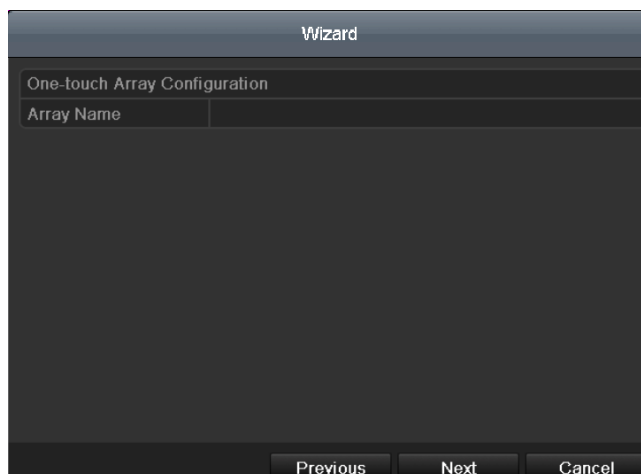

Array Management

8. Click **Next** button after you configured the network parameters, which takes you to the HDD Management window.

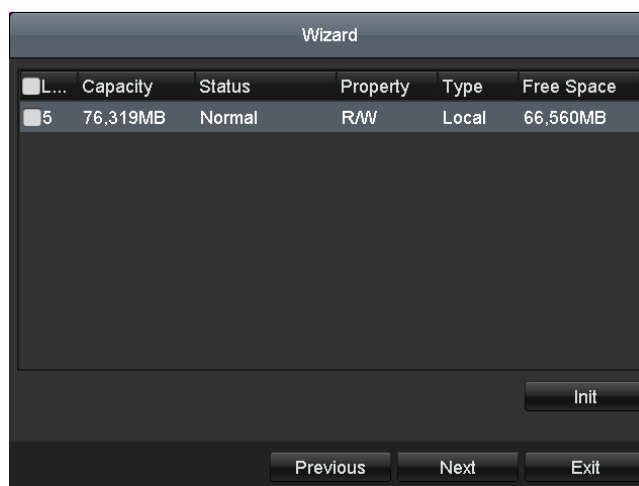

HDD Management

9. To initialize the HDD, click the **Init** button. Initialization removes all the data saved in the HDD.
10. Click **Next** button. You enter the Adding IP Camera interface.
11. Click **Search** to find online IP Camera. Select the IP camera to be added, and click the **Add** button.

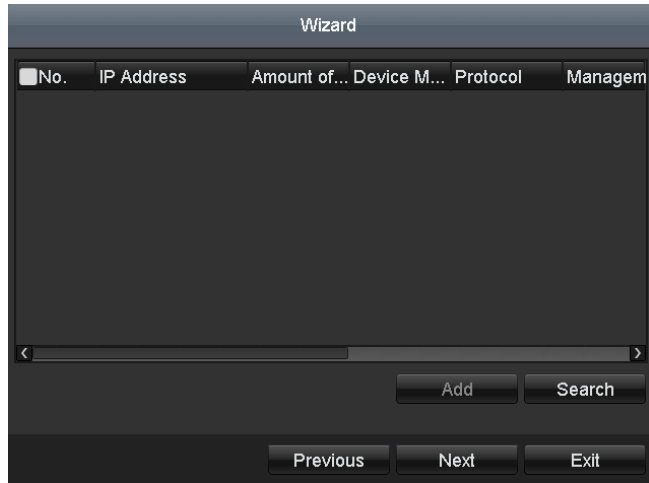

Search for IP Cameras

12. Click **Next** button. Configure the recording for the searched IP Cameras.



Record Settings

13. Click **Copy** to copy the settings to other channels.

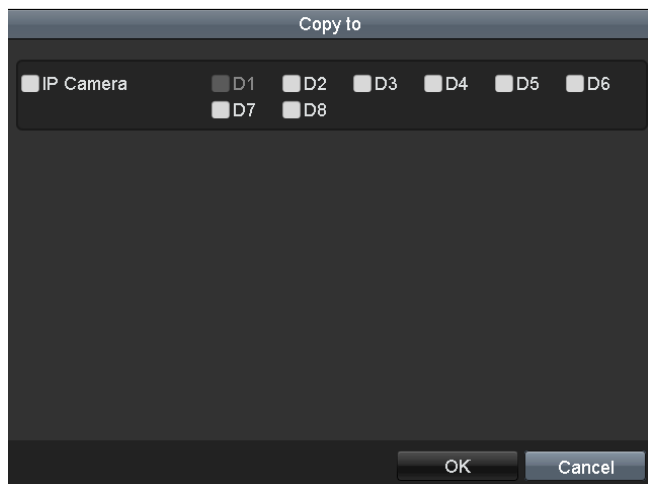

Copy Record Settings

14. Click **OK** to complete the startup Setup Wizard.

Live View

Some icons are provided on screen in Live View mode to indicate different camera status. These icons include:

Live View Icons

In the live view mode, there are icons at the right top of the screen for each channel, showing the status of the record and alarm in the channel, so that you can find problems as soon as possible.



Alarm (video loss, tampering, motion detection or sensor alarm).



Record (manual record, schedule record, motion detection or alarm triggered record)



Alarm & Record

Adding and Configuring IP Cameras

You should add and configure the online IP cameras to enable the live view and recording function.

Adding IP Cameras

You can search and add the online IP cameras by following the startup wizard, or according to the following steps.

Steps:

1. Enter the Camera Management interface.

Menu> Camera> Camera

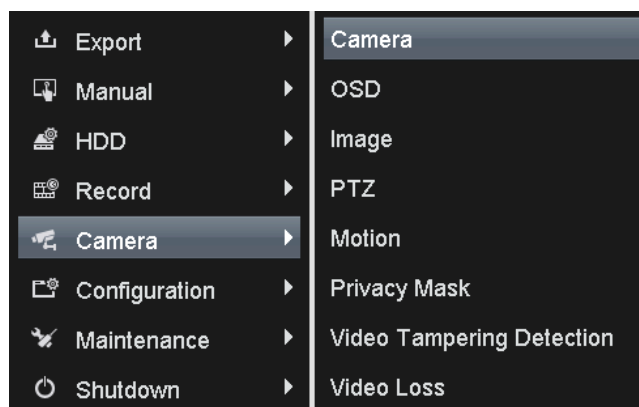

Main Menu

2. To add the online cameras with same network segment:
 - 1) Click **Search** to search the online cameras.

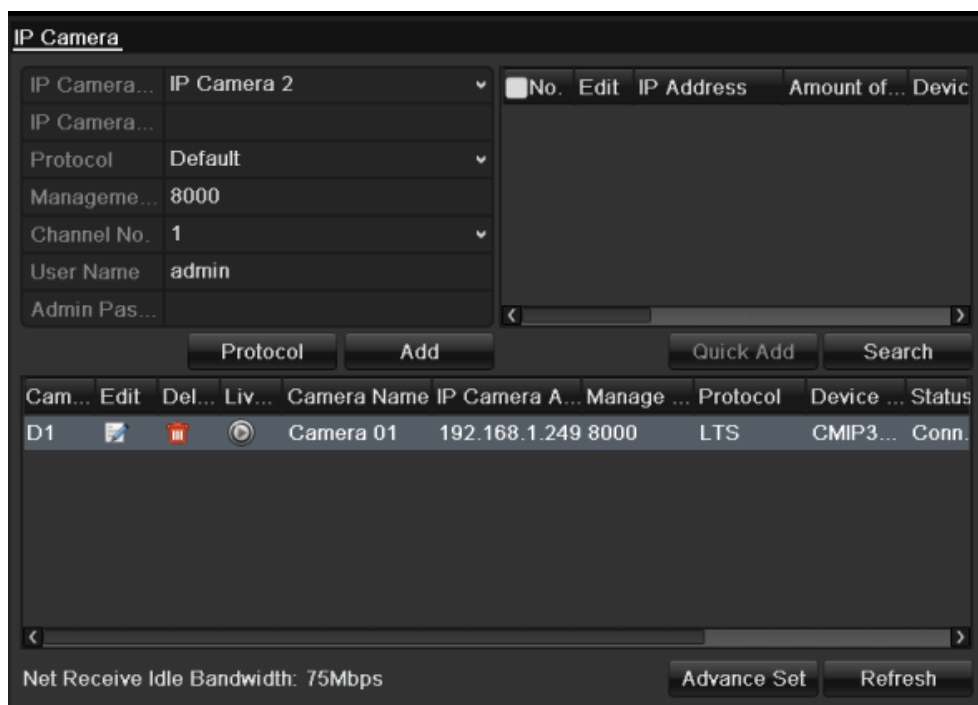

Camera Settings Interface

- 2) Check the checkbox of certain cameras to be added.
- 3) Click **Quick Add** to add the camera.
3. To add other IP cameras:
 - 1) On the left side of the interface, you can enter the IP address, protocol, management port, and other information of the IP camera to be added.
 - 2) Click **Add** to add the camera.

Note: If you check the Synchronize IP Camera checkbox, the default settings of the NVR for the IP camera is applied to the added camera.

Configuring Basic Parameters of IP Cameras

After the adding of the IP cameras, the basic information of the camera lists in the page, and you can configure the basic setting of the IP cameras.

Steps:

1. Click the  icon to edit the parameters; you can edit the IP address, protocol and other parameters.

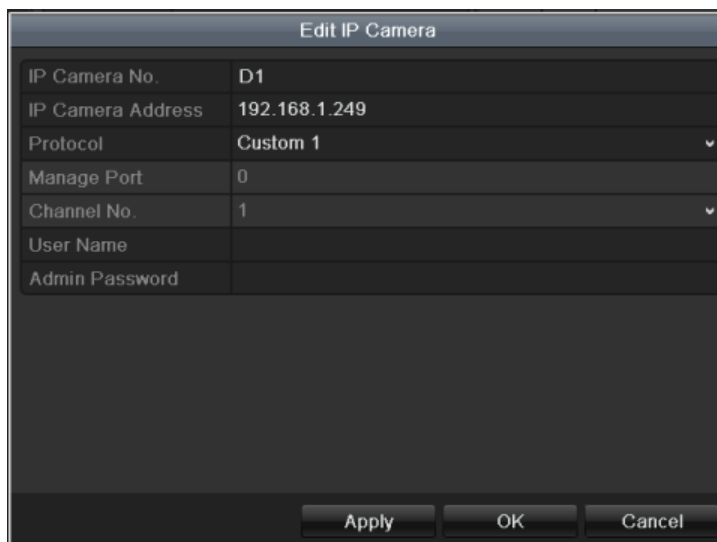

Edit the Parameters

2. Click apply to save the settings and click OK to exit the editing interface.

To edit more parameters:

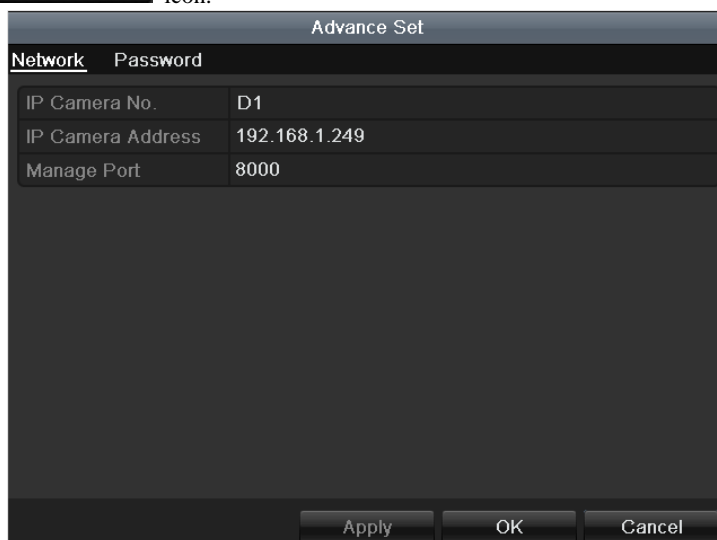

1. Click the **Advance Set** icon.



Network Configuration of the Camera

2. You can edit the network information and the password of the camera.
3. Click **Apply** to save the settings and click **OK** to exit the interface.

Explanation of the icons:

		
Edit basic parameters of the camera	Delete the IP camera	Get the live view of the camera

PTZ Control

Follow the procedure to set the parameters for PTZ. The configuring of the PTZ parameters should be done before you set the PTZ camera.

Before you start, please check that the PTZ and the NVR are connected properly through RS-485 interface.

PTZ Settings

Steps:

1. Enter the PTZ Settings interface.

Menu >Camera> PTZ

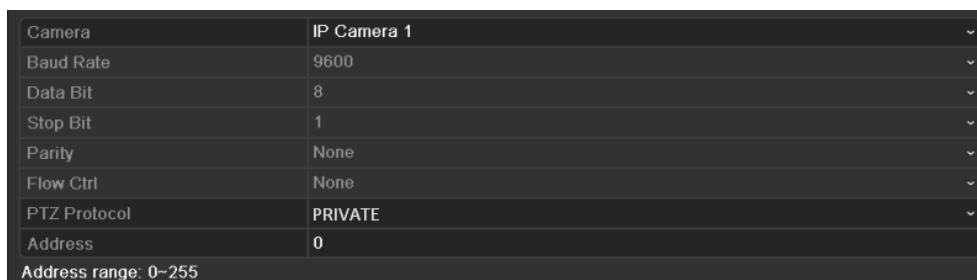

Camera Settings Interface

2. Choose the camera for PTZ setting next to **Camera** label.
3. Enter the parameters of the PTZ camera.
Note: All the parameters should be exactly the same as the PTZ camera parameters.
4. Click **Copy** if you want to configure same settings to other PTZ cameras.
5. Click the **Apply** button to save and exit the interface.







PTZ Control













In the Live View mode, you can press the PTZ Control button on the front panel or on the remote, or choose the PTZ Control icon  to enter the PTZ panel.



PTZ Control panel

Description of the PTZ panel icons

Icon	Description	Icon	Description	Icon	Description
	Direction button and the auto-cycle button		Zoom+, Focus+, Iris+		Zoom-, Focus-, Iris-
	The speed of the PTZ movement		Light on/off		Wiper on/off

Icon	Description	Icon	Description	Icon	Description
	3D-Zoom		Image Centralization		Preset
	Patrol		Pattern		Menu
	Previous item		Next item		Start pattern/patrol
	Stop the patrol or pattern movement		Minimize windows		Exit

Playback

Play back the record files of a specific channel in the live view menu. Channel switch is supported.

Instant playback by channel

Choose a channel under live view using the mouse and click the  button in the shortcut operation menu.

Note: Only record files recorded during the past five minutes on this channel will be played back.



Instant Playback Interface

Playback by channel

Steps:

1. Enter the Playback menu.
 Mouse: right click a channel in live view mode and select Playback from the menu.

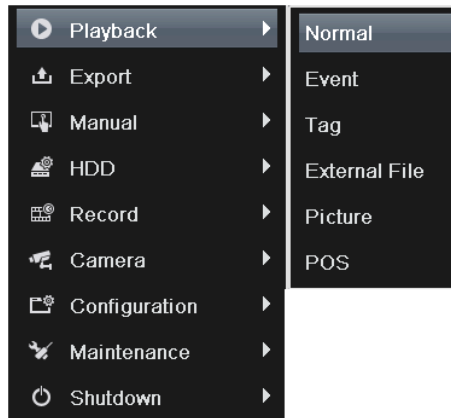

Right-click Menu under Live View

Front Panel: press PLAY button to play back record files of the channel under single-screen live view. Under multi-screen live view, record files of the top left channel (not masked) will be played back.

Note: pressing numerical buttons will switch playback to related channels during playback process.

2. Playback management.

The toolbar in the bottom part of Playback interface can be used to control playing process.



Playback Interface

Just check the channel or channels if you want to switch playback to another channel or execute simultaneous playback of multiple channels.

Backup

Recorded files can be backed up to various devices, such as USB flash drives, USB HDDs or a DVD writer.

Steps:

1. Enter Video Export interface.

Choose the channel(s) you want to back up and click on the **Quick Export** button.

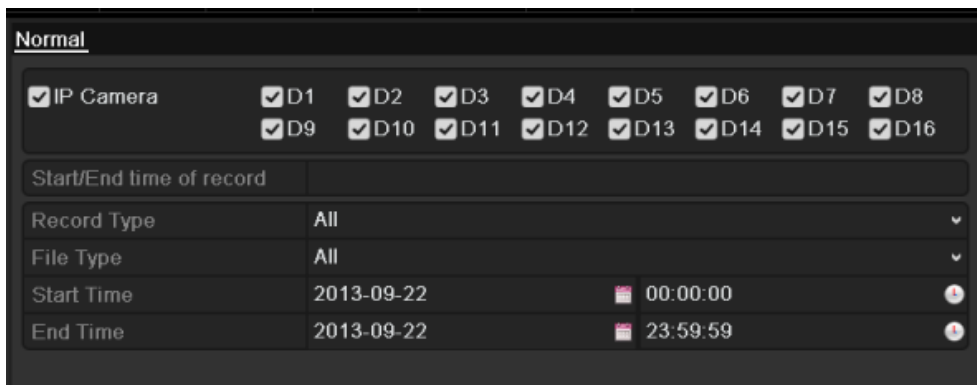

Quick Export Interface

2. Enter Export interface, choose backup device and press **Export** button to start exporting.

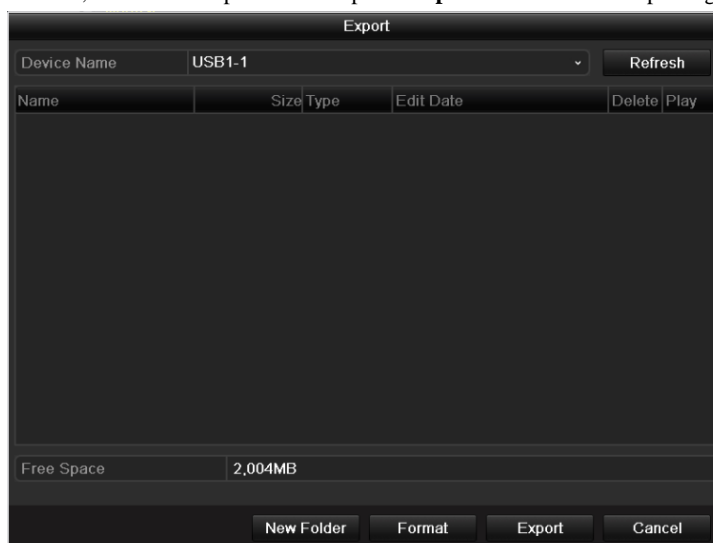

Quick Export using USB1-1

3. Check backup result.
Choose the record file in Export interface and press button  to check it.

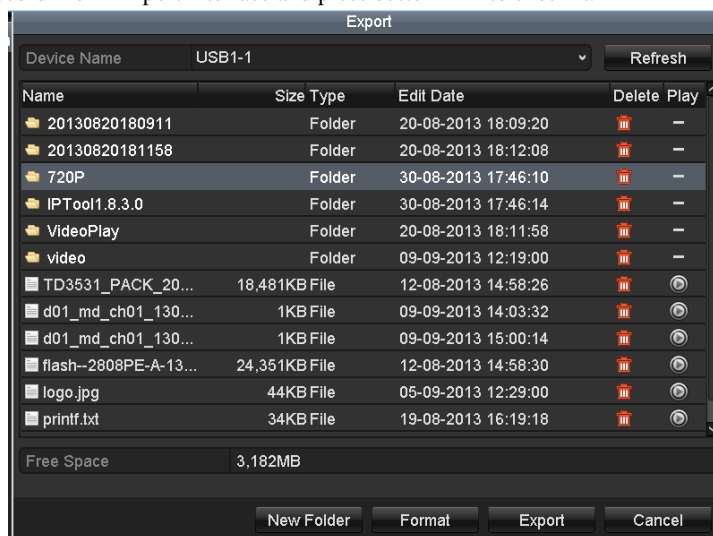

Checkup of Quick Export Result Using USB1-1

Accessing by Web Browser

Logging In

If the device has successfully connected to the network, you can get access to the device via web browser. Open web browser, input the IP address of the device and then press Enter. The login interface appears.



Input the user name and password, and click the Login button.

Notes:

1. The default IP address is 192.0.0.64.
2. The default user name is admin, and password is 12345.
3. You may use one of the following listed web browsers: Internet Explorer 6.0, Internet Explorer 7.0, Internet Explorer 8.0, Internet Explorer 9.0, Internet Explorer 10.0, Apple Safari, Mozilla Firefox, and Google Chrome.
4. The supported resolutions include 1024*768 and above.

When you log in for the first time, the system will remind you to install the Plug-in control. After the installation, you can configure and manage the device remotely.

Live View

The live view interface appears by default when you log in the device.

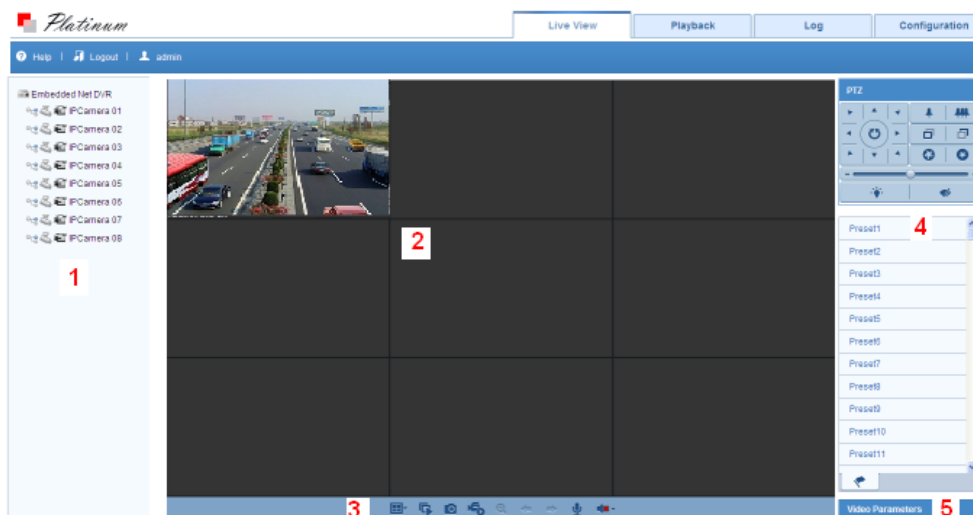

Interface Introduction

- ① Camera List: Displays the list of cameras and the playing and recording status of each camera.
- ② Live View Window: Displays the image of camera, and multi-window division is supported.
- ③ Play Control Bar: Play control operations are supported.
- ④ PTZ Control: Pan, tilt, zoom operations are supported, as well as preset editing and calling.

Note: PTZ function can only be realized if the connected camera supports PTZ control.











- ⑤ Video Parameters Configuration: Brightness, contrast, saturation and other parameters of the image can be modified.

Start Live View

Steps:

1. In the live view window, select a playing window by clicking the mouse.
2. Double-click a camera from the device list to start the live view.
3. You can click the  button on the toolbar to start the live view of all cameras on the device list.

Refer to the following table for the description of buttons on the live view window:

Icon	Description	Icon	Description
	Select the window-division mode		Start/Stop all live view
	Capture pictures in the live view mode		Start/Stop all recording
	Previous page		Next page
	Open/Close audio		Start/Stop two-way audio
	Adjust volume		Enable/Disable digital zoom
	Full-screen		

Recording

Before you start

Make sure the device is connected with HDD or network disk, and the HDD or network disk has been initialized for the first time to use.

Two recording types can be configured: Manual and Scheduled. The following section introduces the configuration of scheduled recording.

Steps:

1. Click Remote Configuration> Camera Settings> Record Schedule to enter Record Schedule settings interface.
2. Select the camera to configure the record schedule.
3. Check the checkbox of **Enable Record Schedule** to enable recording schedule.
4. Click **Edit** to edit record schedule.
5. Choose the day in a week to configure scheduled recording.
 - 1) Configure All Day or Customize record:
 - If you want to configure the all-day recording, please check the **All Day** checkbox.
 - If you want to record in different time sections, check the **Customize** checkbox. Set the **Start Time** and **End Time**.
6. Click **Advanced** to configure advanced record parameters.
7. Optionally, check the checkboxes of other cameras to copy the settings to.
8. Click **Save** to validate the above settings.

Note: The time of each segment can't be overlapped. Up to 8 segments can be configured.

Playback



Interface Introduction

- ① Camera List: Displays the list of cameras and the playing status of each camera.
- ② Playback Window: Displays the video of camera.
- ③ Play Control Bar: Play control operations are supported.
- ④ Time Line: Displays the time bar and the records marked with different colors.
- ⑤ Playback Status: Displays the playback status, including camera No. and playback speed.
- ⑥ Calendar: You can select the date to play.











Start Playback

Steps:



1. Click **Playback** on the menu bar to enter playback interface.
2. Click the camera from the device list for playback.
3. Select the date from the calendar and click **Search**.

Note: The day with record will be marked like 9.

4. Click the  button to play the video file searched on the current date.
5. Use the buttons on the toolbar to operate in playback mode.

Button	Description	Button	Description
	Play/Pause		Stop
	Slow down		Speed up
	Play by single frame		Capture
	Stop All Playback		Download
	Video Clip		Open/Close audio
	Full-screen		

6. You can drag the progress bar with the mouse to locate the exact playback point. You can also input the time

in the textbox : :  and click  button to locate the playback point.

The color of the video on the progress bar stands for the different video types.

Command Schedule Recording Alarm Recording Manual Recording

Log

You can view and export the log files at any time, including operation, alarm, exception and information of device.

Before you start

The Log function can be realized only when the device is connected with HDD or network disk. And make sure the HDD or network disk has been initialized for the first time to use.

Steps:

1. Click Log on the menu bar to enter the Log interface.

No.	Time	Major Type	Minor Type	Channel No.	Local/Remote User	Remote Host IP
1	2013-09-11 08:58:14	Operation	Power On			0.0.0.0
2	2013-09-11 08:58:14	Information	HDD Information			0.0.0.0
3	2013-09-11 08:58:18	Operation	Local Login		admin	0.0.0.0
4	2013-09-11 08:58:19	Exception	IP Address Conflicted			0.0.0.0
5	2013-09-11 08:58:39	Information	System Running State			0.0.0.0
6	2013-09-11 08:58:40	Exception	IP Camera Disconnect			0.0.0.0
7	2013-09-11 08:58:40	Exception	IP Camera Disconnect			0.0.0.0
8	2013-09-11 08:58:40	Exception	IP Camera Disconnect			0.0.0.0
9	2013-09-11 08:58:40	Exception	IP Camera Disconnect			0.0.0.0
10	2013-09-11 08:58:40	Exception	IP Camera Disconnect			0.0.0.0
11	2013-09-11 08:58:40	Exception	IP Camera Disconnect			0.0.0.0
12	2013-09-11 08:58:42	Information	S.M.A.R.T. Information	5		0.0.0.0
13	2013-09-11 08:58:49	Exception	IP Camera Disconnect			0.0.0.0
14	2013-09-11 08:58:49	Exception	Video Signal Loss	D1		0.0.0.0
15	2013-09-11 08:58:49	Exception	IP Camera Disconnect			0.0.0.0
16	2013-09-11 09:09:39	Information	System Running State			0.0.0.0
17	2013-09-11 09:18:38	Information	System Running State			0.0.0.0
18	2013-09-11 09:21:27	Operation	Local: Set IP Camera		admin	0.0.0.0
19	2013-09-11 09:22:11	Operation	Local: Set IP Camera		admin	0.0.0.0

2. Set the log search conditions to refine your search, including the Major Type, Minor Type, Start Time and End Time.
3. Click the **Search** button to start searching log files.
4. The matched log files will be displayed on the list shown below.

Note: Up to 100 log files can be displayed on each page.

You can click the  Save Log button to save the searched log files to local directory.