



Video Solutions for Security Professionals

Platinum Q1/Q2 2026



**Outdoor Box
ALL-IN-ONE**

**AI Color 24/7
CLEARER
Anti-Corrosion**



**5-Lens Instadome
EASIER**



**DeepVision
SMARTER**

**Panoramic
WIDER**

Biker with Backpack



Platinum Product Tiers | Best Selling IP and Video Surveillance

IP Cameras

AI Color 24/7 Pg 15-17



Color 24/7 Pg 18-21



Value Pg 29-33



Entry Pg 34-37



Specialty Cameras

Fisheye Pg 25



Panoramic/ Multi-sensor Pg 23-25



PTZ Pg 26-28



LPR Pg 21



Speaker Pg 22



NVR

DeepVision Pg 8-9



Enterprise Pg 11



Professional Pg 12



TVI

Color 24/7 with Active Deterrence Pg 41-42



Standard Pg 43-45



DVR

Enterprise Pg 38



Professional Pg 39-40



Defendas Access Control

Defendas Access Control Pg 46-47



Intercom & Access Control

Intercom/Access Control Pg 48-51



Accessories

Accessories Pg 52-58



What Makes Us Stand Out

Since 2009

Founded in 2009, LTS provides industry-leading security solutions and value-added services in video surveillance. We offer a comprehensive range of products, including cameras, intercoms, access control systems, accessories, mobile apps, and software. With offices located nationwide across the United States, we provide same-day pickup, fast shipping, and timely delivery.

First-class Service

- Well-stocked Inventory
- Same Day Delivery
- New Technology Demos
- Shop Online 24/7
- Local Order Pick up
- Membership Rewards
- Free Shipping Available
- Seamless RMA Process

100+ New Products Released Annually

We offer a wide range of high-quality products for diverse applications.

90K Customers Served Annually

120+ Sales/ Techs





















- Free Security Solution Consultation
- Sales & tech support from 9am to 9pm ET

200,000+ sq ft Warehouse Space

Global Supply Chain



Icon Glossary

- | | | | |
|------------------------------------------------------------------------------------|------------------------------------------|-------------------------------------------------------------------------------------|-------------------------------------------------------|
|  | AI Color 24/7 |  | Human / Vehicle Detection |
|  | Color 24/7 |  | VCA 3.0 Advanced
Human / Vehicle Detection |
|  | Hybrid Illumination:
IR + White Light |  | VCA 2.0
Human / Vehicle Detection |
|  | Active Deterrence |  | Direct-Search |
|  | Two-Way Audio |  | Smart Tracking with
Human / Vehicle Classification |
|  | Built-in Speaker |  | Facial Recognition |
|  | Built-in Microphone |  | Face Capture |
|  | InstaDome |  | Fisheye Lens |
|  | Anti-Corrosion |  | Wi-Fi |
|  | Vandal Resistant |  | RAID Supported |
|  | License Plate Recognition | | |

Platinum Naming Rules

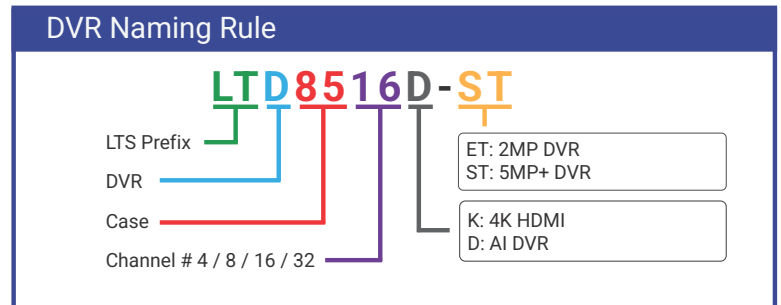
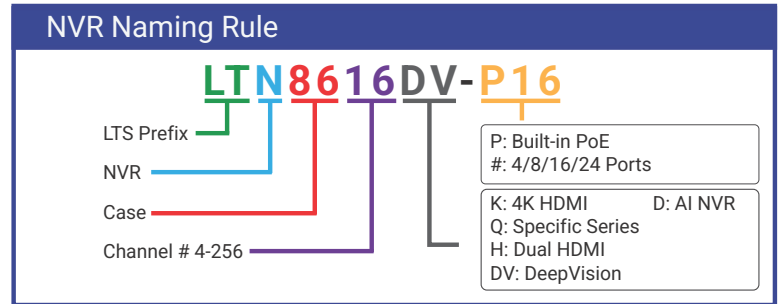
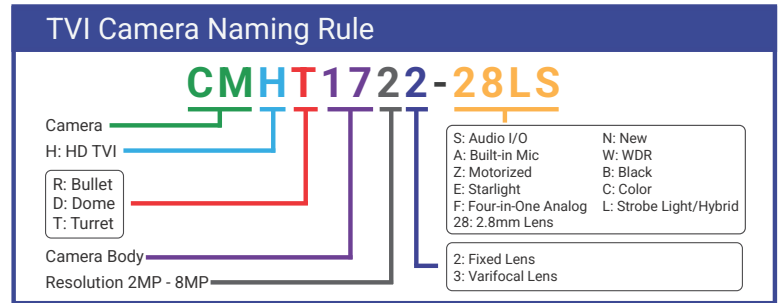
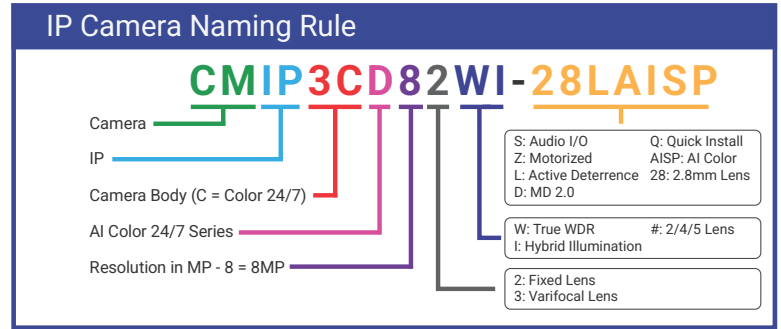

Platinum End-to-End Solution

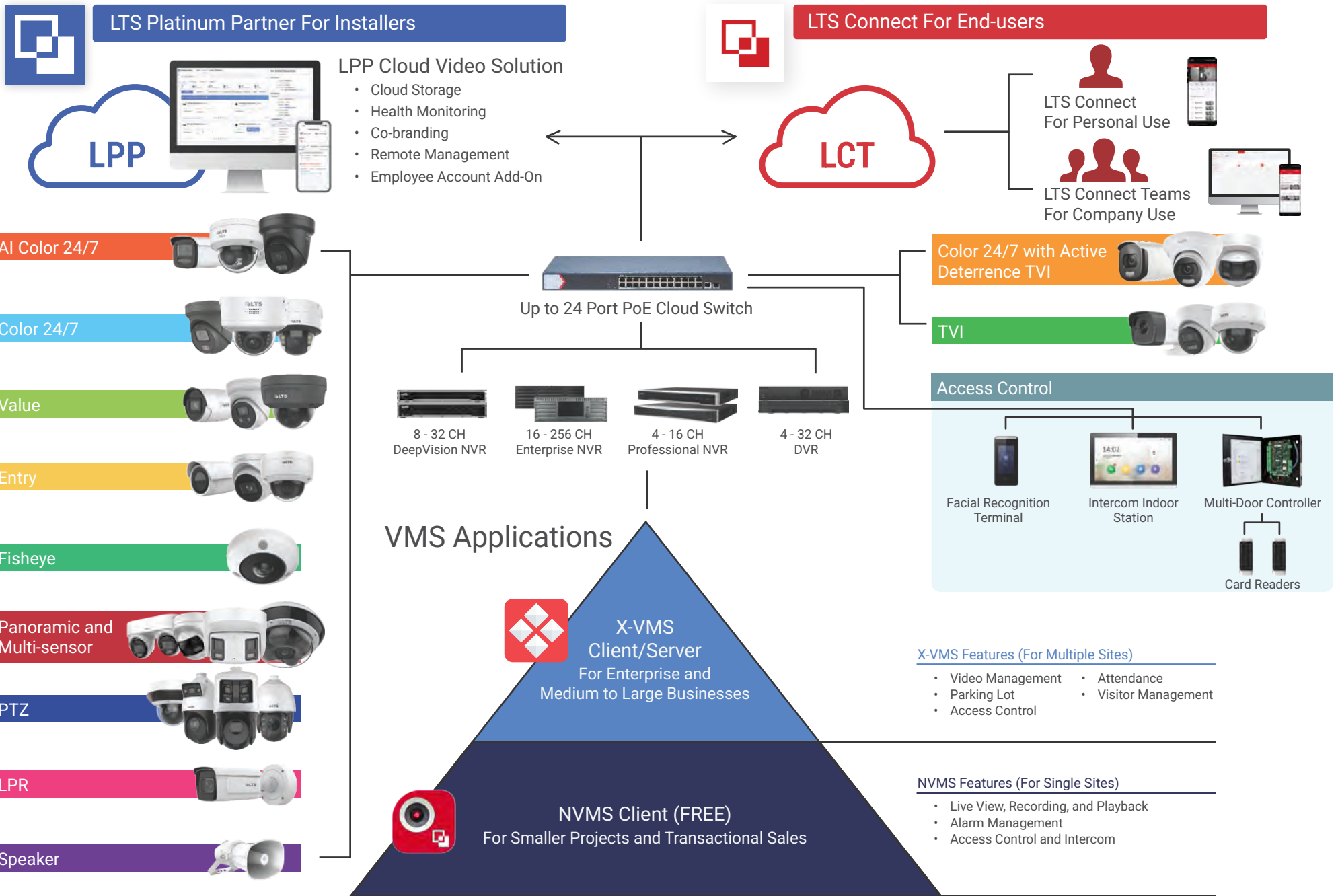

One Software Application for Total Control

X-VMS Architecture

X-VMS Features (For Multiple Sites)

- Video Management
- Parking Lot
- Access Control
- Attendance
- Visitor Management

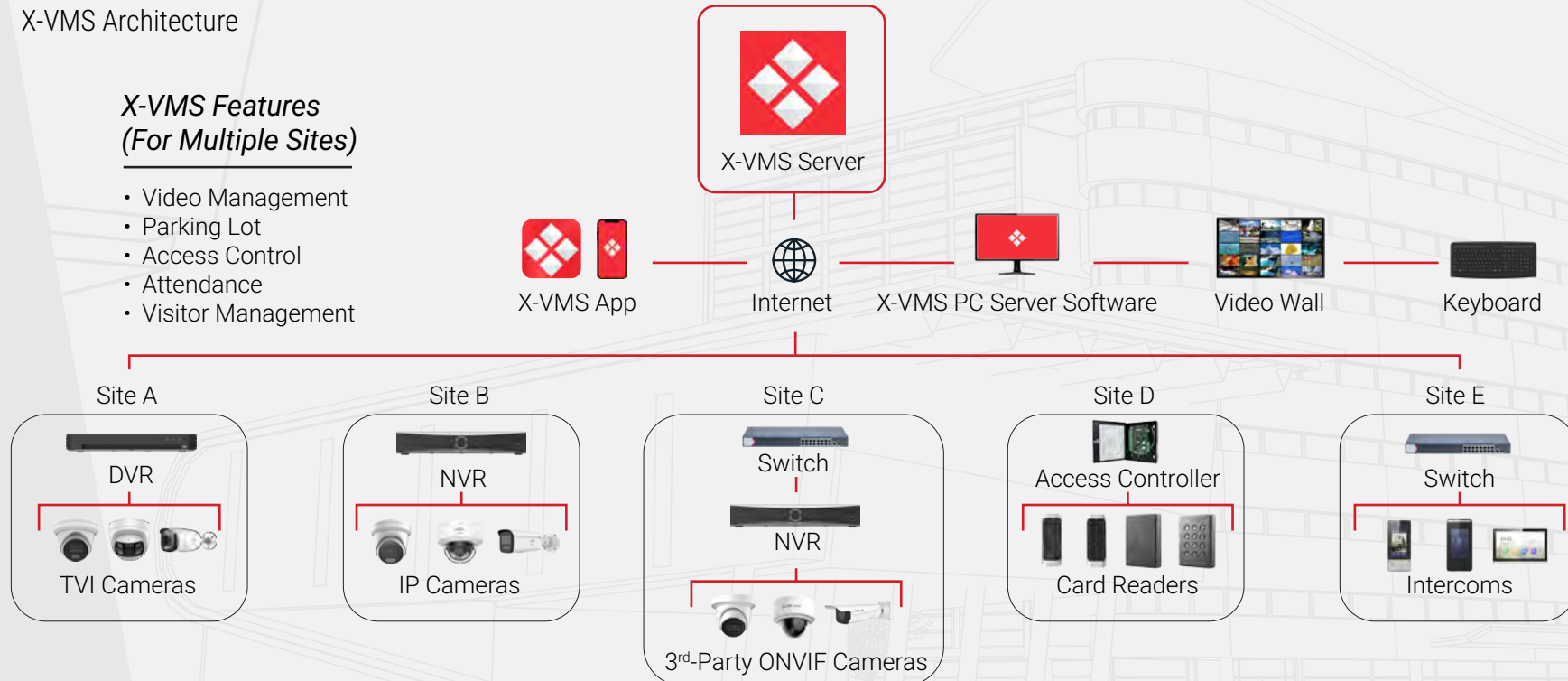

Semantic Search Capabilities



Our access control system integrates with our DeepVision NVRs for Semantic Search, enabling faster and smarter investigation

Mobile & Web Access Anywhere



Configure, monitor, and respond on the go. Whether on smartphone, tablet, or browser, you stay in control.

Always-On Health Monitoring

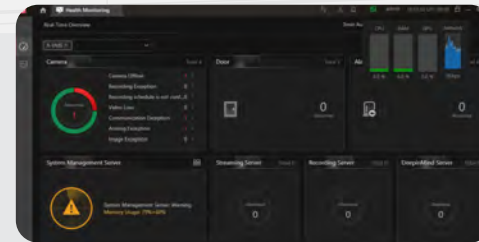

Stay in control with real-time and historical system health insights. Our intuitive dashboards make it easy to track device performance, pinpoint issues from the last 30 days, and ensure nothing goes unnoticed.

Dynamic Viewing Modes

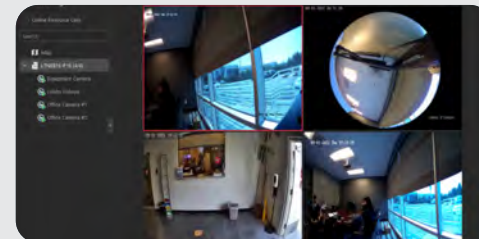

Designed for operational precision, our access control software supports versatile viewing modes such as live, panoramic, and grid layouts, enabling efficient surveillance management across diverse environments.

LTS Platinum Partner (LPP) - For Installers

Management Solution that Boosts Marketing, Lowers Labor Costs, and Creates Recurring Revenue

LTS Platinum Partner



Download App

LPP Basic FREE Feature: Remote Management



LTS Platinum Partner For Installers

LPP allows installers to create sites and share permissions to other installers and end-users



Installers create site

LTS Platinum Partner offers integrated marketing, revenue generation, and recurring income to streamline your business success. Read more below about how these premium paid add-ons can help you grow your business.

LPP Premium Features: Paid Add-ons

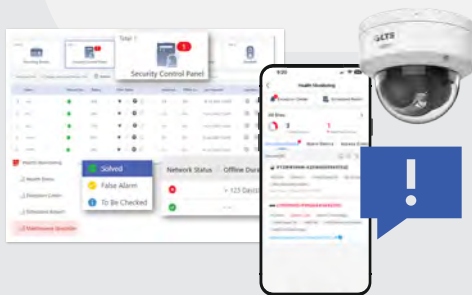

Health Monitoring

Installers can monitor device status and provide remote health management, including:

- Regular inspections for devices, HDDs, and network failures
- Prompt notifications and logs

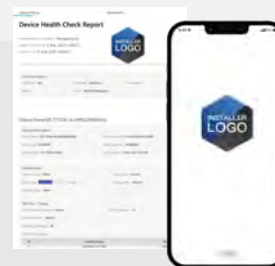

Co-Branding

- Expand your company's reach with enhanced brand recognition.
- LTS promotes your business by showcasing your logo on the app, NVR interface, and reports, effectively engaging both existing and potential customers.



Employee Account Add-On

- Installers can add users to both new and existing CCTV systems, making it easy for employees to collaborate.
- Employees can be assigned different permission levels based on their roles and responsibilities.

Find Moments in Seconds with Semantic Search

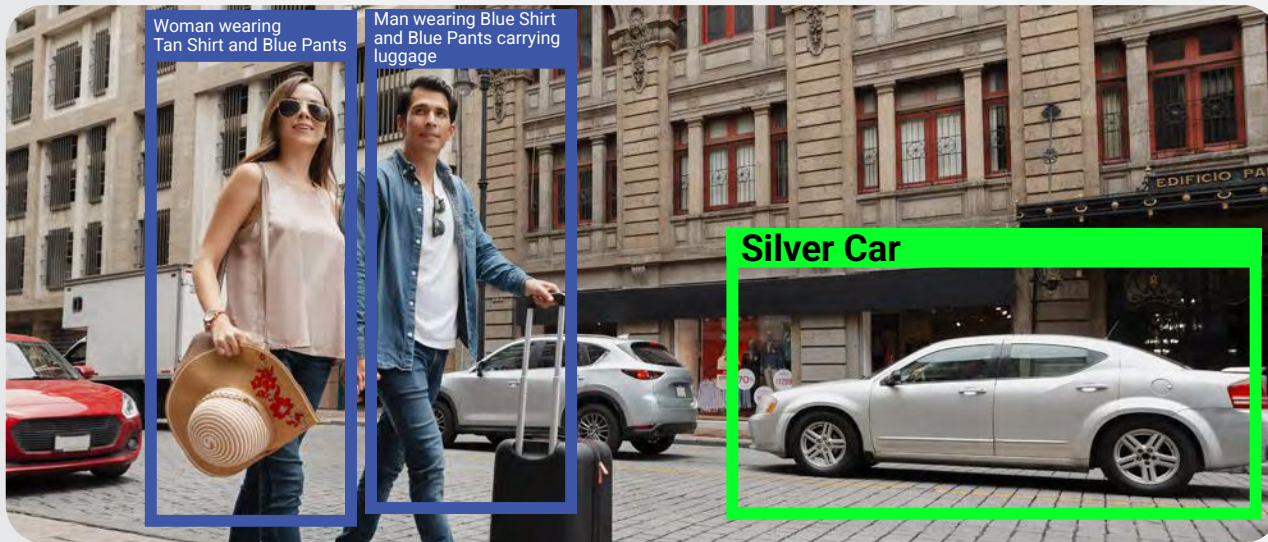

DeepVision NVRs deliver intelligent performance, seamless integration, and unmatched search efficiency. Designed for professionals who demand speed, accuracy, and reliability in every frame.

First Semantic Search NVR



As the first NVRs to integrate Semantic Search technology, DeepVision sets a new benchmark in intelligent video analytics and operational efficiency.

Intuitive Experience



Eliminate the need to manually review hours of footage. With Semantic Search, you can find subjects in seconds — simply enter a few descriptive keywords and let the system do the work.

Large Multimodal Model







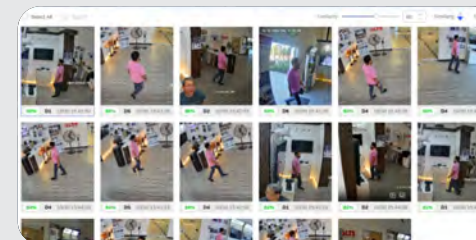







Powered by a large multimodal model, images and text are mapped into a shared vector space for seamless interaction. This enables advanced capabilities such as descriptive text-based searches to find the exact moment you're looking for.

Accurate Results



Semantic Search intelligently interprets your keywords to deliver the most relevant results. Adjust the similarity score to refine your search — higher scores return closely matched footage, while lower scores broaden the range of related results.

DeepVision NVR

SKU	LTN8608DV-P8	LTN8616DV-P16	LTN8932DV-P16
	  	  	  
Featuring	  	  	  
Video Input	8 Ch IP @ 96 Mbps	16 Ch IP @ 192 Mbps	32 Ch @ 384 Mbps
Video Output	HDMI up to 4K (3840 x 2160), VGA up to 1080p	HDMI up to 4K (3840 x 2160), VGA up to 1080p	HDMI1 up to 4K (3840 x 2160), HDMI2 up to 1080p, VGA up to 1080p
Max. Recording Resolution	up to 32 MP	up to 32 MP	up to 32 MP
Decoding Format	H.265+ / H.265 / H.264+ / H.264 / MPEG4	H.265+ / H.265 / H.264+ / H.264 / MPEG4	H.265+ / H.265 / H.264+ / H.264 / MPEG4
Decoding Capability	Enable AI by NVR: 20-ch @1080p (30 fps) Disable AI by NVR: 32-ch @1080p (30 fps)	Enable AI by NVR: 20-ch @1080p (30 fps) Disable AI by NVR: 32-ch @1080p (30 fps)	Enable AI by NVR: 20-ch @ 1080p (30 fps) Disable AI by NVR: 32-ch @ 1080p (30 fps)
Special Features	DeepVision, MD2.0, Facial Recognition, Direct-Search	DeepVision, MD2.0, Facial Recognition, Direct-Search	DeepVision, MD2.0, Facial Recognition, Direct-Search
Audio In / Out	IN: 1 line OUT: 1 line RCA	IN: 1 line OUT: 1 line RCA	IN: 1 line OUT: 1 line RCA
Alarm Channels (In / Out)	4/1	4/1	16/9
Built-in PoE	8 Ch	16 Ch	16 Ch
Bandwidth, Connector	10/100/1000 Mbps	10/100/1000 Mbps	10/100/1000 Mbps
Storage	2 x SATA up to 20TB each	2 x SATA up to 20TB each	4 x SATA up to 20TB each
POSS Supported	8 (TCP)	8 (TCP)	8 (TCP)
Hot Swap HDD	-	-	-
Backup	1 x USB 2.0, 1 x USB 3.0	1 x USB 2.0, 1 x USB 3.0	2 x USB 2.0, 1 x USB 3.0
Dimensions (W x D x H)	15.12" x 12.48" x 2.03"	15.12" x 12.48" x 2.03"	17.32" x 15.39" x 2.81"
Product QR Code			

*Please note Facial Recognition, Human / Vehicle Detection, and Direct-Search cannot be used simultaneously on compatible NVR and requires compatible AI Color 24/7 or Color 24/7 Cameras.

Instant Suspect Tracking at the Click of a Button



Direct-Search

With the new direct-search software, track targets accurately and quickly. The NVR reads the metadata pulled from the cameras and locates similar subjects within the search results, making it easy to find your subject of interest.

Track Your Suspects Easily



Say goodbye to manually digging through footage to find your perpetrator. Use Direct-Search to select a target in a given frame and expand the search through all the footage for similar subjects in minutes.

Vehicle Tracking

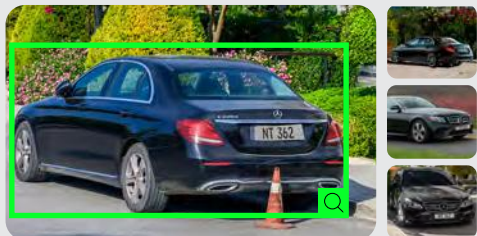

This software works with your camera system to help track vehicles entering your property.

Your Gatekeeper Against Unauthorized Access



Facial Recognition

The NVRs pull data from the AI Color 24/7 Cameras to alert you when unauthorized visitors are onsite. This technology is perfect for ensuring the safety of your home, property, and business.

Note: These two features cannot work simultaneously.

Screen Your Visitors



The facial recognition feature alerts you based on the database of allowed and blocked lists of individuals. For example, the system will notify you when VIPs on the permitted list enter the premises.

















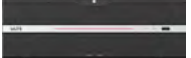











Enhanced Monitoring Across Every Channel





























The NVR leverages facial recognition technology across multiple channels to instantly alert you to security threats, such as individuals on a blocked list. This streamlined approach reduces costs by eliminating the need for real-time monitoring of each channel individually.

Note: Requires compatible camera models

Enterprise Level NVR

SKU	LTN8916D-N LTN8916D-P16N	LTN8932D-N LTN8932D-P16N	LTN8964-RN	LTN07128D-R16	LTN07256D-R16
	 	 	 	  	  
Featuring	 	 		  	  
Video Input	16 Ch IP @ 160 Mbps	32 Ch IP @ 256 Mbps	64 Ch IP @ 400 Mbps	128 CH @ 1280 Mbps	256 CH @ 1280 Mbps
Video Output	HDMI1 up to 4K (3840 x 2160) / VGA up to 1080p, HDMI2 up to 4K (3840 x 2160), CVBS up to 704 x 480	HDMI1 up to 4K (3840 x 2160), HDMI2 up to 4K (3840 x 2160), VGA up to 1080p, CVBS up to 704 x 480	HDMI1 up to 8K (7680 x 4320) / VGA1 up to 1080p, HDMI2 up to 4K (3840 x 2160) / VGA2 up to 1080p, CVBS up to 704 x 480	Default Mode: HDMI 1 / VGA 1 / HDMI 2 / VGA 2 / HDMI 3 / HDMI 4 up to 1080p; There are two simultaneous and two independent output modes available in total.	Default Mode: HDMI 1 / VGA 1 / HDMI 2 / VGA 2 / HDMI 3 / HDMI 4 up to 1080p There are two simultaneous and two independent output modes available in total.
Max. Recording Resolution	Up to 32 MP	Up to 32 MP	Up to 32 MP	Up to 32 MP	up to 32 MP
Decoding Format	H.265+/H.265/H.264+/H.264	H.265+/H.265/H.264+/H.264	H.265+/H.265/H.264+/H.264	H.265+/H.265/H.264+/H.264	H.265+/H.265/H.264+/H.264
Decoding Capability	VCA by NVR on: 10 Ch @ 4MP VCA by NVR off: 15 Ch @ 4MP	VCA by NVR on: 20 Ch @ 1080p VCA by NVR off: 30 Ch @ 1080p	8 Ch @ 8 MP / 16 Ch @ 4 MP	2-ch @ 32 MP (30 fps) / 2-ch @ 24 MP (30fps) / 4-ch @ 16 MP (30fps) / 8-ch @ 8 MP (30fps) / 16-ch @ 4 MP (30fps) / 32-ch @ 2 MP (30fps)	2-ch@32 MP (30 fps)/2-ch@24 MP (30fps)/4-ch@16 MP (30fps)/8-ch@8 MP (30fps)/16-ch@4 MP (30fps)/32-ch@2 MP (30fps)
Special Features	Direct-Search, Facial Recognition	Direct-Search, Facial Recognition	RAID	MD2.0, Direct-Search, Facial Recognition	MD2.0, Facial Recognition, Direct-Search
Audio In / Out	IN: 1 line OUT: 1 line RCA	IN: 1 line OUT: 1 line RCA	IN: 1 line OUT: 2 lines RCA	2-ch RCA	2-ch RCA
Alarm Channels (In / Out)	16/9	16/9	16/9	32/16	32/16
Built-in PoE	-/16Ch	-/16 Ch	-	-	-
Bandwidth, Connector	10/100/1000 Mbps, 2 x RJ45	10/100/1000 Mbps, 2 x RJ45	10/100/1000 Mbps, 2 x RJ45	10/100/1000/2500 Mbps	10/100/1000/2500 Mbps
Storage	4 x SATA up to 16 TB each, eSATA, NAS, IP SAN	4 x SATA up to 16 TB each, eSATA, NAS, IP SAN	8 x SATA up to 16 TB each, eSATA, NAS, IP SAN, RAID 0 / 1 / 5 / 6 / 10	16 x SATA up to 20 TB each	16 x SATA up to 20 TB each
POs Supported	8 (TCP or RS232)	8 (TCP or RS232)	8 (TCP or RS232)	-	-
Hot Swap HDD	-	-	Yes	-	-
Backup	2 x USB 2.0, 1 x USB 3.0, eSATA	2 x USB 2.0, 1 x USB 3.0, eSATA	2 x USB 2.0, 2 x USB 3.0, eSATA	2 x USB 2.0, 4 x USB 3.0	2 x USB 2.0, 4 x USB 3.0
Dimensions (W x D x H)	17.3" x 15.4" x 3.0"	17.3" x 15.4" x 3.0"	17.5" x 18.3" x 3.6"	17.4" x 19.5" x 5.7"	17.4" x 19.5" x 5.7"
Product QR Code	 	 			

*Please note Facial Recognition, Human / Vehicle Detection, and Direct-Search cannot be used simultaneously on compatible NVR and requires compatible AI Color 24/7 or Color 24/7 Cameras.

Professional Level NVR						
SKU	LTN8704QN-P4	LTN8708QN-P8	LTN8708D-P8N	LTN8716D-P16N	LTN8608D-P8N	LTN8616D-P16N
	 	 	 	 	 	 
Featuring			 	 	 	 
Video Input	4 Ch IP @ 40 Mbps	8 Ch IP @ 80 Mbps	8 Ch IP @ 80 Mbps	16 Ch IP @ 160 Mbps	8 Ch IP @ 80 Mbps	16 Ch IP @ 160 Mbps
Video Output	HDMI up to 4K (3840 x 2160) / VGA up to 1080p	HDMI up to 4K (3840 x 2160) / VGA up to 1080p	HDMI up to 4K (3840 x 2160), VGA up to 1080p	HDMI up to 4K (3840 x 2160), VGA up to 1080p	HDMI up to 4K (3840 x 2160), VGA up to 1080p, CVBS up to 704 x 480	HDMI up to 4K (3840 x 2160), VGA up to 1080p, CVBS up to 704 x 480
Max. Recording Resolution	Up to 4K, 8 MP (3840 x 2160)	Up to 4K, 8 MP (3840 x 2160)	Up to 12 MP	Up to 12 MP	Up to 32 MP	Up to 32 MP
Decoding Format	H.265+/H.265/H.264+/H.264	H.265+/H.265/H.264+/H.264	H.265+/H.265/H.264+/H.264	H.265+/H.265/H.264+/H.264	H.265+/H.265/H.264+/H.264	H.265+/H.265/H.264+/H.264
Decoding Capability	1 Ch @ 8 MP / 2 Ch @ 4 MP	1 Ch @ 8 MP / 2 Ch @ 4 MP	VCA by NVR on: 4 Ch @ 4 MP VCA by NVR off: 6 Ch @ 4 MP	VCA by NVR on: 4 Ch @ 4 MP VCA by NVR off: 6 Ch @ 4 MP	VCA by NVR on: 5 Ch @ 8MP VCA by NVR off: 7 Ch @ 8MP	VCA by NVR on: 20 Ch @ 1080p VCA by NVR off: 30 Ch @ 1080p
Special Features	-	-	Facial Recognition, Direct-Search	Facial Recognition, Direct-Search	Facial Recognition, Direct-Search	Facial Recognition, Direct-Search
Audio In / Out	IN: 1 line OUT: 1 line RCA	IN: 1 line OUT: 1 line RCA	IN: 1 line OUT: 1 line RCA	IN: 1 line OUT: 1 line RCA	IN: 1 line OUT: 1 line RCA	IN: 1 line OUT: 1 line RCA
Alarm Channels (In / Out)	-	-	4/1	4/1	4/1	4/1
Built-in PoE	4 Ch	8 Ch	8 Ch	16 Ch	8 Ch	16 Ch
Bandwidth, Connector	10/100/1000 Mbps, 1 x RJ45	10/100/1000 Mbps, 1 x RJ45	10/100/1000 Mbps, 1 x RJ45	10/100/1000 Mbps, 1 x RJ45	10/100/1000 Mbps, 1 x RJ45	10/100/1000 Mbps, 1 x RJ45
Storage	1 x SATA up to 8 TB, NAS, IP SAN	2 x SATA up to 8 TB, NAS, IP SAN	2 x SATA up to 10 TB each, NAS, IP SAN	2 x SATA up to 10 TB each, NAS, IP SAN	2 x SATA up to 16 TB each, NAS, IP SAN	2 x SATA up to 16 TB each, NAS, IP SAN
POSs Supported	-	-	-	-	4 (TCP)	4 (TCP)
Backup	2 x USB 2.0	2 x USB 2.0	1 x USB 2.0, 1 x USB 3.0	1 x USB 2.0, 1 x USB 3.0	1 x USB 2.0, 1 x USB 3.0	1 x USB 2.0, 1 x USB 3.0
Dimensions (W x D x H)	12.4" x 9.4" x 1.9"	15.2" x 12.4" x 2.0"	15.2" x 12.4" x 2.0"	15.2" x 12.4" x 2.0"	15.2" x 12.5" x 2.0"	15.2" x 12.5" x 2.0"
Product QR Code						

*Please note Facial Recognition, Human / Vehicle Detection, and Direct-Search cannot be used simultaneously on compatible NVR and requires compatible AI Color 24/7 or Color 24/7 Cameras.

Control Without Compromise

NVMS V3 (FREE)

NVMS Architecture Application

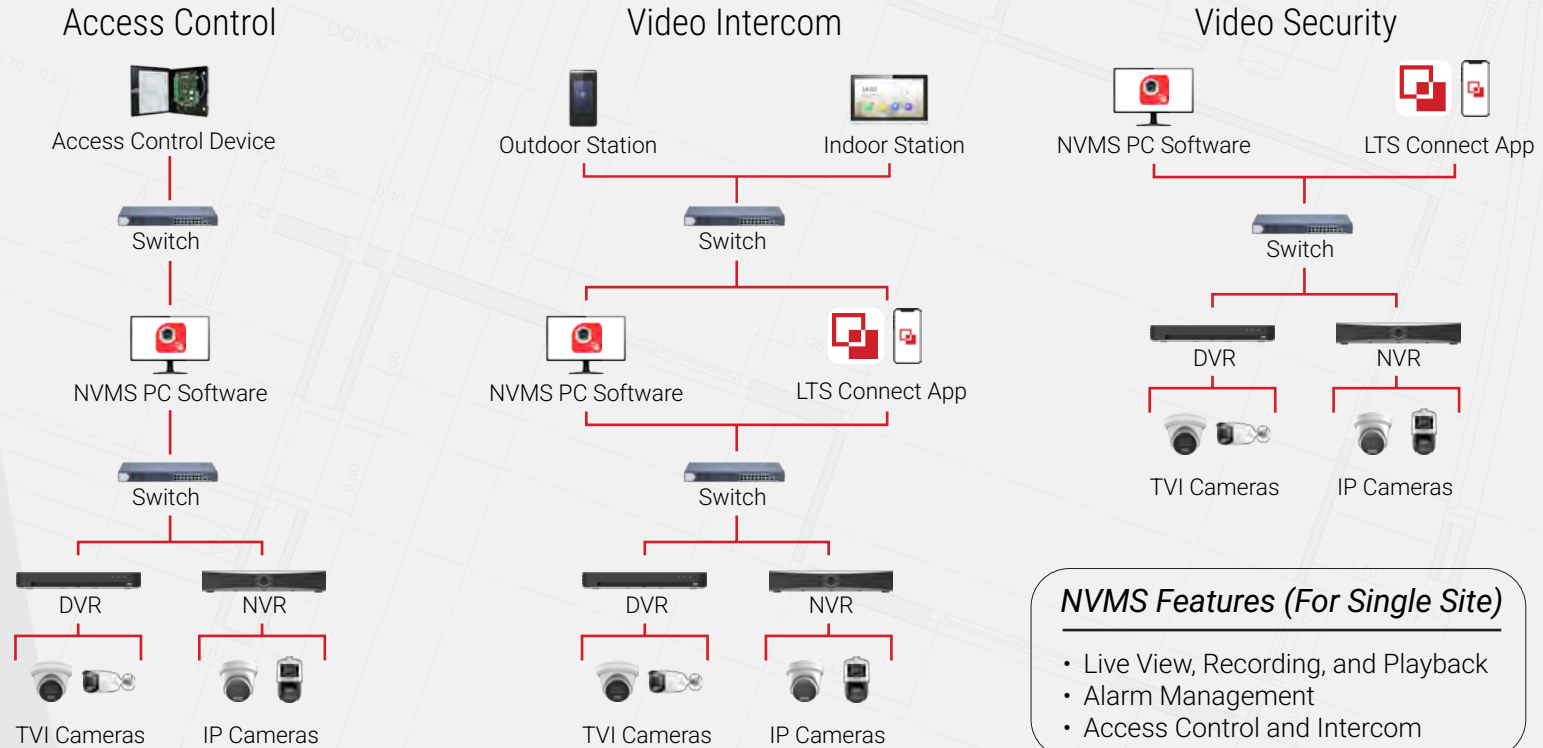

- NVMS Features (For Single Site)**
- Live View, Recording, and Playback
 - Alarm Management
 - Access Control and Intercom

Experience Pro Control for Free



Enjoy intelligent video search, smooth navigation, and seamless access management. All without the price tag.

Designed for Ease



NVMS is an intuitive software that puts full control at your fingertips with a clean design and simple navigation.

Built for Single-Site Control



Designed for single-site security, our software keeps everything simple, fast, and reliable.

10X Better Color 24/7 Performance to Seal the Deal



LT Security proudly presents AI Color 24/7 cameras, which feature enhanced algorithms and features for outstanding visual performance. Prepare to improve your experience with high-quality images in low light, anti-corrosion housing, AI WDR, higher accuracy rate, enhanced audio, direct-search, and more.

Advanced AI-ISP Enhances Color Image Quality in Low-Light Conditions

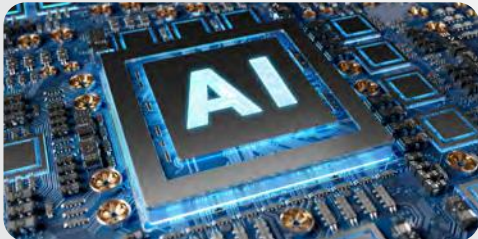

The built-in AI chip brightens images, reduces noise, enhances color accuracy, and provides more detailed clarity. Additionally, this new technology supports color correction and matching. AI WDR improves clarity and detail in environments with high-contrast lighting.

Active Deterrence



The AI Color 24/7 cameras ending in -LAISP feature red and blue strobe lights, along with two-way audio, making them effective for deterring intruders.

Anti-corrosion NEMA 4X Housing for Harsh Conditions





















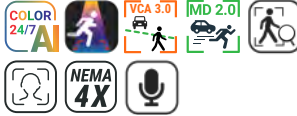
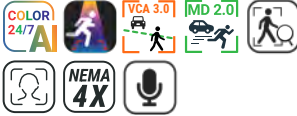

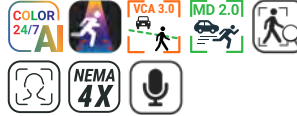
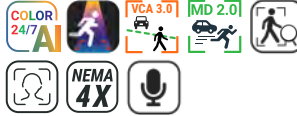



The anti-corrosion NEMA 4X housing can withstand harsh environmental conditions, ensuring reliable yearly performance.





















VCA 3.0 for Enhanced Accuracy































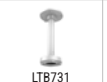





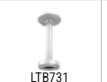

Minimize false alarms with our advanced human and vehicle detection algorithm. Combined with line crossing detection, our cameras help identify and alert you to unauthorized movements across defined boundaries.

AI Color 24/7 Cameras						
SKU	CMIP3CD42WI-28AISP	CMIP3CD42WIB-28AISP	CMIP3CD42WI-AISP	CMIP3CD82WIB-28AISP	CMIP3CD82WI-AISP	
						
						
						
Max. Resolution	4MP, 2688 x 1520 @ 30 fps	4MP, 2688 x 1520 @ 30 fps	4MP, 2688 x 1520 @ 30 fps	8MP, 3840 x 2160 @ 30 fps	8MP, 3840 x 2160 @ 30 fps	
Lens	2.8mm, Fixed	2.8mm, Fixed	4mm, Fixed	2.8mm, Fixed	4mm, Fixed	
Min. Illumination	0.0001 Lux @ F1.0, AGC ON, 0 Lux with suppl. Light	0.0001 Lux @ F1.0, AGC ON, 0 Lux with suppl. Light	0.0001 Lux @ F1.0, AGC ON, 0 Lux with suppl. Light	0.0005 Lux @ F1.0, AGC ON, 0 Lux with suppl. Light	0.0005 Lux @ F1.0, AGC ON, 0 Lux with suppl. Light	
Image Sensor	1/1.8" Progressive Scan CMOS	1/1.8" Progressive Scan CMOS	1/1.8" Progressive Scan CMOS	1/1.8" Progressive Scan CMOS	1/1.8" Progressive Scan CMOS	
Special Features	AI Color 24/7, Hybrid Illumination, VCA 3.0, Human/Vehicle Detection, Auto WDR 130dB, Direct-Search, Face Capture	AI Color 24/7, Hybrid Illumination, VCA 3.0, Human/Vehicle Detection, Auto WDR 130dB, Direct-Search, Face Capture	AI Color 24/7, Hybrid Illumination, VCA 3.0, Human/Vehicle Detection, Auto WDR 130dB, Direct-Search, Face Capture	AI Color 24/7, Hybrid Illumination, VCA 3.0, Human/Vehicle Detection, Auto WDR 130dB, Direct-Search, Face Capture	AI Color 24/7, Hybrid Illumination, VCA 3.0, Human/Vehicle Detection, Auto WDR 130dB, Direct-Search, Face Capture	
Audio In / Out	Built-in Mic	Built-in Mic	Built-in Mic	Built-in Mic	Built-in Mic	
Alarm In / Out	-	-	-	-	-	
MicroSD Storage	Up to 512 GB	Up to 512 GB	Up to 512 GB	Up to 512 GB	Up to 512 GB	
Protection	IP67, NEMA 4X	IP67, NEMA 4X	IP67, NEMA 4X	IP67, NEMA 4X	IP67, NEMA 4X	
Power	12V DC, PoE	12V DC, PoE	12V DC, PoE	12V DC, PoE	12V DC, PoE	
Product QR Code						
	Compatible with All Cameras Above					
Compatible Accessories	 LTB701 LTB701BK Junction Box (White/Black)	 LTB342-JBOX Junction Box for LTB342-140	 LTB342-140 Wall Mount	 LTB341 Pendant Mount 22" (56cm)	 LTB378 Pole Mount	 LTB379 Corner Mount

*Direct-Search and Facial Recognition features are only available with compatible NVR (-D) models.















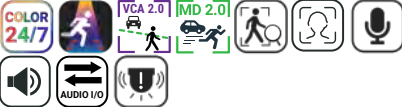

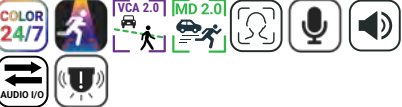

















AI Color 24/7 Cameras		AI Color 24/7 - Active Deterrence				
SKU	CMIP3CD82WI-28AISP	CMIP3CD42WI-28LAISP	CMIP3CD82WI-28LAISP			
	  	 	  			
Featuring						
Max. Resolution	8MP, 3840 x 2160 @ 30 fps	4MP, 2688 x 1520 @ 30 fps	8MP, 3840 x 2160 @ 30 fps			
Lens	2.8mm, Fixed	2.8mm, Fixed	2.8mm, Fixed			
Min. Illumination	0.0005 Lux @ F1.0, AGC ON, 0 Lux with suppl. Light	0.0001 Lux @ F1.0, AGC ON, 0 Lux with suppl. Light	0.0005 Lux @ F1.0, AGC ON, 0 Lux with suppl. Light			
Image Sensor	1/1.8" Progressive Scan CMOS	1/1.8" Progressive Scan CMOS	1/1.8" Progressive Scan CMOS			
Special Features	AI Color 24/7, Hybrid Illumination, VCA 3.0, Human/Vehicle Detection, Auto WDR 130dB, Direct-Search, Face Capture	AI Color 24/7, Hybrid Illumination, Active Deterrence with Red & Blue Strobe Lights, VCA 3.0, Human/Vehicle Detection, Auto WDR 130dB, Direct-Search, Face Capture	AI Color 24/7, Hybrid Illumination, Active Deterrence with Red & Blue Strobe Lights, VCA 3.0, Human/Vehicle Detection, Auto WDR 130dB, Direct-Search, Face Capture			
Audio In / Out	Built-in Mic	IN: 1 line OUT: 1 line Built-in Mic & Speaker	IN: 1 line OUT: 1 line Built-in Mic & Speaker			
Alarm In / Out	-	1/1	1/1			
MicroSD Storage	Up to 512 GB	Up to 512 GB	Up to 512 GB			
Protection	IP67, NEMA 4X	IP67, NEMA 4X	IP67, NEMA 4X			
Power	12V DC, PoE	12V DC, PoE	12V DC, PoE			
Product QR Code						
Compatible with All Cameras Above						
Compatible Accessories	 LTB701 LTB701BK Junction Box (White/Black)	 LTB342-JBOX Junction Box for LTB342-140	 LTB342-140 Wall Mount	 LTB341 Pendant Mount 22" (56cm)	 LTB378 Pole Mount	 LTB379 Corner Mount

*Direct-Search and Facial Recognition features are only available with compatible NVR (-D) models.





















AI Color 24/7 Cameras					
SKU	CMIP7CD42WI-28AISP	CMIP7CD82WI-28AISP	CMIP8CD42WI-28AISP	CMIP9CD42WI-28AISP	CMIP9CD82WI-28AISP
					
Featuring					
Max. Resolution	4MP, 2688 x 1520 @ 30 fps	8MP, 3840 x 2160 @ 30 fps	4MP, 2688 x 1520 @ 30 fps	4MP, 2688 x 1520 @ 30 fps	8MP, 3840 x 2160 @ 30 fps
Lens	2.8mm, Fixed	2.8mm, Fixed	2.8mm, Fixed	2.8mm, Fixed	2.8mm, Fixed
Min. Illumination	0.0001 Lux @ F1.0, AGC ON, 0 Lux with suppl. Light	0.0005 Lux @ F1.0, AGC ON, 0 Lux with suppl. Light	0.0001 Lux @ F1.0, AGC ON, 0 Lux with suppl. Light	0.0001 Lux @ F1.0, AGC ON, 0 Lux with suppl. Light	0.0005 Lux @ F1.0, AGC ON, 0 Lux with suppl. Light
Image Sensor	1/1.8" Progressive Scan CMOS	1/1.8" Progressive Scan CMOS	1/1.8" Progressive Scan CMOS	1/1.8" Progressive Scan CMOS	1/1.8" Progressive Scan CMOS
Special Features	AI Color 24/7, Hybrid Illumination, VCA 3.0, Human/Vehicle Detection, Auto WDR 130dB, Direct-Search, Face Capture	AI Color 24/7, Hybrid Illumination, VCA 3.0, Human/Vehicle Detection, Auto WDR 130dB, Direct-Search, Face Capture	AI Color 24/7, Hybrid Illumination, VCA 3.0, Human/Vehicle Detection, Auto WDR 130dB, Direct-Search, Face Capture	AI Color 24/7, Hybrid Illumination, VCA 3.0, Human/Vehicle Detection, Auto WDR 130dB, Direct-Search, Face Capture	AI Color 24/7, Hybrid Illumination, VCA 3.0, Human/Vehicle Detection, Auto WDR 130dB, Direct-Search, Face Capture
Audio In / Out	IN: 1 line OUT: 1 line Built-in Mic	IN: 1 line OUT: 1 line Built-in Mic	Built-in Mic	-	-
Alarm In / Out	1/1	1/1	-	-	-
MicroSD Storage	Up to 512 GB	Up to 512 GB	Up to 512 GB	Up to 512 GB	Up to 512 GB
Protection	IP67, IK10, NEMA 4X	IP67, IK10, NEMA 4X	IP67, NEMA 4X	IP67, NEMA 4X	IP67, NEMA 4X
Power	12V DC, PoE	12V DC, PoE	12V DC, PoE	12V DC, PoE	12V DC, PoE
Product QR Code					
Compatible Accessories	 LTB347H Junction Box  LTB742-120B Wall Mount with Junction Box  LTB742-120 Wall Mount  LTB731 Pendant Mount  LTB378 Pole Mount  LTB379 Corner Mount	 LTB347H Junction Box  LTB742-120B Wall Mount with Junction Box  LTB742-120 Wall Mount  LTB731 Pendant Mount  LTB378 Pole Mount  LTB379 Corner Mount	 LTB345 Junction Box  LTB378 Pole Mount  LTB379 Corner Mount  LTB801 Junction Box  LTB378 Pole Mount  LTB379 Corner Mount	 LTB801 Junction Box  LTB378 Pole Mount  LTB379 Corner Mount	

*Direct-Search and Facial Recognition features are only available with compatible NVR (-D) models.

Color 24/7 IP Turret Cameras

SKU	CMIP3C42WI-28MDA	CMIP3C42WI-28SDL	CMIP3C82WI-28MDA	CMIP3C82WI-28SDL								
												
Featuring												
Max. Resolution	4 MP, 2688 x 1520 @ 30 fps	4 MP, 2688 x 1520 @ 30 fps	8 MP, 3840 x 2160 @ 24 fps	8 MP, 3840 x 2160 @ 24 fps								
Lens	2.8 / 4 mm, Fixed	2.8 mm, Fixed	2.8 mm, Fixed	2.8 mm, Fixed								
Min. Illumination	0.001 Lux @ F 1.0, AGC ON, 0 Lux with light	0.001 Lux @ F 1.0, AGC ON, 0 Lux with light	0.0008 Lux @ F1.0, AGC ON, 0 Lux with suppl. light	0.0008 Lux @ F1.0, AGC ON, 0 Lux with suppl. light								
Image Sensor	1/3" Progressive Scan CMOS	1/3" Progressive Scan CMOS	1/1.8" Progressive Scan CMOS	1/1.8" Progressive Scan CMOS								
Special Features	Color 24/7, Hybrid Illumination, VCA 2.0, Human/Vehicle Detection, WDR 120 dB, Direct-Search, Face Capture	Color 24/7, Hybrid Illumination, VCA 2.0, Active Deterrence with Red & Blue Strobe Light, Human/Vehicle Detection, WDR 130 dB, Face Capture	Color 24/7, Hybrid Illumination, VCA 2.0, Human/Vehicle Detection, WDR 130dB, Direct-Search, Face Capture	Color 24/7, Hybrid Illumination, VCA 2.0, Active Deterrence with Red & Blue Strobe Light, Human/Vehicle Detection, WDR 130 dB, Face Capture								
Audio In / Out	Built-in Mic	IN: 1 line OUT: 1 line Built-in Mic & Speaker	Built-in Mic	IN: 1 line OUT: 1 line Built-in Mic & Speaker								
Alarm In / Out	-	1/1	-	1/1								
MicroSD Storage	Up to 512 GB	Up to 512 GB	Up to 512 GB	Up to 512 GB								
Protection	IP67	IP67	IP67	IP67								
Power	12V DC, PoE	12V DC, PoE	12V DC, PoE	12V DC, PoE								
Product QR Code												
Compatible Accessories												
												

*Direct-Search and Facial Recognition features are only available with compatible NVR (-D) models.

Color 24/7 IP Dome Cameras							
SKU	CMIP7C42WI-28MDA			CMIP7C82WI-28MDA			
	 						
Featuring							
Max. Resolution	4 MP, 2688 x 1520 @ 30 fps			8 MP, 3840 x 2160 @ 24 fps			
Lens	2.8 mm, Fixed			2.8 mm, Fixed			
Min. Illumination	0.001 Lux @ F1.0, AGC ON, 0 Lux with light			0.0008 Lux @ F 1.0, AGC ON, 0 Lux with light			
Image Sensor	1/3" Progressive Scan CMOS			1/1.8" Progressive Scan CMOS			
Special Features	Color 24/7, Hybrid Illumination, VCA 2.0, Human/Vehicle Detection, WDR 120 dB, Direct-Search, Face Capture			Color 24/7, Hybrid Illumination, VCA 2.0, Human/Vehicle Detection, WDR 130 dB, Direct-Search, Face Capture			
Audio In / Out	IN: 1 line OUT: 1 line Built-in Mic			IN: 1 line OUT: 1 line Built-in Mic			
Alarm In / Out	1/1			1/1			
MicroSD Storage	Up to 512 GB			Up to 512 GB			
Protection	IP67, IK10			IP67, IK10			
Power	12V DC, PoE			12V DC, PoE			
Product QR Code							
Compatible Accessories	 LTB347H Junction Box	 LTB742-120 Wall Mount	 LTB742-120B Wall Mount with Junction Box	 LTB347H Junction Box	 LTB742-120 Wall Mount	 LTB742-120B Wall Mount with Junction Box	
	 LTB731 Pendant Mount	 LTB378 Pole Mount	 LTB379 Corner Mount	 LTB731 Pendant Mount	 LTB378 Pole Mount	 LTB379 Corner Mount	

*Direct-Search and Facial Recognition features are only available with compatible NVR (-D) models.

Maximize Your Time with Faster, Easier Installation

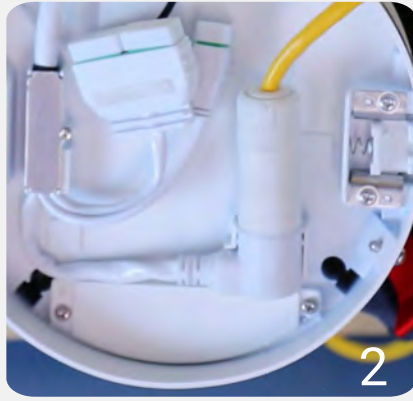

The era of lengthy installation with traditional cameras is over. InstaDome reduces installation time by 5X thanks to its removable plate, cable management, and remotely adjustable lens. It also provides key features such as active deterrence and human and vehicle detection.

Remotely Adjust Lens

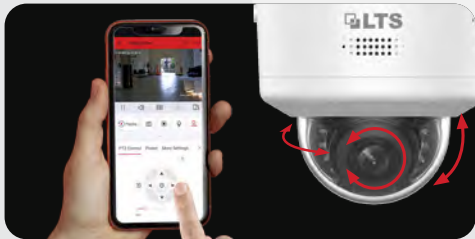

Rather than removing the camera to adjust wires and cameras by hand, you can remotely adjust the lens for pan, tilt, zoom, and z-axis via the app.

Active Deterrence



The InstaDome triggers a white strobe light to warn intruders once they enter the detection zone. You can also use the two-way audio feature to discourage unwanted visitors from trespassing.

Organized Cable Management















The InstaDome has a removable plate that comes off, revealing neatly arranged cables within the junction box, significantly reducing installation times by 80%.

VCA 2.0 Human & Vehicle Detection for Reduced False Alarms





With VCA 2.0, false alarms are significantly reduced by accurately distinguishing humans and vehicles from non-relevant objects, alerting you to genuine security threats.











Color 24/7 InstaDome	
SKU	CMIP7C43WI-SDLQ
	
Featuring	
Max. Resolution	4 MP, 2688 x 1520 @ 30 fps
Lens	2.8 - 12 mm, VF, Motorized
Min. Illumination	0.0028 Lux @ F1.2, AGC on, 0 Lux with Light on
Image Sensor	1/1.8" Progressive Scan CMOS
Special Features	Color 24/7, Hybrid Illumination, VCA 2.0, Active Deterrence with White Strobe Light, Human/Vehicle Detection, WDR 120 dB, Face Capture, InstaDome
Audio In / Out	IN: 1 line OUT: 1 line 2 Built-in Mics, 1 Built-in Speaker
Alarm In / Out	1/1
MicroSD Storage	Up to 512 GB
Protection	IP66, IK10
Power	12V DC, PoE
Product QR Code	
Compatible Accessories	<div style="display: flex; justify-content: space-around;"> <div style="text-align: center;"> LTB342-155 Wall Mount</div> <div style="text-align: center;"> LTB342-JBOX Junction Box for Wall Mount</div> <div style="text-align: center;"> LTB378 Pole Mount</div> <div style="text-align: center;"> LTB379 Corner Mount</div> </div>

License Plate IP Camera	
SKU	CMIP7943WLPR-32R
	 Junction Box Included
Featuring	
Max. Resolution	4 MP, 2688 x 1520 @ 30 fps
Lens	8 - 32 mm, Motorized
Min. Illumination	0.0005 Lux @ F1.2, 0 Lux with IR
Supplemental Lighting	Matrix IR up to 328 ft
Special Features	License Plate Recognition, VCA 2.0, Human/Vehicle Detection, WDR 140 dB
License Plate Recognition	Capture Rate > 98%, Recognition Rate > 96%, Searchable from IP Camera & NVR
MicroSD Storage	Up to 256 GB
Audio In / Out	-
Alarm In / Out	2/2
Protection	IP67, IK10
Product QR Code	
Compatible Accessories	<div style="display: flex; justify-content: space-around;"> <div style="text-align: center;"> LTB388 Pole Mount</div> <div style="text-align: center;"> LTB389 Corner Mount</div> </div>

*Direct-Search and Facial Recognition features are only available with compatible NVR (-D) models.

















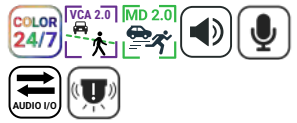
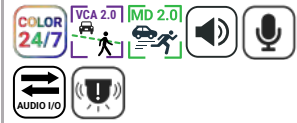
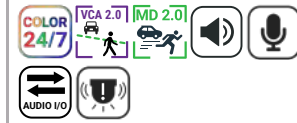









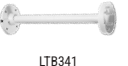





Platinum Speaker | Surveillance Box

IP Speaker	
SKU	LTA-NHS120-P
	
Featuring	
Max. Acoustic Pressure	121 dB SPL
Speaker Sensitivity	110 dB (1 m 1 W)
Frequency Response	300 Hz to 13 kHz
Microphones	2 x Electret, 100 Hz to 20 kHz
Audio Compression	G.711ulaw (64 Kbps) / G.711alaw (64 Kbps) / MP3 (128 Kbps)
Audio File Format	WAV, MP3, MP2, AAC
Alarm Channels (I/O)	1/1
Ethernet	0/100 Mbps, 1 x RJ45
Storage	64 GB EMMC
Protection Ratings	IP67
Power	12V DC, PoE power passthrough, < 10 W
Product QR Code	

Outdoor Surveillance Box	
SKU	OutdoorBox-03
	 Installation Plate Included
Featuring	
Material	PC/ASA; LTS White (RAL 9003)
Dimension	448.72mm x 387.53mm x 225.44mm
Weight	5.2kg
Startup and Operating Conditions	-40 °C to 60 °C (-40 °F to 140 °F). Humidity 95% or less (non-condensing)
Add-Ons	Supports up to three cameras and an IP speaker
General Function	Loading Capacity of Front Panel is 8kg; side panel is 5kg
Power	12V DC, PoE power passthrough, < 10 W
Protection	IP66, IK10
Product QR Code	
Compatible Accessories	 LTB345 Junction Box  LTB801 Junction Box  LTB701 Junction Box
	 LTB347H Junction Box  LTB453 Junction Box  LTB03-W Junction Box  LTB762 Wall Mount

*IP Speaker requires pairing with a built-in mic camera and NVR. Compatible with NVR LTN87XXD with fw (v4.82+), and 86XXD/89XXD (v5.03+). iOS app (v6.8.3+), and Android app (v6.8.3+).

Panoramic IP Cameras

SKU	CMIP384PW-28SDL	CMIP398PW-2SDL	CMIP3C6PW-28SDL	CMIP3C8PW-SDL	CMIP9C8PW-SDL
		 NEW		 4K	 4K Junction Box Included
Featuring					
Max. Resolution	4MP, 3040 x 1368 @ 24 fps	8MP, 4256 x 1888 @ 20fps	6 MP, 3632 x 1632 @ 20 fps	8 MP, 5120 x 1440 @ 20 fps or 15 fps	8 MP, 5120 x 1440 @ 20 fps
Lens	2 x 2.8mm, 180° Horizontal, 81° Vertical	2 x 2mm, 180° Horizontal, 77° Vertical	2 x 2.8mm, 180° Horizontal, 81° Vertical	2 x 4mm, 180° Horizontal, 44° Vertical	2 x 4mm, 180° Horizontal, 44° Vertical
Min. Illumination	0.003 Lux @ F1.6, AGC ON, 0 Lux IR	Color: 0.005 Lux @ (F1.6, AGC ON), 0 Lux with light	0.0005 Lux @ F1.0, 0 Lux with suppl. light	0.0005 Lux @ F1.0, 0 Lux with LED Light on	0.0005 Lux @ F1.0, AGC ON, 0 Lux with suppl. light
Image Sensor	2 x 1/2.5" Progressive Scan CMOS	1/2.4" Progressive Scan CMOS	2 x 1/2.5" Progressive Scan CMOS	2 x 1/1.8" Progressive Scan CMOS	2 x 1/1.8" Progressive Scan CMOS
Special Features	Active Deterrence with White Strobe Light, VCA 2.0, Human/Vehicle Detection, WDR 120 dB	Hybrid Illumination, Active Deterrence with Blue & Red Strobe Light, Human/Vehicle Detection, WDR 120dB	Color 24/7, VCA 2.0, Active Deterrence with White Strobe Light, Human/Vehicle Detection, WDR 130 dB	Color 24/7, VCA 2.0, Active Deterrence with White Strobe Light, Human/Vehicle Detection, WDR 130 dB	Color 24/7, VCA 2.0, Active Deterrence with White Strobe Light, Human/Vehicle Detection, WDR 130 dB
Audio In / Out	IN: 1 line OUT: 1 line Built-in Mic & Speaker	Built-in Mic & Speaker	IN: 1 line OUT: 1 line Built-in Mic & Speaker	IN: 1 line OUT: 1 line Built-in Mic & Speaker	IN: 1 line OUT: 1 line Built-in Mic & Speaker
Alarm In / Out	1/1	-	1/1	1/1	1/1
MicroSD Storage	Up to 512 GB	up to 512 GB	Up to 256 GB	Up to 256 GB	Up to 256 GB
Protection	IP67	IP67	IP67	IP67	IP67
Power	12V DC, PoE	12 VDC, PoE	12V DC, PoE Max 12.5W	12V DC, PoE Max 12.5W	12V DC, PoE
Product QR Code					
Compatible Accessories	 LTB378 Pole Mount  LTB379 Corner Mount  LTB701 Junction Box  LTB342-140 Wall Mount  LTB341 Pendant Mount	 LTB342-140 Wall Mount  LTB701 Junction Box	 LTB378 Pole Mount  LTB379 Corner Mount  LTB701 Junction Box  LTB342-140 Wall Mount  LTB341 Pendant Mount	 LTB378 Pole Mount  LTB379 Corner Mount  LTB342-155 Wall Mount  LTB722 Junction Box  LTB341 Pendant Mount	 LTB378 Pole Mount  LTB379 Corner Mount  LTB801 Junction Box

*CMIP384PW-28SDL, CMIP3C6PW-28SDL, CMIP3C8PW-SDL, CMIP9C8PW-SDL can work with LTN87Q Series, LTN87D Series, LTN86D Series and LTN89/86 Series NVRs.

Ultimate 5-in-one Instadome Camera

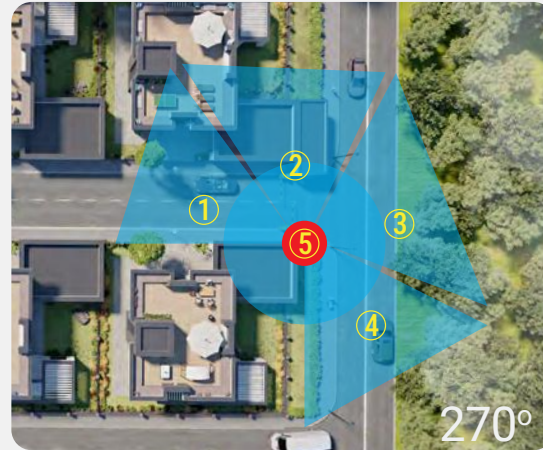

This camera features five multi-directional lens to protect you from all angles. Its greatest strength is the InstaDome technology for remotely adjustable lenses, which allows you to ideally adjust the five lenses to suit your installation site.

Versatile, Customizable Lens for Any Application

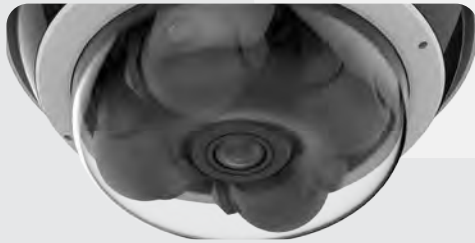

This camera has five lenses that are easily adjustable to cover angles such as 360° and 270° to secure your property from all angles. You can customize the lens configuration for different application settings, such as parking lots and corner buildings.

Save Labor Costs with One PoE Cable for Multi-lens Cameras



We are significantly reducing labor costs by utilizing a single PoE (Power over Ethernet) cable to support a camera with five lenses. This approach eliminates the need for five separate cables and cameras, streamlining installation and maintenance while improving efficiency.

InstaDome Technology

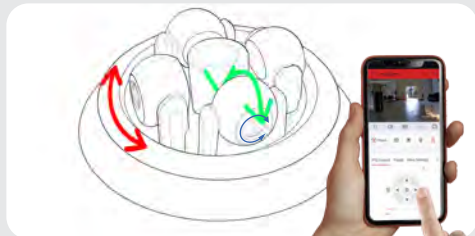

















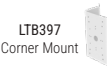









The camera has a removable plate and organized wire junction box, making installation up to 5X faster. Installers can remotely adjust the pan, tilt, zoom, and z-axis lens via the app to fit your installation site's pain points.

Blind Spot Protection

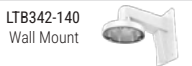

Unlike other cameras, this camera features a fixed lens at the bottom of the dome for a 360° FOV, enabling direct monitoring underneath.

Multi-lens IP Cameras		Dual Lens Camera
SKU	CMIP7553W5-SZ8	CMIP3743W2-DLZ
	 22MP 	 
Featuring		
Max. Resolution	Four: 2560 x 1920 @ 30 fps One: 1440 x 1440 @ 30 fps	Channel 1: 2688 x 1520, Channel 2: 2688 x 1520
Lens	4 x 2.8 - 8 mm, Remotely Adjustable Lenses for Pan, Tilt, Zoom, and Rotate; 1 x 2 mm, Fixed	Channel 1: Varifocal lens, motorized lens, 2.8 mm and 4 mm, Channel 2: Varifocal lens, motorized lens, 2.8 mm and 4 mm
Image Sensor	-	Channel 1: 1/3" Progressive Scan CMOS, Channel 2: 1/3" Progressive Scan CMOS
Special Features	VCA 2.0, Human/Vehicle Detection, WDR 120 dB, InstaDome	Hybrid Illumination, VCA 2.0, Active Deterrence with Red & Blue Strobe Lights, Human / Vehicle Detection, WDR 120dB
MicroSD Storage	Up to 1 TB	up to 512 GB
Audio In / Out	IN: 1 line OUT: 1 line	Built-in Mic & Speaker, Arrayed dual-mic
Alarm In / Out	2/2	-
Protection	IP67, IK10	IP67
Min. Illumination	0.005 Lux @ F1.2	Channel 1: Color: 0.005 Lux @ (F1.6, AGC ON), B/W: 0 Lux with IR, Channel 2: Color: 0.005 Lux @ (F1.6, AGC ON), B/W: 0 Lux with IR
Supplemental Lighting	Matrix IR LED up to 110 ft	-
Power	12V DC, PoE+	12VDC, PoE
Product QR Code		
Compatible Accessories	Compatible with Multi-Lens IP Cameras	
	 LTB742 Parapet Wall Mount  LTB397 Corner Mount  LTB378 Pole Mount  LTB751 Pendant Mount 20" (50cm)  LTB762 Wall Mount  LTB751-20 Pendant Mount 7.8" (20cm)	 LTB372WM Wall Mount  LTB373PM Pendant Mount

Fisheye IP Cameras		
SKU	CMIP7106F-SE	CMIP7112F-SE
	 	 12MP 
Featuring		
Max. Resolution	6 MP, 2560 x 2560 @ 30 fps	12 MP, 3504 x 3504 @ 30 fps
Lens	1.16 mm fisheye, Fixed	1.16 mm fisheye, Fixed
View	360° fisheye, 180° panoramic	360° fisheye, 180° panoramic
Mode	Multiple Viewing Modes and Virtual PTZ	Multiple Viewing Modes and Virtual PTZ
Supplemental Lighting	IR up to 50 ft	IR up to 50 ft
Min. Illumination	Color: 0.01 Lux @ F2.25, AGC ON B/W: 0.005 Lux @ F2.25, AGC ON B/W: 0 Lux with IR	Color: 0.03 Lux @ F2.2, AGC ON B/W: 0.006 Lux @ F2.2, AGC ON B/W: 0 Lux with IR
MicroSD Storage	Up to 512 GB	Up to 512 GB
Special Features	Human/Vehicle Detection, VCA 2.0, Digital WDR, Heat Mapping, Dewarping, People Counting, Queue Management	Human/Vehicle Detection, VCA 2.0, Digital WDR, Heat Mapping, Dewarping, People Counting, Queue Management
Audio / Alarm	IN: 1 line OUT: 1 line 4 Built-in Mics, 1 Built-in Speaker	2/2 IN: 1 line OUT: 1 line 4 Built-in Mics, 1 Built-in Speaker
Protection	IP67, IK10	IP67, IK10
Power	12V DC, PoE	12V DC, PoE
Product QR Code		
Compatible Accessories	Compatible with All Cameras Above	
	 LTB701 LTB701BK Junction Box (White/Black)  LTB342-140 Wall Mount  LTB342-JBOX Junction Box for LTB342-140	
	 LTB341 Pendant Mount  LTB378 Pole Mount  LTB379 Corner Mount	

Best of Both Worlds: Exceptional Detail and Wide Coverage



The panoramic PTZ camera, which features two separate cameras in one unit, is an excellent choice for monitoring vast areas. The 180° panoramic camera on top captures high-quality images of vast spaces. The PTZ camera below uses a 25x zoom lens to deliver detailed, clear

180° Wide Angle Coverage



The 180° panoramic camera covers vast, broad areas, making it perfect for applications such as roads, railways, airports, public venues, and more.

25x Zoom Lens for Long-Range

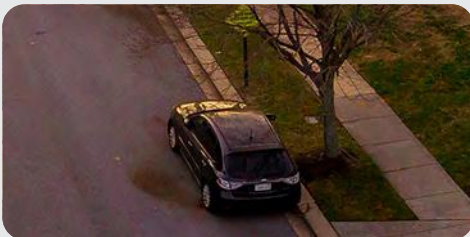

The PTZ camera below has a 25x zoom lens, which provides detailed, close-up images for tracking humans or vehicles.

Save Labor Costs with One Installation

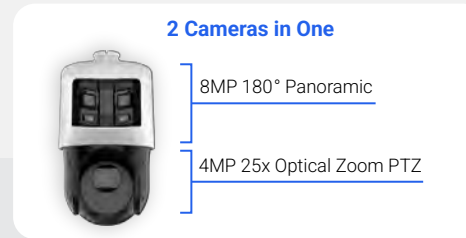





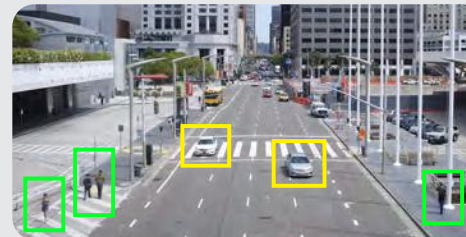



































The panoramic and PTZ lenses offer coverage of multiple angles, making it a tremendous cost-efficient solution. A single PoE (Power over Ethernet) cable can support a camera with three lenses to save labor costs.

Human & Vehicles Auto-tracking



This panoramic PTZ can zoom in and auto-track humans and vehicles, ensuring your property is safe in sensitive, restricted areas.

PTZ IP Cameras

SKU	PTZIP4C84W-X25IR	PTZIP4C44W-X25IR	PTZIP772NW-X32IR	PTZIP778NW-X25IR
	  			 
Featuring	      	      	      	       
Max. Resolution	Fixed: 8 MP 3840 x 2160 @ 20 fps PTZ: 4 MP 2560 x 1440 @ 30 fps	Fixed & PTZ Lens: 4 MP 2560 x 1440 @ 30 fps	2.1 MP, 1920 x 1080 @ 30 fps	8 MP, 3840 x 2160 @ 24 fps
Image Sensor	Fixed: 1/2.5" CMOS; PTZ: 1/2.8" CMOS	Fixed: 1/3" CMOS; PTZ: 1/2.8" CMOS	1/2.8" CMOS	1/1.8" CMOS
Lens(es) and Zoom	Fixed: 2.8 mm Panoramic, 180° Horizontal, 80° Vertical PTZ: 4.8 - 120 mm, 25x Optical Zoom, Auto Focus, Tracking	Fixed: 2.8 mm; PTZ: 4.8 - 120 mm, 25x Optical Zoom, Auto Focus	4.8 - 153 mm, 32x Optical Zoom, Auto Focus	5.9 - 147.5 mm, 25x Optical Zoom, Auto Focus
Min. Illumination	Fixed: 0.0005 Lux @ F1.0; PTZ: 0.005 Lux @ F1.6, AGC ON	Fixed: 0.0005 Lux @ F1.0; PTZ: 0.005 Lux @ F1.6, AGC ON	0.005 Lux @ F1.6	0.005 Lux @ F1.5
Supplemental Lighting	Fixed: White LED up to 100 ft PTZ: IR LED up to 300 ft	Fixed: White LED up to 98 ft; PTZ: IR LED up to 328 ft	IR LEDs up to 656 ft	IR LEDs up to 656 ft
Special Features	Color 24/7, VCA 2.0, Human/Vehicle Detection, Face Capture (PTZ Only), Smart Tracking with Human/Vehicle Classification	Color 24/7, VCA 2.0, Human/Vehicle Detection, Face Capture (PTZ Only), Smart Tracking with Human/Vehicle Classification	VCA 2.0, Active Deterrence with White Strobe light, Human/Vehicle Detection, Face Capture, Smart Tracking with Human/Vehicle Classification	VCA 2.0, Active Deterrence with White Strobe light, Human/Vehicle Detection, Face Capture, Smart Tracking with Human/Vehicle Classification
MicroSD Storage	Up to 256 GB	Up to 256 GB	Up to 256 GB	Up to 256 GB
Range of Motion	Pan 0° - 360°, Tilt -15° to - 90° (Auto flip)	Pan 0° - 360°, Tilt -15° - 90° (Auto-flip)	Pan 0° - 360°, Tilt -15° to - 90° (Auto flip)	Pan 0° - 360°, Tilt -15° to - 90° (Auto flip)
Image Enhancement	Panoramic: Digital WDR PTZ: 120dB WDR	WDR 120 dB	WDR 120 dB	WDR 120 dB
Audio In / Out	IN: 1 line OUT: 1 line	IN: 1 line OUT: 1 line	IN: 1 line OUT: 1 line Built-in Speaker	IN: 1 line OUT: 1 line Built-in Speaker
Alarm In / Out	1/1	1/1	2/1	2/1
Protection	IP66	IP66	IP66	IP66, IK10
Power	12V DC, PoE+ (802.3at), Max 24 W (max. 11 W for supplemental light, max. 2.6 W for heater)	12V DC, PoE+ (802.3at), Max 24W	24 VAC, High PoE Max 42W (max. 18W for IR, max. 10W for heater)	24 VAC, High PoE Max 42W (max. 18W for IR, max. 10W for heater)
Dimensions	φ 4"	φ 4"	φ 7"	φ 7"
Product QR Code	Wall Mount Bracket (LTB212) Included, PoE+ (30W) Sold Separately 	Wall Mount Bracket (LTB212) Included, PoE+ (30W) Sold Separately 	Wall Mount Bracket (LTB762) Included, High PoE Injector (60W) Sold Separately 	Wall Mount Bracket (LTB762) Included, High PoE Injector (60W) Sold Separately 

Compatible with All Cameras Above

Compatible Accessories								
	LTB751-20 Pendant Mount 7.8" (20cm)	LTB751 Pendant Mount 20" (50cm)	LTB742 Parapet Wall Mount	LTB762 Wall Mount	LTB378 Pole Mount (Must Use LTB762)	LTB379 Corner Mount (Must Use LTB762)	LTB397 Corner Mount (Must Use LTB212 or LTB762)	POE-PTZPi60N High PoE+ (60W)

*Facial Recognition feature is only available with compatible NVR (-D) models.

NVR

IP Cameras

















DVR







TVI

Defendas

Intercom + AC





























Accessories

PTZ IP Cameras										
SKU	PTZIP424W-X25IR		PTZIP514NW-X25IR							
										
Featuring										
Max. Resolution	4 MP, 2560 x 1440 @ 30 fps		4 MP, 2560 x 1440 @ 30 fps							
Image Sensor	1/2.8" CMOS		1/2.8" CMOS							
Lens and Zoom	4.8 - 120 mm, 25x Optical Zoom, Auto Focus, Auto Tracking		4.8 - 120 mm, 25x Optical Zoom, Auto Focus							
Min. Illumination	0.005 Lux @ F1.6		0.005 Lux @ F1.6							
Supplemental Lighting	IR LEDs up to 164 ft, Auto Intensity Adjustment		IR LEDs up to 492 ft							
Special Features	VCA 2.0, Human/Vehicle Detection, Face Capture, Smart Tracking with Human/Vehicle Classification		VCA 2.0, Human/Vehicle Detection, Face Capture, Smart Tracking with Human/Vehicle Classification							
MicroSD Storage	Up to 256 GB		Up to 256 GB							
Range of Motion	Pan 0° - 360°, Tilt -5° - 90°		Pan 0° - 360°, Tilt -15° to - 90° (Auto flip)							
Image Enhancement	WDR 120 dB		WDR 120 dB							
Audio In / Out	IN: 1 line OUT: 1 line		IN: 1 line OUT: 1 line							
Alarm In / Out	2/2		2/1							
Protection	IP66		IP66							
Power	12V DC, PoE+ (802.3at), Max 24W		24 VAC, PoE+ (802.3at), Max 24W (max. 9 W for IR and max. 1.6 W for heater)							
Dimensions	Φ 4"		Φ 5"							
Product QR Code	Wall Mount Bracket (LTB412) Included, PoE+ (30W) Sold Separately		Wall Mount Bracket (LTB762) Included, PoE+ (30W) Sold Separately							
Compatible Accessories	 LTB412 Wall Mount	 LTB378 Pole Mount	 LTB379 Corner Mount	 LTB342-JBOX Junction Box	 LTB751-20 Pendant Mount 7.8" (20cm)	 LTB751 Pendant Mount 20" (50cm)	 LTB742 Paraget Wall Mount	 LTB378 Pole Mount (Must use LTB762)	 LTB397 Corner Mount (Must Use LTB212 or LTB762)	 LTB762 Wall Mount

Palm-size PTZ IP Cameras			
SKU	PTZIP204W-X4IR		
			
Featuring			
Max. Resolution	4 MP, 2560 x 1440 @ 30 fps		
Image Sensor	1/3" CMOS		
Min. Illumination	0.005 Lux @ F1.6		
Lens and Zoom	2.8 - 12 mm, 4x Optical Zoom		
Supplemental Lighting	IR LEDs up to 66 ft, Auto Intensity Adjustment		
Range of Motion	Pan 0° - 330°, Tilt 0° - 90°		
Special Features	VCA 2.0, Human/Vehicle Detection, WDR 120 dB		
MicroSD Storage	Up to 256 GB		
Audio In / Out	IN: 1 line OUT: 1 line Built-in Mic		
Protection	IP66, IK10		
Power	12V DC, PoE Max 12W		
Dimensions	Φ 2.5"		
Product QR Code	PoE Injector and Wall Mount (LTB202) Sold Separately		
Compatible Accessories	 LTB347H/ LTB347HB Junction Box (White/Black)	 LTB202 Wall Mount	 LTB774 Pendant Mount 78" (200cm)

*Facial Recognition feature is only available with compatible NVR (-D) models.

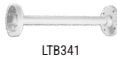
Turret IP Cameras

SKU	CMIP3342WI-28SDL CMIP3342WIB-28SDL	CMIP3382WI-28SDL CMIP3382WIB-28SDL	CMIP3283W-SDZ					
	  	  	 Junction Box Included					
Featuring								
Max. Resolution	4MP, 2688 × 1520 @ 30 fps	8MP, 3840 × 2160 @ 20 fps	8 MP, 3840 x 2160 @ 20 fps					
Image Sensor	1/2.9" Progressive Scan CMOS	1/2.8" Progressive Scan CMOS	1/2.8" Progressive Scan CMOS					
Lens	2.8 mm, Fixed	2.8 mm, Fixed	2.8 - 12 mm, Motorized					
Min. Illumination	Color: 0.005 Lux @ (F1.6, AGC ON), 0 Lux with light	Color: 0.005 Lux @ (F1.6, AGC ON), 0 Lux with light	0.005 Lux @ F1.6					
Smart Focus	-	-	Yes					
Supplemental Lighting	-	-	Matrix IR LED up to 130 ft					
Special Features	Hybrid Illumination, VCA 2.0, Human/Vehicle Detection, True WDR 120dB, Active Deterrence with Red & Blue Strobe Lights and Audio Alarm	Hybrid Illumination, VCA 2.0, Human/Vehicle Detection, True WDR 120dB, Active Deterrence with Red & Blue Strobe Lights and Audio Alarm	VCA 2.0, Human/Vehicle Detection, WDR 120 dB, Direct-Search and Facial Recognition					
Audio In / Out	Built-in Mic & Speaker, Arrayed Dual Mic	Built-in Mic & Speaker, Arrayed Dual Mic	IN: 1 line OUT: 1 line					
Alarm In / Out	-	-	1/1					
MicroSD Storage	Up to 512GB	Up to 512GB	Up to 256GB					
Protection	IP67	IP67	IP67, IK10					
Power	12V DC, PoE	12V DC, PoE	12V DC, PoE					
Product QR Code								
Compatible Accessories	 LTB301 Wall Mount	 LTB331 Pendant Mount	 LTB307 Junction Box	 LTB301 Wall Mount	 LTB331 Pendant Mount	 LTB307 Junction Box	 LTB701 Junction Box	 LTB342-140 Wall Mount
	 LTB03-W/ LTB03-BK Junction Box	 LTB378 Pole Mount	 LTB379 Corner Mount	 LTB03-W/ LTB03-BK Junction Box	 LTB378 Pole Mount	 LTB379 Corner Mount	 LTB341 Pendant Mount 22" (56cm)	 LTB378 Pole Mount

*Direct-Search and Facial Recognition features are only available with compatible NVR (-D) models.

NVR

IP Cameras

DVR





















TVI

Defendas

Intercom + AC

























Accessories

Mini Dome Fixed Lens IP Cameras

SKU	CMIP3142W-28SDA	CMIP3142W-28SDA-WIFI	CMIP3182W-28SDA	CMIP1C42W-28MDA	CMIP1C42WB-28MDA
					
Featuring					
Max. Resolution	4 MP, 2688 x 1520 @ 30 fps	4 MP, 2688 x 1520 @ 30 fps	8MP, 3840 x 2160 @ 30 fps	4MP, 2688 x 1520 @ 30 fps	4MP, 2688 x 1520 @ 30 fps
Lens	2.8 mm, Fixed	2.8 mm, Fixed	2.8mm, Fixed	2.8mm, Fixed	2.8mm, Fixed
Min. Illumination	0.005 Lux @ F1.6	0.005 Lux @ F1.6	0.005 Lux @ F1.6, AGC ON 0 Lux with IR	0.0005 Lux @ F1.0, AGC ON 0 Lux with suppl. Light	0.0005 Lux @ F1.0, AGC ON 0 Lux with suppl. Light
Supplemental Lighting	Matrix IR LED up to 100 ft	Matrix IR LED up to 100 ft	Matrix IR LED up to 100 ft	Matrix IR LED up to 100 ft	Matrix IR LED up to 100 ft
Special Features	VCA 2.0, Human/Vehicle Detection, WDR 120 dB, Direct-Search	VCA 2.0, Human/Vehicle Detection WDR 120 dB, Direct-Search	VCA 2.0, Human/Vehicle Detection, Direct-Search	Color 24/7, VCA 2.0, Human/Vehicle Detection, WDR 130dB, Direct-Search, Face Capture	Color 24/7, VCA 2.0, Human/Vehicle Detection, WDR 130dB, Direct-Search, Face Capture
Audio In / Out	IN: 1 line OUT: 1 line Built-in Mic	IN: 1 line OUT: 1 line Built-in Mic	IN: 1 line OUT: 1 line Built-in Mic	IN: 1 line OUT: 1 line Built-in Mic	IN: 1 line OUT: 1 line Built-in Mic
Alarm In / Out	1/1	1/1	1/1	1/1	1/1
Built-in Wi-Fi	-	2.4 GHz, 802.11g/n	-	-	-
MicroSD Storage	Up to 256 GB	Up to 256 GB	Up to 512 GB	Up to 512 GB	Up to 512 GB
Protection	IP67, IK8	IP67, IK8	IP67, IK8	IP67, IK8	IP67, IK8
Power	12V DC, PoE	12V DC, PoE	12V DC, PoE	12V DC, PoE	12V DC, PoE
Product QR Code					
Compatible Accessories	Compatible with All Cameras Above				
	 LTB347H/ LTB347HB Junction Box (White/Black)	 LTB742-120 Wall Mount	 LTB742-120B Wall Mount with Junction Box	 LTB731 Pendant Mount	 LTB378 Pole Mount

*Direct-Search and Facial Recognition features are only available with compatible NVR (-D) models.

Dome Fixed Lens IP Cameras

SKU	CMIP7342WI-28MDA	CMIP7382WI-28MDA				
	 	 				
						
Featuring	     	     				
Max. Resolution	4 MP, 2688 x 1520 @ 30 fps	8MP, 3840 x 2160 @ 20 fps				
Lens	2.8mm, Fixed	2.8 mm, Fixed				
Min. Illumination	Color: 0.005 Lux @ (F1.6, AGC ON), 0 Lux with light	Color: 0.005 Lux @ (F1.6, AGC ON), B/W: 0 Lux with light				
Image Sensor	1/2.9" Progressive Scan CMOS	1/2.8" Progressive Scan CMOS				
Special Features	Hybrid Illumination, VCA 2.0, Human/Vehicle Detection, True WDR 120dB	Hybrid Illumination, VCA 2.0, Human/Vehicle Detection, True WDR 120dB				
Audio In / Out	IN: 1 line OUT: 1 line Built-in Mic, Arrayed Dual-Mic	IN: 1 line OUT: 1 line Built-in Mic, Arrayed Dual-Mic				
Alarm In / Out	1/1	1/1				
MicroSD Storage	up to 512GB	up to 512GB				
Protection	IP67, IK10	IP67, IK10				
Power	12 VDC, PoE	12 VDC, PoE				
Product QR Code						
Compatible Accessories	Compatible with All Cameras Above					
	 <p>LTB347H Junction Box</p>	 <p>LTB742-120 Wall Mount</p>	 <p>LTB742-120B Wall Mount with Junction Box</p>	 <p>LTB731 Pendant Mount</p>	 <p>LTB378 Pole Mount</p>	 <p>LTB379 Corner Mount</p>

*Direct-Search feature is only available with compatible NVR (-D) models.

NVR

IP Cameras

DVR



















TVI

Defendas

Intercom + AC



















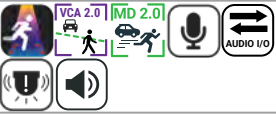

Accessories

Dome Vari-focal Lens IP Cameras

SKU	CMIP7243W-SDZ	CMIP7283W-SDZ	
	 Junction Box Included	  Junction Box Included	
Featuring	    	    	
Max. Resolution	4 MP, 2688 x 1520 @ 30 fps	8 MP, 3840 x 2160 @ 20 fps	
Lens	2.8 - 12 mm, VF, Motorized	2.8 - 12 mm, VF, Motorized	
Min. Illumination	0.005 Lux @ F1.6	0.005 Lux @ F1.6	
Supplemental Lighting	Matrix IR LED up to 130 ft	Matrix IR LED up to 130 ft	
Smart Focus	Yes	Yes	
Special Features	VCA 2.0, Human/Vehicle Detection, WDR 120 dB, Direct-Search	VCA 2.0, Human/Vehicle Detection, WDR 120 dB, Direct-Search	
Audio In / Out	IN: 1 line OUT: 1 line	IN: 1 line OUT: 1 line	
Alarm In / Out	1 / 1	1 / 1	
MicroSD Storage	Up to 256 GB	Up to 256 GB	
Protection	IP67, IK10	IP67, IK10	
Power	12V DC, PoE	12V DC, PoE	
Product QR Code			
	Compatible with All Cameras Above		
Compatible Accessories	 LTB342-155 Wall Mount	 LTB342-JBOX Junction Box for Wall Mount	 LTB378 Pole Mount
			 LTB379 Corner Mount













*Direct-Search feature is only available with compatible NVR (-D) models.

Bullet Vari-focal Lens IP Cameras **Bullet Fixed Lens IP Cameras**









SKU	CMIP9743W-SDZ	CMIP9783W-SDZ	CMIP9243W-SZ	CMIP9342WI-28SDL	CMIP9382WI-28SDL
	 Junction Box Included	 Junction Box Included	 Junction Box Included	 NEW	 NEW
Featuring					
Max. Resolution	4 MP, 2688 x 1520 @ 30 fps	8 MP, 3840 x 2160 @ 20 fps	4 MP, 2560 x 1440 @ 60 fps	4MP, 2688 x 1520 @ 30fps	8MP, 3840 x 2160 @ 20fps
Lens	2.8 - 12 mm, Motorized	2.8 - 12 mm, Motorized	4.7 - 118 mm, Motorized	2.8 mm, Fixed	2.8 mm, Fixed
Min. Illumination	0.005 Lux @ F1.6	0.005 Lux @ F1.6	0.007 Lux @ F1.2	Color: 0.005 Lux @ (F1.6, AGC ON), B/W: 0 Lux with IR	Color: 0.005 Lux @ (F1.6, AGC ON), B/W: 0 Lux with IR
Image Sens	1/3" Progressive Scan CMOS	1/2.8" Progressive Scan CMOS	1/2.5" Progressive Scan CMOS	1/2.9" Progressive Scan CMOS	1/2.8" Progressive Scan CMOS
Supplemental Lighting	Matrix IR LED up to 200 ft	Matrix IR LED up to 200 ft	IR up to 656 ft	-	-
Special Features	VCA 2.0, Human/Vehicle Detection WDR 120 dB, Direct-Search	VCA 2.0, Human/Vehicle Detection WDR 120 dB, Direct-Search	VCA 2.0, Human/Vehicle Detection, WDR 140 dB, Face Capture	Hybrid Illumination, VCA 2.0, True WDR 120dB, Human/Vehicle Detection, Active Deterrence with Red & Blue Strobe Lights and Audio Alarm	Hybrid Illumination, VCA 2.0, True WDR 120dB, Human/Vehicle Detection, Active Deterrence with Red & Blue Strobe Lights and Audio Alarm
Audio In / Out	IN: 1 line OUT: 1 line	IN: 1 line OUT: 1 line	IN: 1 line OUT: 1 line	IN: 1 line OUT: 1 line Built-in Mic & Speaker, Arrayed Dual-Mic	IN: 1 line OUT: 1 line Built-in Mic & Speaker, Arrayed Dual-Mic
Alarm In / Out	1 / 1	1 / 1	2 / 2	1/1	1/1
MicroSD Storage	Up to 256 GB	Up to 256 GB	Up to 128 GB	up to 512GB	up to 512GB
Protection	IP67, IK10	IP67, IK10	IP67, IK10	IP67	IP67
Power	12V DC, PoE	12V DC, PoE	12V DC, PoE	12 VDC, PoE	12 VDC, PoE
Product QR Code					
Compatible Accessories	 LTB378 Pole Mount  LTB379 Corner Mount	 LTB378 Pole Mount  LTB379 Corner Mount	 LTB388 Pole Mount  LTB389 Corner Mount	 LTB801 Junction Box  LTB378 Pole Mount  LTB379 Corner Mount	 LTB801 Junction Box  LTB378 Pole Mount  LTB379 Corner Mount































*Direct-Search feature is only available with compatible NVR (-D) models.

Turret Fixed Lens IP Cameras



















SKU	CMIP1342WE-28MDA	CMIP1382NW-28MA	CMIP1382WE-28MDA
			
Featuring	  		  
Max. Resolution	4 MP, 2560 x 1440 @ 20 fps	8 MP, 3840 x 2160 @ 15 fps	8 MP, 3840 x 2160 @ 15 fps
Lens	2.8 mm, Fixed	2.8 mm, Fixed	2.8 mm, Fixed
Min. Illumination	0.005 Lux @ F1.6	0.01 Lux @ F2.0	0.01 Lux @ F2.0
Smart Focus	-	-	-
Supplemental Lighting	Matrix IR and White Light up to 100 ft	Matrix IR LED up to 100 ft	Matrix IR and White Light up to 100 ft
Special Features	Hybrid Illumination, Human/Vehicle Detection, WDR 120 dB	WDR 120 dB	Hybrid Illumination, Human/Vehicle Detection, WDR 120 dB
Audio In / Out	Built-in Mic	Built-in Mic	Built-in Mic
MicroSD Storage	Up to 512 GB	Up to 256 GB	Up to 512 GB
Protection	IP67	IP67	IP67
Power	12V DC, PoE	12V DC, PoE	12V DC, PoE
Product QR Code			

Compatible with All Cameras Above

















Compatible Accessories								
								
	LTB03-W Junction Box	LTB307 Junction Box	LTB301 Wall Mount	LTB342-JBOX Junction Box for Wall Mount	LTB371 Pendant Mount 21.5" (55cm)	LTB331 Pendant Mount 21.5" (55cm)	LTB378 Pole Mount	LTB379 Corner Mount

Turret Fixed Lens IP Cameras				Turret Vari-focal IP Cameras								
SKU	CMIP1042W-28MA				CMIP1043NW-MZ				CMIP1043W-MDZ			
												
Featuring												
Max. Resolution	4 MP, 2560 x 1440 @ 20 fps				4 MP, 2560 x 1440 @ 20 fps				4MP, 2560 x 1440 @ 24 fps			
Lens	2.8 mm, Fixed				2.8 - 12 mm, VF, Motorized				2.8 - 12 mm, Motorized			
Min. Illumination	0.01 Lux @ F2.0				0.005 Lux @ F1.6				0.005 Lux @ F1.6, AGC ON 0 Lux with IR			
Smart Focus	-				Yes				-			
Supplemental Lighting	Matrix IR LED up to 100 ft				Matrix IR LED up to 100 ft				Matrix IR LED up to 100 ft			
Special Features	WDR 120 dB				WDR 120 dB				Human/Vehicle Detection, WDR 120dB			
Audio In / Out	Built-in Mic				-				IN: 1 line OUT: 1 line			
MicroSD Storage	Up to 256 GB				Up to 256 GB				Up to 256 GB			
Protection	IP67				IP67				IP67			
Power	12V DC, PoE				12V DC, PoE				12V DC, PoE			
Product QR Code												
Compatible Accessories												
												







Dome IP Cameras

SKU	CMIP7042W-28MA			CMIP7043NW-MZ		
						
Featuring	 					
Max. Resolution	4 MP, 2560 x 1440 @ 20 fps			4 MP, 2560 x 1440 @ 20 fps		
Lens	2.8 mm, Fixed			2.8 - 12 mm, VF, Motorized		
Min. Illumination	0.01 Lux @ F2.0			0.005 Lux @ F1.6		
Supplemental Lighting	IR LED up to 100 ft			Matrix IR LED up to 100 ft		
Special Features	WDR 120 dB			WDR 120 dB		
Audio In / Out	Built-in Mic			-		
MicroSD Storage	Up to 256 GB			Up to 256 GB		
Range of Motion	2-Axis			3-Axis		
Protection	IP67, IK10			IP67, IK10		
Power	12V DC, PoE			12V DC, PoE		
Product QR Code						
Compatible Accessories	 LTB347H Junction Box	 LTB742-120 Wall Mount	 LTB742-120B Wall Mount with Junction Box	 LTB701 Junction Box	 LTB342-135B Wall Mount with Junction Box	 LTB381 Pendant Mount 22" (56cm)
	 LTB731 Pendant Mount	 LTB378 Pole Mount	 LTB379 Corner Mount	 LTB378 Pole Mount		 LTB379 Corner Mount

Bullet IP Cameras

SKU	CMIP8042W-28MA	CMIP8043NW-MZ	CMIP8043W-MDZ				
							
Featuring			 				
Max. Resolution	4 MP, 2560 x 1440 @ 20 fps	4 MP, 2560 x 1440 @ 20 fps	4MP, 2560 x 1440 @ 24 fps				
Lens	2.8 mm, Fixed	2.8 - 12 mm, VF, Motorized	2.8 - 12 mm, Motorized				
Min. Illumination	0.01 Lux @ F2.0	0.005 Lux @ F1.6	0.005 Lux @ F1.6, AGC ON 0 Lux with IR				
Smart Focus	-	Yes	-				
Supplemental Lighting	Matrix IR LED up to 100 ft	Matrix IR LED up to 165 ft	Matrix IR LED up to 165 ft				
Special Features	WDR 120 dB	WDR 120 dB	Human/Vehicle Detection, WDR 120dB				
Audio In / Out	Built-in Mic	-	IN: 1 line OUT: 1 line				
MicroSD Storage	Up to 256 GB	Up to 256 GB	Up to 256 GB				
Protection	IP67	IP67	IP67				
Power	12V DC, PoE	12V DC, PoE	12V DC, PoE				
Product QR Code							
Compatible Accessories	 LTB345 Junction Box	 LTB801 Junction Box	 LTB8378 Pole Mount	 LTB8379 Corner Mount	 LTB801 Junction Box	 LTB8378 Pole Mount	 LTB8379 Corner Mount

Indoor Wi-Fi IP Camera

SKU	CMIP8942W-28SDA-WIFI
	
Featuring	    
Max. Resolution	4 MP, 2688 x 1520 @ 30 fps
Lens	2.8 mm, Fixed
Min. Illumination	0.005 Lux @ F1.6
Compression	H.265+/H.265/H.264+/H.264
Supplemental Lighting	Matrix IR LED up to 33 ft
Special Features	VCA2.0, WDR 120dB, Direct-Search
Audio In / Out	Built-in Mic & Speaker
Built-in Wi-Fi	2.4 Ghz, 802.11b/g/n
MicroSD Storage	Up to 256 GB
Range of Motion	Pan 0° - 360°, Tilt 0° - 90°, Rotate 0° - 360°
Power	12V DC, PoE
Product QR Code	

NVR

IP Cameras

DVR



TVI



Defendas

Intercom + AC

























Accessories

Enterprise Level DVR

SKU	LTD8416M-ST(S)	LTD8432M-EA(S)	LTD8432M-ST(S)
	 		 
Featuring			
Analog Video Input	16 Ch (TVI / AHD / CVI / CVBS) up to 8 MP	32 Ch (HD-TVI / AHD / CVI / CVBS) up to 4 MP	32 Ch (HD-TVI / AHD / CVI / CVBS) up to 8 MP
Analog Record Rate	8 MP @ 8 fps / 5 MP @ 12 fps / 2 MP @ 30 fps	4 MP Lite @ 15 fps / 1080p @ 15 fps	8 MP @ 8 fps / 5 MP @ 12 fps / 3 MP @ 18 fps
IPC Input	18 Ch, up to 12 MP, adjustable up to 34 Ch	16 Ch up to 6 MP, adjustable up to 48 Ch	32 Ch up to 12 MP, adjustable up to 64 Ch
Total Bandwidth	In: 160 Mbps; Out: 160 Mbps	In: 200 Mbps; Out: 160 Mbps	In: 320 Mbps; Out: 256 Mbps
Decoding Format	H.265 Pro+ / H.265 Pro / H.265 / H.264+ / H.264	H.265 Pro+ / H.265 Pro / H.265 / H.264+ / H.264	H.265 Pro+ / H.265 Pro / H.265 / H.264+ / H.264
Video Output	HDMI1 up to 4K (3840 x 2160) / VGA up to 1080p, HDMI2 up to 1080p, CVBS	HDMI1 / VGA up to 1920 x 1080, HDMI2 up to 4K (3840 x 2160), CVBS (704 x 480)	HDMI1 / VGA up to 1920 x 1080, HDMI2 up to 4K (3840 x 2160), CVBS (704 x 480)
Playback Channel	16 Ch	16 Ch	16 Ch
Audio In / Out	IN: 4 lines OUT: 2 lines RCA	IN: 4 lines OUT: 1 line RCA	IN: 4 lines OUT: 1 line RCA
Alarm Channels (In / Out)	16/4	16/4	16/4
Bandwidth, Connector	10/100/1000 Mbps, 2 x RJ45	10/100/1000 Mbps, 2 x RJ45	10/100/1000 Mbps, 2 x RJ45
Storage	4 x SATA up to 12 TB each, NAS, IP SAN	4 x SATA up to 12 TB each, NAS, IP SAN, support eSATA	4 x SATA up to 12 TB each, NAS, IP SAN, support eSATA
USB	2 x USB 2.0, 1 x USB 3.0	2 x USB 2.0, 1 x USB 3.0	2 x USB 2.0, 1 x USB 3.0
PTZ Control	RS-485 (Full-Duplex), Keyboard	RS-485 (Full-Duplex), Keyboard	RS-485 (Full-Duplex), Keyboard
POSs Supported	8 (TCP or RS232)	8 (TCP or RS232)	8 (TCP or RS232)
Dimensions (W x D x H)	17.5" x 15.7" x 2.8"	17.5" x 15.7" x 2.8"	17.5" x 15.7" x 2.8"
Product QR Code			

Professional Level DVR			
SKU	LTD8304D-ET	LTD8308D-ETC	LTD8316D-ET
	 	 	 
Featuring			
Video Input	4 Channels (TVI / AHD / CVI / CVBS / IP), up to 4 MP	8 Channels (TVI / AHD / CVI / CVBS / IP), up to 4 MP	16 Channels (TVI / AHD / CVI / CVBS / IP), up to 4 MP
Analog Record Rate	4 MP Lite @ 15 fps, 1080p @ 15 fps	4 MP Lite @ 15 fps, 1080p @ 15 fps	4 MP Lite @ 15 fps, 1080p @ 15 fps
IPC Input	Standard Mode: 1 channel (up to 5) Enhanced IP Mode: 2 channels (up to 6) @ up to 4 Mbps each. Up to 6 MP	Standard Mode: 2 channels (up to 10) Enhanced IP Mode: 4 channels (up to 12) @ up to 4 Mbps each. Up to 6 MP	8 channels (up to 24) @ up to 4 Mbps each, up to 6 MP
Total Bandwidth	72 Mbps	96 Mbps	128 Mbps
Video Output	VGA / HDMI up to 1920 x 1080, CVBS	VGA / HDMI up to 1920 x 1080, CVBS	HDMI (4k) / VGA up to 1080P
Decoding Format	H.265 Pro+/H.265 Pro/ H.265/H.264+/H.264	H.265 Pro+/H.265 Pro/ H.265/H.264+/H.264	H.265 Pro+/H.265 Pro/ H.265/H.264+/H.264
Deep Learning Support	Human / Vehicle Detection, or 2 ch. of Human/Vehicle Detection VCA, or 1 ch. Facial Recognition, or 2 ch. Direct-Search	Human / Vehicle Detection, or 4 ch. Human/Vehicle Detection VCA, or 2 ch. Facial Recognition, or 4 ch. Direct-Search	Human / Vehicle Detection, or 8 ch. Human/Vehicle Detection VCA, or 4 ch. Facial Recognition, or 8 ch. Direct-Search
Playback Channel	4 Ch	8 Ch	16 Ch
Audio In / Out	IN: 1 line OUT: 1 line RCA 4, coaxial cable (input)	IN: 1 line OUT: 1 line RCA 8, coaxial cable (input)	IN: 1 line OUT: 1 line RCA 16, coaxial cable (input)
Alarm Channels (In / Out)	-	-	-
Network Interface	10/100 Mbps, 1 x RJ45	10/100 Mbps, 1 x RJ45	10/100/1000 Mbps, 1 x RJ45
Storage	1 x SATA up to 10 TB	1 x SATA up to 10 TB	2 x SATA up to 12 TB each
PTZ Control	RS485	RS485	RS485
USB	2 x USB 2.0	2 x USB 2.0	1 x USB 2.0, 1 x USB 3.0
Dimensions (W x D x H)	12.6 x 9.3 x 1.9"	12.4 x 9.5 x 1.9"	15.1 x 12.5 x 2.0"
Product QR Code			

Professional Level DVR

SKU	LTD8504D-ST	LTD8508D-STC	LTD8516D-ST
	  	  	  
Featuring	   	   	   
Video Input	4 Channels (TVI / AHD / CVI / CVBS / IP), up to 8 MP	8 Channels (TVI / AHD / CVI / CVBS / IP), up to 8 MP	16 Channels (TVI / AHD / CVI / CVBS / IP), up to 8 MP
Analog Record Rate	1st ch. up to 8 MP @ 8 fps / 5 MP @ 12 fps / 2 MP @ 30 fps	8 MP @ 8 fps / 5 MP @ 12 fps / 2 MP @ 30 fps	8 MP @ 8 fps / 5 MP @ 12 fps / 2 MP @ 30 fps
IPC Input	Standard Mode: 2 channels (up to 6) Enhanced IP Mode: 4 channels (up to 8) @ up to 4 Mbps each Up to 8 MP	8 channels (up to 16) @ up to 4 Mbps each, up to 8 MP	16 channels (up to 32) @ up to 4 Mbps each, up to 8 MP
Total Bandwidth	96 Mbps	128 Mbps	128 Mbps
Video Output	HDMI (2k) / VGA up to 1080P	HDMI (4k) / VGA up to 1080P	HDMI (4k) / VGA up to 1080P
Decoding Format	H.265 Pro+/H.265 Pro/ H.265/H.264+/H.264	H.265 Pro+/H.265 Pro/ H.265/H.264+/H.264	H.265 Pro+/H.265 Pro/ H.265/H.264+/H.264
Deep Learning Support	Human / Vehicle Detection, or 4 ch. Human/Vehicle Detection VCA, or 2 ch. Facial Recognition, or 4 ch. Direct-Search	Human / Vehicle Detection, or 8 ch. Human/Vehicle Detection VCA, or 4 ch. Facial Recognition, or 8 ch. Direct-Search	MD, 2.0 or 8 ch. Human/Vehicle Detection VCA, or 4 ch. Facial Recognition, or 8 ch. Direct-Search
Playback Channel	4 Ch	8 Ch	16 Ch
Audio In / Out	IN: 1 line OUT: 1 line RCA 4, coaxial cable (input)	IN: 1 line OUT: 1 line RCA 8, coaxial cable (input)	IN: 4 line OUT: 1 line RCA 16, coaxial cable (input)
Alarm Channels (In / Out)	-	-	-
Network Interface	10/100 Mbps, 1 x RJ45	10/100/1000 Mbps, 1 x RJ45	10/100/1000 Mbps, 1 x RJ45
Storage	1 x SATA up to 10 TB	1 x SATA up to 12 TB	2 x SATA up to 12 TB each, NAS, IP SAN
PTZ Control	RS485	RS485	RS485
USB	2 x USB 2.0	1 x USB 2.0, 1 x USB 3.0	1 x USB 2.0, 1 x USB 3.0
Dimensions (W x D x H)	12.4 x 9.5 x 1.8"	12.4 x 9.5 x 1.8"	15 x 12.6 x 1.9"
Product QR Code			

Invest in Care, Skip the Repair



With powerful strobe lights, and two-way audio, TVI cameras are proactive against break-ins, significantly minimizing the need for costly property repairs. TVI cameras require compatible DVR models for MD 2.0 Human/Vehicle Detection.

Active Deterrence



This camera flashes red and blue strobe lights to deter intruders once they enter the detection zone proactively.

Two-Way Audio



If you encounter loiterers or personnel, you can use the two-way speakers to communicate and discourage access.

180° Coverage







































In addition to the strobe lights, these cameras have 180° coverage to monitor every angle—because total awareness means total protection.

VCA with Human & Vehicle Detection

































When paired with compatible DVRs, our cameras deliver enhanced detection accuracy—effectively distinguishing between relevant and irrelevant motion to minimize false alarms.

Color 24/7 HD-TVI Cameras

SKU	CMHT1722NW-28CF	CMHT1752W-28CF	CMHT1782W-28CF	CMHT3C5PW-28L										
														
Featuring				  										
Max. Resolution	2 MP, 1920 x 1080 @ 30 fps	5 MP, 2560 x 1944 @ 20 fps	8 MP, 3840 x 2160 @ 15 fps	5 MP, 3328 x 1504 @ 20 fps										
Lens	2.8 mm, Fixed	2.8 mm, Fixed	2.8 mm, Fixed	2 x 2.8 mm, Fixed										
Min. Illumination	0.0005 Lux @ F1.0	0.0005 Lux @ F1.0	0.0005 Lux @ F1.0	0.0005 Lux @ F 1.0, AGC ON, 0 Lux with suppl. light										
Supplemental Lighting	White LEDs up to 131 ft	White LEDs up to 65 ft	White LEDs up to 130 ft	IR and White light up to 131 ft										
Special Features	Color 24/7	Color 24/7	Color 24/7	Color 24/7, Hybrid Illumination										
WDR	WDR 130 dB	WDR 130 dB	WDR 130 dB	WDR 130 dB										
Output	TVI / AHD / CVI / CVBS Switchable	TVI / AHD / CVI / CVBS Switchable	TVI	TVI										
Audio In/Out	-	-	-	Built-in Mic										
Protection	IP67	IP67	IP67	IP67										
Power	12V DC	12V DC	12V DC	12V DC										
Product QR Code														
Compatible Accessories	 LTB03-W Junction Box	 LTB307 Junction Box	 LTB342-JBOX Junction Box for Wall Mount LTB301	 LTB371 Pendant Mount 21.5" (55cm)	 LTB03-W Junction Box	 LTB307 Junction Box	 LTB342-JBOX Junction Box for Wall Mount LTB301	 LTB371 Pendant Mount 21.5" (55cm)	 LTB03-W Junction Box	 LTB307 Junction Box	 LTB342-JBOX Junction Box for Wall Mount LTB301	 LTB371 Pendant Mount 21.5" (55cm)	 LTB342-140 Wall Mount	 LTB701 Junction Box
	 LTB378 Pole Mount	 LTB379 Corner Mount	 LTB301 Wall Mount	 LTB378 Pole Mount	 LTB379 Corner Mount	 LTB301 Wall Mount	 LTB378 Pole Mount	 LTB379 Corner Mount	 LTB301 Wall Mount					

*Please note CMHT3C5PW-28L requires LTD83D or LTD85D Series DVR with latest firmware to work.

Turret Fixed Lens HD-TVI Cameras

SKU	CMHT2122-28LF	CMHT1722-28LS	CMHT1722WE-28F									
		 										
Featuring			   									
Max. Resolution	2 MP, 1920 x 1080 @ 30 fps	2 MP, 1920 x 1080 @ 30 fps	2 MP, 1920 x 1080 @ 30 fps									
Lens	2.8 mm, Fixed	2.8 mm, Fixed	2.8 mm, Fixed									
Min. Illumination	0.02 Lux @ F2.2	0.01 Lux @ F1.6	0.003 Lux @ F1.2									
Supplemental Lighting	IR/White Light up to 65 ft	IR/White Light up to 130 ft	Matrix IR up to 197 ft									
Special Features	Hybrid Illumination	Hybrid Illumination, Active Deterrence with Red & Blue Strobe Light & Siren	-									
WDR	DWDR	DWDR	WDR 130 dB									
Output	TVI / AHD / CVI / CVBS Switchable	TVI	TVI / AHD / CVI / CVBS Switchable									
Audio In / Out	-	Built-in Mic & Speaker	-									
Protection	IP67	IP67	IP67									
Power	12V DC	12V DC	12V DC									
Product QR Code												
Compatible Accessories	 LTB378 Pole Mount	 LTB379 Corner Mount	 LTB345 Junction Box	 LTB342-110T Wall Mount	 LTB378 Pole Mount	 LTB379 Corner Mount	 LTB301 Wall Mount	 LTB03-W Junction Box	 LTB378 Pole Mount	 LTB379 Corner Mount	 LTB301 Wall Mount	 LTB03-W Junction Box
					 LTB342-JBOX Junction Box for Wall Mount LTB301	 LTB307 Junction Box	 LTB371 Pendant Mount 21.5" (55cm)	 LTB342-JBOX Junction Box for Wall Mount LTB301	 LTB307 Junction Box	 LTB371 Pendant Mount 21.5" (55cm)		

*Please note CMHT1722-28LS only works with compatible DVR models.











Turret Fixed Lens HD-TVI Cameras

SKU	CMHT2152-28LFA	CMHT1752WE-28F	CMHT1782-28LF	CMHT1752-28LS										
														
Featuring	 			   										
Max. Resolution	5 MP, 2960 x 1665 @ 20 fps	5 MP, 2560 x 1944 @ 20 fps	8 MP, 3840 x 2160 @ 15 fps	5MP, 2960x1665 @ 25 fps										
Lens	2.8 mm, Fixed	2.8 mm, Fixed	2.8 mm	2.8mm, Fixed										
Min. Illumination	0.01 Lux @ F1.2	0.003 Lux @ F1.2	0.01 Lux @ F1.6	0.01 Lux @ F1.6										
Supplemental Lighting	IR up to 100 ft, White Light up to 66 ft	Matrix IR up to 200 ft	IR up to 130 ft, White Light up to 66 ft	IR/White Light up to 130 ft										
Special Features	Hybrid Illumination	-	Hybrid Illumination	Hybrid Illumination, Active Deterrence with Red & Blue Strobe Light and Siren										
WDR	DWDR	WDR 130 dB	DWDR	DWDR										
Output	TVI / AHD / CVI / CVBS Switchable	TVI / AHD / CVI / CVBS Switchable	TVI / AHD / CVI / CVBS Switchable	TVI										
Audio In / Out	Built-in Mic	-	-	Built-in Mic & Speaker										
Protection	IP67	IP67	IP67	IP67										
Power	12V DC	12V DC	12V DC	12V DC										
Product QR Code														
Compatible Accessories	 LTB345 Junction Box	 LTB342-110T Wall Mount	 LTB342-JBOX Junction Box for Wall Mount LTB301	 LTB03-W Junction Box	 LTB307 Junction Box	 LTB301 Wall Mount	 LTB342-JBOX Junction Box for Wall Mount LTB301	 LTB03-W Junction Box	 LTB307 Junction Box	 LTB301 Wall Mount	 LTB342-JBOX Junction Box for Wall Mount LTB301	 LTB03-W Junction Box	 LTB307 Junction Box	 LTB301 Wall Mount
	 LTB378 Pole Mount	 LTB379 Corner Mount	 LTB371 Pendant Mount 21.5" (55cm)	 LTB378 Pole Mount	 LTB379 Corner Mount	 LTB371 Pendant Mount 21.5" (55cm)	 LTB378 Pole Mount	 LTB379 Corner Mount	 LTB371 Pendant Mount 21.5" (55cm)	 LTB378 Pole Mount	 LTB379 Corner Mount			

Bullet Fixed Lens HD-TVI Cameras

SKU	CMHR9252WE-28F
	 Junction Box Included
Featuring	
Max. Resolution	5 MP, 2560 x 1944 @ 20 fps
Lens	2.8 mm, Fixed
Min. Illumination	0.003 Lux @ F1.2
Supplemental Lighting	Matrix IR up to 200 ft
Special Features	-
WDR	WDR 130 dB
Output	TVI / AHD / CVI / CVBS Switchable
Protection	IP67
Power	12V DC
Product QR Code	
Compatible Accessory	 LTB345 Junction Box

Dome Vari-focal Lens HD-TVI Cameras

SKU	CMHD3453D-ZFN		
	 		
Featuring			
Max. Resolution	5 MP, 2560 x 1944 @ 20 fps		
Lens	2.7 - 13.5 mm, Motorized		
Min. Illumination	0.01 Lux @ F1.2		
Supplemental Lighting	Matrix IR up to 130 ft		
Special Features	-		
WDR	DWDR		
Output	TVI / AHD / CVI / CVBS Switchable		
Protection	IP67, IK10		
Range of Motion	3-Axis		
Power	12V DC, 24V AC		
Product QR Code			
Compatible Accessories	Compatible with All Cameras Above		
	 LTB342-140 Wall Mount for CMHD3523DWE	 LTB342-JBOX Junction Box for Wall Mount LTB342-140	 LTB340 In-Ceiling Mount for CMHD3523DWE
	 LTB453 Junction Box for CMHD3453D-ZFN	 LTB378 Pole Mount	 LTB379 Corner Mount

Smarter Access Control, Simplified



UL 294 Certified

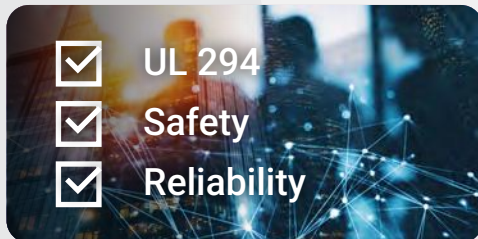

Our access control solutions are UL 294 certified, ensuring compliance with rigorous safety, performance, and reliability standards.

User-Level Access Management



Set the right access for the right people. Customize permissions by role to keep your system secure, organized, and easy to manage.

Mobile & Web Application

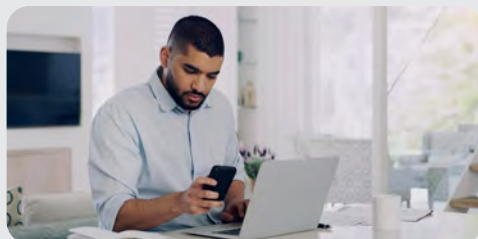









Our platform delivers seamless system control across web and mobile environments, enabling real-time monitoring, configuration, and event management from virtually anywhere.

Built-in PoE and Wi-Fi Capabilities



Integrated PoE and Wi-Fi capabilities enable flexible installations with fewer components, minimizing infrastructure requirements and reducing overall deployment costs.

Defendas Sentinel Series				
SKU	ST200B ST400B	ST10-MEK	ST902-MEK	ST-ENROLL
				
Key Features	<ul style="list-style-type: none"> • 2- and 4-door options • Built-in web application • PoE • Wi-Fi • Black metal casing • UL294 Certified 	<ul style="list-style-type: none"> • IP66 and IK07 protection • Card or card with password • Wiegand and RS485 (OSDP) • 125KHz (EM) and 13.56MHz (Mifare) cards • Bluetooth + mobile credential • NFC • QR-code scanning • Touch keypad (PIN) • UL294 Certified 	<ul style="list-style-type: none"> • IP65 protection • Card or card with password • Wiegand and RS485 (OSDP) • 125KHz (EM) and 13.56MHz (Mifare) cards • UL294 Certified 	<ul style="list-style-type: none"> • EM and Mifare card enrollment reader with USB connection
Product QR Code	<p>ST200B </p> <p>ST400B </p>			

NVR

IP Cameras

DVR

TVI

Defendas

Intercom + AC

Accessories



Download LTS Connect App on



Apple Store



Google Play



Download X-VMS App on













Apple Store

























Google Play

Intercom and Access Control

Scalable Entrance Security Solutions

IP Intercom Outdoor Station				
LTH-303M-WIFI	LTH-302M-PS	LTH-401M-WIFI	LTH-401M-PS	LTK3411MF
 Door Station with WDR 2 MP IPC <ul style="list-style-type: none"> • Compact 4.7" x 2.2" x 0.8" • MIFARE Reader Calling Button • Single Office Application, Call App Directly • PoE or TCP / IP with 12V DC, IP65 	 Protective Shield <ul style="list-style-type: none"> • 5.90" x 3.13" x 1.91" • Polycarbonate • Compatible with LTH-301M-WIFI, LTH302M-WIFI and LTH303M-WIFI • Surface Mount 	 IP Door Station with Contact List <ul style="list-style-type: none"> • 7.16" x 3.33" x 1.01" • Contact List Function • Supports up to 500 Contacts • 4" Touchscreen • Large Physical Call Button • Face, Card, Key fob, and Code Entry • PoE or 12V DC with Wi-Fi • IP65, IK8 Vandal-resistant 	 Protective Shield <ul style="list-style-type: none"> • 7.43" x 3.82" x 1.93" • Electro-Galvanized Steel Sheets • Compatible with LTH-401M-WIFI • Surface Mount 	 4" Touchscreen Door Station <ul style="list-style-type: none"> • 6.79" x 3.27" x 0.89" • Facial, Card, QR Code, and PIN • For Single Office: 1 Click Call App • For Multi-Tenant: Supports up to 500 Apartment Units • Add Indoor Station for App Access • IP65 • TCP / IP, 12V DC • Add LTK-AQE30E for PoE • Secure module LTH-SM1 via RS-485 





IP Intercom Indoor Station		Management Software Options		
LTH-D311GY-WIFI	LTH-D311-DESK	NVMS V3 PC Software + LTS Connect App	X-VMS VMS Windows Software + X-VMS App	LTKE100ME
 IP Video Indoor Station <ul style="list-style-type: none"> • 7" Touch Screen • New Design • NVMS V3 PC • Allows App Access for Door Stations • PoE, 12V DC, Wi-Fi • Up to 17 per Office 	 Desk Stand <ul style="list-style-type: none"> • Designed for LTH-D311GY-WIFI 	 Manage Surveillance, Access Control and Intercom <ul style="list-style-type: none"> • Only 1 PC for Access Control Purposes • LTS Connect App Supports Single Door Controllers and Intercom • Answer and Unlock Doors via App • Up to 256 Video and 50 Door Channels • Time Attendance, E-Map 	 VMS for LTS Surveillance, Access Control and Intercom <ul style="list-style-type: none"> • Supports Multiple Users from Different Computers and Smartphones • Controls Multi-Door and Single Door Controllers and Intercom • Project-based Pricing • Web for Config, Software for Operation 	 LTS MIFARE USB Issuer <ul style="list-style-type: none"> • Supports Both NVMS and X-VMS • Easy Enrolling Cards at Client PC • UL Listed 

Multi-Door Controller	Card Readers for LTS Controllers				MIFARE Credentials		
LTK2802 LTK2804	LTK1107M	LTK1107MK	LTK1108M	LTK1108MK	LTKC1356M	LTKF1356M	LTKF1356M-T
	 	 	 	 	 	 	 
LTS 2 Door Controller <ul style="list-style-type: none"> • Secure Metal Closure with Lock • Supports 4 Wiegand 26 / 34 bit Readers • Up to 10,000 Cards and 50,000 Events • Built-in 12V DC 8.5A Power Supply 	LTS 4 Door Controller <ul style="list-style-type: none"> • Secure Metal Closure with Lock • Supports 4 Wiegand 26 / 34 bit Readers • Up to 10,000 Cards and 50,000 Events • Built-in 12V DC 8.5A Power Supply 		LTS Slim Reader <ul style="list-style-type: none"> • Wiegand 26 / 34 • MIFARE Classic • IP65 • -K includes Keypad 	LTS Single Gang Reader <ul style="list-style-type: none"> • Wiegand 26 / 34 • MIFARE Classic • IP65 • -K includes Keypad 	LTS MIFARE Card <ul style="list-style-type: none"> • 13.56 MIFARE Classic • 8- and 10-Digit # Printed 	LTS MIFARE Key Fob	LTS MIFARE Thick Key Fob



Alarm Controls and Securiton Maglocks and Accessories

LTK-600S	LTK-1200S	LTK-600WP	LTK-1200WP	LTK-600D	LTK-1200D	LTK-AM3370	LTK-AM6370
							
<ul style="list-style-type: none"> • Alarm Controls Maglock • 600lb / 1,200lb Holding Force, UL294 and UL10C • Add AM3370 / 6370 if Door Opens Inwards 		<ul style="list-style-type: none"> • Alarm Controls Waterproof Maglock • 600lb / 1,200lb, Swinging or Sliding Gate • Add AM3370 / 6370 as Gate Bracket 		<ul style="list-style-type: none"> • Alarm Controls Double Door Maglock • 600lb / 1,200lb Holding Force, UL294 and UL10C • Add AM3375 / 6375 or 2 x AM3370 / 6370 if Door Opens Inwards 		<ul style="list-style-type: none"> • Alarm Controls LZ Bracket • For Mounting Maglocks onto Inward Swinging Doors • AM3370 for 600 Series and AM6370 for 1200 Series 	

Add Two Means of Egress to Your Maglock Installation

LTK-TS-2	LTK-TS-2-2	LTK-TS-2T	LTK-NTS-1	LTK-TS-14	LTK-TS-60	LTK-SREX-100	LTK-XMS	LTK-REB-1	
									
<ul style="list-style-type: none"> • Alarm Controls Green Push Button • 2" sq. Illuminated "Push to Exit," UL294 Listed • TS-2 is SPDT; TS-2-2 is DPDT; TS-2T is SPDT with 2 - 4 sec. Timer 		<ul style="list-style-type: none"> • Alarm Controls No Touch Sensor with 1 - 3 sec. Timer • Single Gang Stainless Steel Wall Plate, SPDT 		<ul style="list-style-type: none"> • Alarm Controls Pushbutton with 2 - 60 sec. Pneumatic Timer, UL294 Listed • 1.5" Large Green / 2.5" Extra Large Red Mushroom Button "Push To Exit", SPDT 		<ul style="list-style-type: none"> • Alarm Controls Focused RTE Motion Sensor • DPDT, UL294 Listed 		<ul style="list-style-type: none"> • Securiton Adjustable Pattern RTE Motion Sensor • NC only, UL294 Listed 	

Get a Certified Power Supply that Can Integrate with Fire Alarm Systems





LTK-AQD4-4C1R1	LTK-AQD6-8C8R2	LTK-AQL6-B100R8E1
		
12 or 24V DC 4A with 4 PTC Output		12 and 24V DC 6A with 8 Fuse Output
<ul style="list-style-type: none"> • Securiton AQ Series Power Supply with MagnaCare® Lifetime Replacement, No Fault Warranty • Protected Outputs with Alarm Interface, Cuts Off Power of Maglocks from the Source when Fire Alarm Triggered 		<ul style="list-style-type: none"> • UL294, UL603, ULC-S318, ULC-S533 Listed; RoHS Compliant and REACH Compliant



*All HES, Securiton, Adams Rite and Alarm Controls products are available to order through LTS.

*Batteries are NOT included for AQD Power Supplies.

Select Electrical Strikes According to Existing Door Hardware

Electrical Strike for Cylindrical Latch

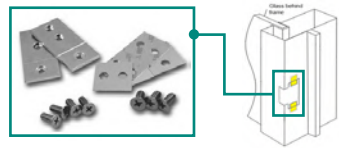
LTK-5000C-630	LTK-8000C-630	LTK-AES-300-12	LTK-AES-300-24
			
<ul style="list-style-type: none"> • HES 5000 Strike with 501 and 501A Faceplates • ANSI Metal Jamb or Aluminum Frames • Dual Voltage 12V DC / 24V AC, UL1034, UL294 Listed • Satin stainless steel 	<ul style="list-style-type: none"> • HES 8000 Strike with 801 and 801A Faceplates • Easy Installation with No Cutting on ANSI Frames • Dual Voltage 12V DC / 24V DC, UL1034, UL294 Listed • Satin stainless steel 	<ul style="list-style-type: none"> • AES-300 Strike with All Faceplates Included • Ultra Compact for Minimum Cutting on Wood Frames • 300-12 12V DC/AC; 300-24 24V DC/AC, UL1034 Listed 	

For Mortise Latch:	Mounting Tabs for Storefront	Change Deadbolt to Mortise Latch on Storefront	
LTK-1500C-630	LTK-152	LTK-4900-25-628	LTK-4900-26-628
			
<ul style="list-style-type: none"> • HES 1500 Strike with 1J, 1K, 1KD and 1KM Faceplates • Stainless Steel Construction with 10-Year No-Fault Warranty • Dual Voltage 12V DC / 24V DC, UL294, UL10C 3 Hours • Satin stainless steel 	<ul style="list-style-type: none"> • HES 152: Universal Mounting Tabs • Mount Inside Hollow Metal and Aluminum Jamb • Compatible with 5000, 8000, 7400, 1500, 1600 and More 	<ul style="list-style-type: none"> • Adams Rite Mortise Latch, Clear Anodized Finish • Drop-in Replacement for Many Deadbolt and Hook Bolt Locks • 31" / 32" Backset, -25 LH or RHR, -26 RH or LHR • Satin stainless steel 	

For RIM Exit Devices (Push Bar):

LTK-9400-630	LTK-9600-630	LTK-9500-630
		
<ul style="list-style-type: none"> • HES 9000 Series Slim-line Strike • Surface Mounted, No Cutting Needed • For 1/2" Pullman Latch • UL294 Listed • Satin stainless steel 	<ul style="list-style-type: none"> • HES 9000 Series Slim-line Strike • Surface Mounted, No Cutting Needed • For 3/4" Pullman Latch • UL294 Listed • Satin stainless steel 	<ul style="list-style-type: none"> • HES 9000 Series Slim-line Strike • Surface Mounted, No Cutting Needed • For 3/4" Pullman Latch • UL294, UL10C 3 Hours Fire Rated • Satin stainless steel

*All HES, Securitron, Adams Rite and Alarm Controls products are available to order through LTS. Please call sales for other HES finish colored models.

NVR

IP Cameras

DVR

TVI

Defendas

Intercom + AC

Accessories



airMAX[®]





SERVICE CODE :
UBNT-SERVICE

Accessories

*airMAX® setup service available for \$25 per unit

airMAX® Wireless **UniFi® Wifi**

LTU 5GHz							
	UBNT-LTU-LR 5 GHz PtMP LTU Long-Range Client, functions in a PtMP environment with the LTU-Rocket as the BaseStation.		UBNT-NSM5 Indoor/Outdoor airMAX 5GHz CPE.		UBNT-U7-PRO Ceiling-mounted WiFi 7 AP with 6 spatial streams and 6 GHz support for interference-free WiFi in demanding, large-scale environments.		UBNT-U6-IW Wall-mounted WiFi 6 AP with 6 spatial streams and a built-in 4-port switch ideal for single-room coverage in hospitality environments.
	UBNT-LTU-PRO 5 GHz PtMP LTU Client with advanced RF performance, functions in a PtMP environment with the LTU-Rocket as the BaseStation.		UBNT-LAP-120 Ultra-lightweight, 5GHz access point with a versatile, ball-joint mount		UBNT-U7-PRO-MAX NEW Ceiling-mounted WiFi 7 AP with 8 spatial streams, 6 GHz support, and a dedicated spectral scanning engine for interference-free WiFi in demanding, large-scale environments.		UBNT-U6-ENTERPRISE-IW Wall-mounted WiFi 6E AP with 10 spatial streams, 6 GHz support, and a built-in 4-port switch. Designed for high-density office networks.
	UBNT-LTU-ROCKET 5 GHz PtMP LTU BaseStation Radio, functions in a PtMP environment using the LTU Pro, LTU Lite, or LTU LR as Clients.		UBNT-NBE-5AC-GEN2 Compact, UISP-ready, 5GHz WiFi bridge with enhanced surge protection and an optimized radio and antenna.		UBNT-U7-OUTDOOR NEW All-weather WiFi 7 AP with 4 spatial streams, an integrated directional super antenna, and versatile mounting options.		UBNT-U6-LR Ceiling-mounted WiFi 6 AP with 8 spatial streams and extended signal range.
airMAX 5GHz			UBNT-IS-5AC Compact, UISP-ready, 5GHz WiFi bridge with enhanced surge protection and an interchangeable horn antenna.		UBNT-U7-PRO-WALL NEW Wall-mounted WiFi 7 AP with 6 spatial streams and 6 GHz support tailored for home builders with seamless installation options.		UBNT-U6-ENTERPRISE Ceiling-mounted WiFi 6E AP with 10 spatial streams and 6 GHz support to provide seamless, multi-band coverage within high client density environments.
	UBNT-LOC05AC Compact, UISP-ready WiFi radio sporting a classic NanoStation design and an updated airMAX AC chipset.		UBNT-R5AC-LITE airMAX AC Technology for up to 500+ Mbps throughput.		UBNT-U7-LITE NEW Wall-mounted WiFi 7 AP with 6 spatial streams and 6 GHz support tailored for home builders with seamless installation options.		UBNT-UAP-AC-M Compact, indoor/outdoor WiFi 5 AP with 4 spatial streams and optional external antenna support for directional coverage.
	UBNT-LBE-5AC-GEN2 Ultra-lightweight design with proprietary airMAX ac chipset and dedicated management WiFi for easy UISP mobile app support and fast setup.		UBNT-PBE-5AC-ISO-GEN2 5GHz WiFi bridge with a 450+ Mbps real TCP/IP throughput rate and enhanced surge protection.		UBNT-U7-IW NEW Wall-mounted WiFi 7 AP with 4 spatial streams and an integrated 2.5 GbE PoE switch designed for hospitality environments. Note. PoE+ input required for single-port PoE output.		UBNT-UAP-AC-PRO Ceiling-mounted WiFi 5 AP with 6 spatial streams designed for large offices.
	UBNT-LOCOM5 Low-cost and efficient broadband 5GHz CPE.		UBNT-RD-5G30 5 GHz, 30 dBi or 34 dBi high-performance dish antenna.		UBNT-U6+ Compact, ceiling-mounted WiFi 6 AP with 4 spatial streams that improves upon the U6 Lite with higher performance and dual-band WiFi 6 support. Ideal for small and medium-sized businesses.		UBNT-UAP-AC-HD Ceiling-mounted WiFi 5 AP with 8 spatial streams designed to support high-density networks and critical system applications.
	UBNT-NBE-M5-16 High-performance 5GHz, 16 dBi bridge.		UBNT-RP-5AC-GEN2 High-performance 5GHz basestation for PtMP or PtP links. Provides up to 500+ Mbps data throughput.		UBNT-U6-PRO Ceiling-mounted WiFi 6 AP with 6 spatial streams designed for large offices.		UBNT-UAP-AC-SHD Ceiling-mounted WiFi 5 AP with 8 spatial streams designed to support high client density environments.
Antennas and Accessories							
	UBNT-AMO-5G10 5 GHz, 10 dBi carrier-class 2x2 dual-polarity MIMO omnidirectional antenna.		UBNT-NS-WM Window mount for NanoStationM airMAX devices.		UBNT-U6-MESH Sleek, indoor/outdoor WiFi 6 AP with 6 spatial streams designed for mesh applications.		UBNT-UBB A 60 GHz wireless point-to-point bridge with 10G SFP+ uplink for maximum performance.
	UBNT-AMO-5G13 5 GHz, 13 dBi carrier-class 2x2 dual-polarity MIMO omnidirectional antenna.		UBNT-ACB-ISP Low-cost home WiFi access point made to interoperate with airMAX CPE devices, with remote management by UISP.		UBNT-U6-MESH-PRO Indoor/outdoor WiFi 6 AP with 4 spatial streams, an integrated super antenna, and a gigabit passthrough port.		UBNT-UBB-XG A 60 GHz wireless point-to-point bridge.
	UBNT-ETH-SP-G2 ESD protection for outdoor high-speed networks.		UBNT-ACB-AC High-performance home WiFi access point made to interoperate with airMAX CPE devices, with remote management by UISP.				
	UBNT-UB-AM Universal mounting bracket for wall-mount flexibility.						





*All Ubiquiti products are available to order through LTS

NVR | IP Cameras | DVR | TVI | Defendas | Intercom + AC | Accessories

UniFi® Cloud Gateways

	UBNT-UDM-PRO-MAX 10G Cloud Gateway with 200+ UniFi device / 2,000+ client support, 5 Gbps IPS routing, and redundant NVR storage.
	UBNT-UDM-PRO 10 Gbps Cloud Gateway with 100+ UniFi device / 1,000+ client support and 3.5 Gbps IPS routing.
	UBNT-UDM-SE 10 Gbps Cloud Gateway with 100+ UniFi device / 1,000+ client support, 3.5 Gbps IPS routing, and built-in PoE switching.
	UBNT-UX Impressively compact UniFi Cloud Gateway and WiFi 6 access point that runs UniFi Network. Powers an entire network or simply meshes as an access point.
	UBNT-UCG-MAX Compact 2.5G Cloud Gateway with 30+ UniFi device / 300+ client support, 2.3 Gbps IPS routing, and selectable NVR storage.
	UBNT-UCG-ULTRA Compact Cloud Gateway with 30+ UniFi device / 300+ client support, 1 Gbps IPS routing, and multi-WAN load balancing.









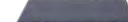

UniFi® CloudKeys Gateways

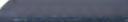
	UBNT-UXG-LITE A compact and powerful UniFi gateway with a full suite of advanced routing and security features.
	UBNT-UXG-PRO Multi-WAN independent gateway designed to protect large-scale networks with a full suite of advanced routing and security features.
	UBNT-UCK-G2-SSD  Compact UniFi Console that connects directly to the Site Manager at https://unifi.ui.com/ for powerful, multi-application site management. Pre-installed 1TB SSD

UniFi® PoE Switching

	UBNT-USW-ENTERPRISE-48-POE (720W) UBNT-USW-ENTERPRISE-24-POE (400W) UBNT-USW-ENTERPRISE-8-POE (120W) A 48 / 24 / 8-port, Layer 3 switch with 2.5 GbE PoE+ output.
	UBNT-USW-PRO-MAX-48-POE (720W) UBNT-USW-PRO-MAX-24-POE (400W) UBNT-USW-PRO-MAX-16-POE (180W) A 48 / 24 / 16-port, Layer 3 Etherlighting™ switch with 2.5 GbE and PoE++ output.
	UBNT-USW-PRO-48-POE (600W) UBNT-USW-PRO-24-POE (400W) UBNT-USW-PRO-8-POE (120W) A 48 / 24 / 8-port, Layer 3 switch capable of high-power PoE++ output.
	UBNT-USW-48-POE (195W) UBNT-USW-24-POE (95W) UBNT-USW-16-POE (42W) A 48 / 24 / 16-port, Layer 2 PoE switch with a silent, fanless cooling system.
	UBNT-USW-LITE-16-POE (45W) UBNT-USW-LITE-8-POE (52W) A wall-mountable, 16 / 8-port, Layer 2 PoE switch with a fanless cooling system.
	UBNT-USW-FLEX (46W) Flexible 5-port, Layer 2 PoE switch for indoor and outdoor use, that can be powered with PoE++.
	UBNT-USW-FLEX-MINI A compact, 5-port, Layer 2 switch that can be powered with PoE or a 5V USB-C adapter.
	UBNT-USW-FLEX-UTILITY The Switch Flex Utility is an outdoor weatherproof enclosure designed for use with the Switch Flex.













Managed PoE Switches

























	POE-SWC402G  4-Port Cloud Managed Gigabit PoE Switch 	<ul style="list-style-type: none"> • 60 W, IEEE 802.3af/at • 4 x Gigabit PoE RJ45 ports • Up to 1,000 ft • 2 x Gigabit RJ45 port • Supports LTS Platinum Partner (LPP)
	POE-SWC802G  8-Port Cloud Managed Gigabit PoE Switch 	<ul style="list-style-type: none"> • 110 W, IEEE 802.3af/at • 8 x Gigabit PoE RJ45 ports • Up to 1,000 ft • 2 x Gigabit RJ45 port • Supports LTS Platinum Partner (LPP)
	POE-SWC1601G  16-Port Cloud Managed Gigabit PoE Switch 	<ul style="list-style-type: none"> • 230 W, IEEE 802.3af/at • 16 x Gigabit PoE RJ45 ports • Up to 1,000 ft • 1 x Gigabit RJ45 port • 1 x Gigabit fiber optical port • Supports LTS Platinum Partner (LPP)
	POE-SWC2401G  24-Port Cloud Managed Gigabit PoE Switch 	<ul style="list-style-type: none"> • 370 W, IEEE 802.3af/at • 24 x Gigabit PoE RJ45 ports • Up to 1,000 ft • 1 x Gigabit RJ45 port • 1 x Gigabit fiber optical port • Supports LTS Platinum Partner (LPP)

Wireless Bridges

















	LTWB-5AC-12 12V DC Wireless Bridge (Up to 3 Miles)
	LTWB-5AC-360 360° PoE Wireless Bridge receiver with antenna (Up to 1 mile)

*All Ubiquiti products are available to order through LTS





Power Adapters			Power Supplies			Warning Signs		
PS120V0800	800mA, 12V DC		12V DC		Rating			
PS120V1000	1000mA, 12V DC		PS120V5-D	• 4 Ports • 5 Amps	PTC			LTSIGNB • 9"(W) x 11"(H)
PS120V2000	2000mA, 12V DC		DV-AT1207M-D09	• 9 Ports • 7 Amps	PTC			LTSIGNA • 11"(W) x 18"(H)
PS120V3000	3000mA, 12V DC		DV-AT1209A-D9P	• 9 Ports • 9 Amps	PTC			LTSACS-801 • Solar Power (No Battery Needed) • Actively Flashing LCD
TS5-6W	5000mA, 12V DC		DV-AT1212A-D18P	• 18 Ports • 12 Amps	PTC		Monitor Brackets	
PS240V1000	1000mA, 24V AC		DV-AT1220A-D18P	• 18 Ports • 20 Amps	PTC			LTMB1026 • For 10" - 26" Screen Size • Distance to Wall 35 - 390 mm • Max load: 10 kg
PS240V3000	3000mA, 24V AC		DV-RT1224A-D24	• 24 Ports • 24 Amps	PTC			LTMB1737 • For 17" - 37" Screen Size • Distance to Wall 35 - 380 mm • Max load: 30kg
DV-AT12015-D01	1500mA (Max), 24V AC to 12V DC		DV-RT1232A-D32	• 32 Ports • 32 Amps	PTC			LTMB2655 • For 26" - 55" Screen Size • Distance to Wall 7 mm • Max load: 50kg
Passive Video Balun Tranceivers			DV-AT1205A-D07	• 4 Ports • 5 Amps	PTC			LTMB3270 • For 32" - 70" Screen Size • Distance to Wall 70 - 390 mm • Max load: 75kg
	<ul style="list-style-type: none"> • 8 MP/4K Passive HD Video Balun • Compatible with HD-TVI / CVI / AHD / CVBS Cameras • Support 720p / 960p / 1080p / 3 MP / 5 MP / 8 MP 		DV-AT1209A-D9	• 9 Ports • 9 Amps	Fuse			
			DV-AT1212A-D18	• 18 Ports • 12 Amps	Fuse			
LTAB4030TP			DV-AT1210A-D07 	• 9 Ports • 10 Amps	Fuse			
DVR Lockboxes			DV-AT1210A-D10 	• 18 Ports • 10 Amps	Fuse			
	LT-DVRLB18-18-5		DV-AT1215A-D10 	• 18 Ports • 18 Amps	Fuse			
	LT-DVRLB21-21-8		DV-AT1232A-D18	• 18 Ports • 32 Amps	Fuse			
	LT-DVRLB21-24-8		DV-AT1232A-D27	• 27 Port • 32 Amp	Fuse			
	LTBHWB (Wall Mount Bracket)		24V AC		Rating			
			DV-AC2408A-D07	• 9 Port • 8 Amp	PTC			
			DV-AC2412A-D10	• 18 Ports • 12 Amps	PTC			

Connectors			Control Cables		
	LTA1001	BNC Twist-On RG59 Male (20 pcs/pack)		 LTAC1802G-CMR	<ul style="list-style-type: none"> • 18AWG / 2 Conductor Access Control Wire • 1000 ft Stranded • 99.99% OFC • Access Control, Intercom, and Alarm • CMR Rated, UL Listed • Color: Gray
	LTA1002	BNC Male to RCA Female (20 pcs/pack)		 LTAC1806G-CMR	<ul style="list-style-type: none"> • 18AWG / 6 Conductor Control Wire • 500 ft Stranded • 99.99% OFC • CMR Rated • Shielded ETL • Color: Gray
	LTA1003	BNC Female to RCA Male (20 pcs/pack)		 LTAC1822Y-CMR	<ul style="list-style-type: none"> • 500 ft Stranded Control Cable • 99.99% OFC • 18/4 + 22/2 + 22/4 + 22/6 Combination Cable • Shielded 22/6 • ETL Rated, CMR Rated • Color: Yellow
	LTA1004	BNC Male to RCA Male (20 pcs/pack)	Cables (HDMI, DC Power, X RJ45)		
	LTA1005	BNC Coupler Female to Female (20 pcs/pack)		LTAC3005 LTAC3110 LTAC3125 LTAC3150	<ul style="list-style-type: none"> • HDMI with Ethernet • 4.5 / 10 / 25 / 50 ft Cable • Hi-Speed 1080p / 3D, 100% Triple Shield 24K • Gold Plated with Nylon Jacket
	LTA1006	BNC Compression for RG59 (20 pcs/pack)		LTAC3100 LTAC31120	<ul style="list-style-type: none"> • 100 ft HDMI Cable • Hi-Speed 1080p with USB Booster 26AWG
	LTA1007	BNC Male Crimp-on (20 pcs/pack)		LTA2003	<ul style="list-style-type: none"> • Terminal Connector • 9 Terminal, DC & AC • Connector / Splitter
	LTA1013	BNC Male to 2 BNC Female (20 pcs/pack)		LTA2017 LTA2013	<ul style="list-style-type: none"> • DC Power Connector • LTA2017 - Male • LTA2013 - Female (20 pcs/pack)
	LTA1014	X RJ45 8P8C Cat5e Crimp Connector		LTA2004 LTA2014	<ul style="list-style-type: none"> • DC Power Adapter Cable • LTA2004 - Male • LTA2014 - Female (20 pcs/pack)
	LTA1016	X RJ45 8P8C Cat6 Crimp Connector		LTA2010 LTA2008	<ul style="list-style-type: none"> • Male / Female Pigtail • LTA2010 - Male • LTA2008 - Female
	LT-KY5E110	Enhanced Cat5e Keystone Jack	CAT5e Pre-Made Cables		
	LTAC2041	<ul style="list-style-type: none"> • Pre-made RJ45 CAT5e Cable • LTAC2041 - 100 ft 	Tools		
	LTA-T203MS	<ul style="list-style-type: none"> • Wire Stripper • Strip Wire (12 - 22 gauge) with One Pull of Trigger • Built-in Ruler Splicer with Auto Adjust 			

Cables (Coaxial, CAT5e and CAT6 Network)

	LTAC5100W-CMR LTAC5100BL-CMR LTAC5100B-CMR	 	<ul style="list-style-type: none"> • 1,000 ft CAT5e 99.99% OFC • UL Listed or ETL Listed, RoHS Compliant • ISO / IEC11801, ANSI / TIA-568B-C.2 • Fluke Tested • CMR Rated • Color: White / Blue / Black
	LTAC6250W-CMR LTAC6250BL-CMR LTAC6250B-CMR	 	<ul style="list-style-type: none"> • 1,000 ft CAT6 99.99% OFC • UL Listed or ETL Listed, RoHS Compliant • ISO / IEC11801, ANSI / TIA-568B-C.2 • Fluke Tested • CMR Rated • Color: White / Blue / Black / Gray / Orange
	LTAC5100B-CMX LTAC6250B-CMX	 	<ul style="list-style-type: none"> • 1,000 ft CAT5e / CAT6 99.99% OFC • ETL Listed, RoHS Compliant • ISO / IEC11801, ANSI / TIA-568B-C.2 • Fluke Tested • Outdoor Rated, UV Resistance • Direct Burial • Color: Black
	LTAC6250W-CMP LTAC6250BL-CMP LTAC6250B-CMP		<ul style="list-style-type: none"> • 1,000 ft CAT6 99.99% OFC • UL Listed, RoHS Compliant • ISO / IEC11801, TIA-568-C.2 • Fluke Tested • Plenum Rated, CMP • Color: White / Blue / Black
	LTAC2040 LTAC2046		<ul style="list-style-type: none"> • 1,000 ft CCA CAT5e / CAT6 • Commercial Grade Network Cable • Color: White / Blue / Black
	LTAC2031W / LTAC2031B LTAC2033W / LTAC2033B		<ul style="list-style-type: none"> • Siamese Coaxial Cable • White / Black Bare Wire • 500 ft / 1,000 ft RG59, Coaxial 95%, Braided + 18/2 • 18AWG CCA Cable
	LTAC2030 LTAC2032		<ul style="list-style-type: none"> • Siamese Coaxial Cable • White / Black Bare Wire • 500 ft / 1,000 ft RG59, Coaxial 95%, Braided + 18/2 • Solid 100% 18AWG Oxygen Free Copper
	LTAC2030B-CMX LTAC2032B-CMX		<ul style="list-style-type: none"> • Siamese Coaxial Cable • Color: Black • Direct Burial • 500 ft / 1,000 ft RG59, Coaxial 95%, Braided + 18/2 • Solid 100% 18AWG Oxygen Free Copper
	LTAC2050W / LTAC2050B LTAC2075W / LTAC2075B LTAC2100W / LTAC2100B LTAC2125W / LTAC2125B		<ul style="list-style-type: none"> • Pre-made HD Siamese Cable with BNC and Power Connector • 50 ft / 75 ft / 100 ft / 125 ft • Color: White / Black

























Cables (DC Power, VGA, Microphone)

	LTA2005	<ul style="list-style-type: none"> • DC Power Splitter • 1 Female to 2 Male
	LTA2006	<ul style="list-style-type: none"> • DC Power Splitter • 1 Male to 2 Female
	LTA2011	<ul style="list-style-type: none"> • DC Power Splitter • 1 Female to 4 Male
	LTA2018	<ul style="list-style-type: none"> • DC Power Splitter • 1 Female to 8 Male
	LTA2001	<ul style="list-style-type: none"> • 12" Microphone with Power Cable • Microphone with Amplifier

Converters, Splitters, Extenders

	LTAH2100E	<ul style="list-style-type: none"> • USB RJ45 Extender • 2 x USB, USB A Female • Plug & Play • Cable Type: CAT5, 5E, 6, UTP • Extend Distance to 150 ft
	LTAH014LN	<ul style="list-style-type: none"> • 1 in / 4 out HDMI Splitter • Support HDMI 1.3 and 1080p • HDCP & 3D Support
	LTAH018L	<ul style="list-style-type: none"> • 1 in / 8 out HDMI Splitter • 8 Identical HDMI Outputs • Up to 225MHz • Support 3D
	LTAH3100E	<ul style="list-style-type: none"> • VGA / Audio X RJ45 Extender • Video Type: VGA • Supports 1920 x 1440 • 1 x Stereo Audio (R/L) • Extend Distance to 900 ft
	LTAH1070E	<ul style="list-style-type: none"> • HDMI Extender 1080p • Supports 1080p up to 165 ft • 5V DC/1A, Power Adapter included
	LTAH5300T	<ul style="list-style-type: none"> • HD-TVI Distributor • Input: 1 x HD-TVI • Output: 3 x HD-TVI

IDEAL Tools and Connectors | **Power Strips and Extension Cords**

	IDEAL-85-372E IDEAL-85-377E	CAT5e / CAT6 Feed-Thru Modular Plugs			LTPE1610 LTPE1625 LTPE1650 LTPE16100		<ul style="list-style-type: none"> • 10/25/50/100 ft, 16/3C SJTW Extension Cord • Orange Single Outlet, UL Listed 	
	IDEAL-30-495	FT-45™ Feed-Thru Modular Plug Crimp Tool Crimps Feed-Thru, Standard and Shielded			LTPE1225-L3 LTPE1250-L3 LTPE12100-L3		<ul style="list-style-type: none"> • 25/50/100 ft, 12/3C SJTW Extension Cord • Yellow 6 ft Cord, Triple Outlet • Lighted when Power is On, UL Listed 	
	IDEAL-35-088	Snips with Stripping Notch			LTPE1420-3		<ul style="list-style-type: none"> • 20 ft 14/3C Indoor Extension Cord • Orange Cord, Triple Outlet with Sliding Cover Feature, UL Listed 	
	IDEAL-45-074	Data T®-Cutter			LTPS0806 LTPS0812		<ul style="list-style-type: none"> • 8 Outlet Power Strips • White, 2 / 6 / 12 ft Cord, UL Listed 	
	IDEAL-89-1047E	InSITE™ RG-59 BNC Compression Connectors Window Ensures Proper Cable Insertion			LTPS0606-M		<ul style="list-style-type: none"> • 6 Outlet Metal Case Outlet Strips • Yellow, 6 ft Cord, ETL Listed 	
	IDEAL-30-793	OmniSeal™ PRO XL Compression Tool			LTPS0806-M		<ul style="list-style-type: none"> • 8 Outlet Metal Case Outlet Strips • Yellow, 6 ft Cord, UL Listed 	
	IDEAL-33-632	LinearX®3 Compression Tool			LTPS0806-A		<ul style="list-style-type: none"> • 8 Way Aluminum Alloy Case Power Bar • 6 ft Cord, ETL Listed 	
	IDEAL-45-605	PrepPRO® Coax/UTP Cable Stripper			LTPS1215-A		<ul style="list-style-type: none"> • 12 Way Aluminum Alloy Case Power Bar • 15 ft Cord, ETL Listed 	

WD Purple and Purple Pro HDDs



	Capacity	1TB, 2TB, 3TB, 4TB, 6TB, 8TB		Capacity	8TB, 10TB, 12TB, 14TB, 18TB, 22TB, 24TB, 26TB
	Interface	SATA 6 Gb/s		Interface	SATA 6 Gb/s
	Form Factor	3.5 inch		Form Factor	3.5 inch
	MTBF	Up to 1 million hours		MTBF	Up to 2.5 million hours
	Warranty	3 years		Warranty	5 years
	<ul style="list-style-type: none"> • Engineered for mainstream surveillance security systems • AllFrame™ technology improves ATA streaming to help reduce frame loss and improve overall video playback • Supports up to 64 single-stream cameras per drive • Supports Western Digital Device Analytics™ (WDDA) • Workload rating up to 180TB year, 3x the rating of desktop drive 			<ul style="list-style-type: none"> • Higher Capacity Drives for More Demanding Smart Video Solutions • Enterprise Class Reliability • High Performance for Simultaneous Video Recording and Real-Time AI Analysis • Built for Advanced Smart Video Workloads • Innovative AllFrame™ Technology • Proactive Drive Health Insights with WDDA™ 	



Western Digital.

UNSTOPPABLE PURSUIT

For a Safer Future

Celebrating
10 Years of
WD Purple®

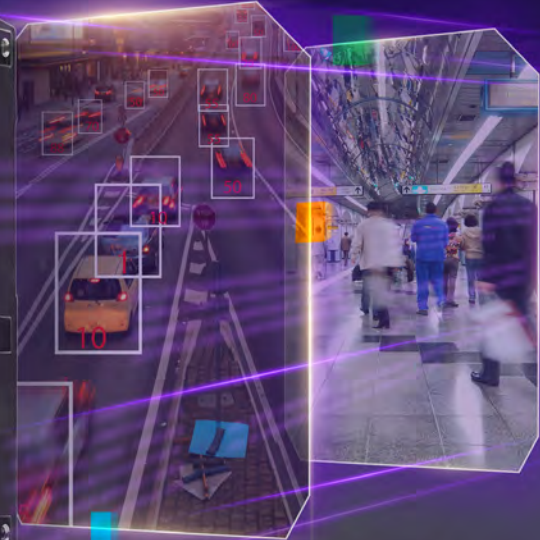

Since 2009

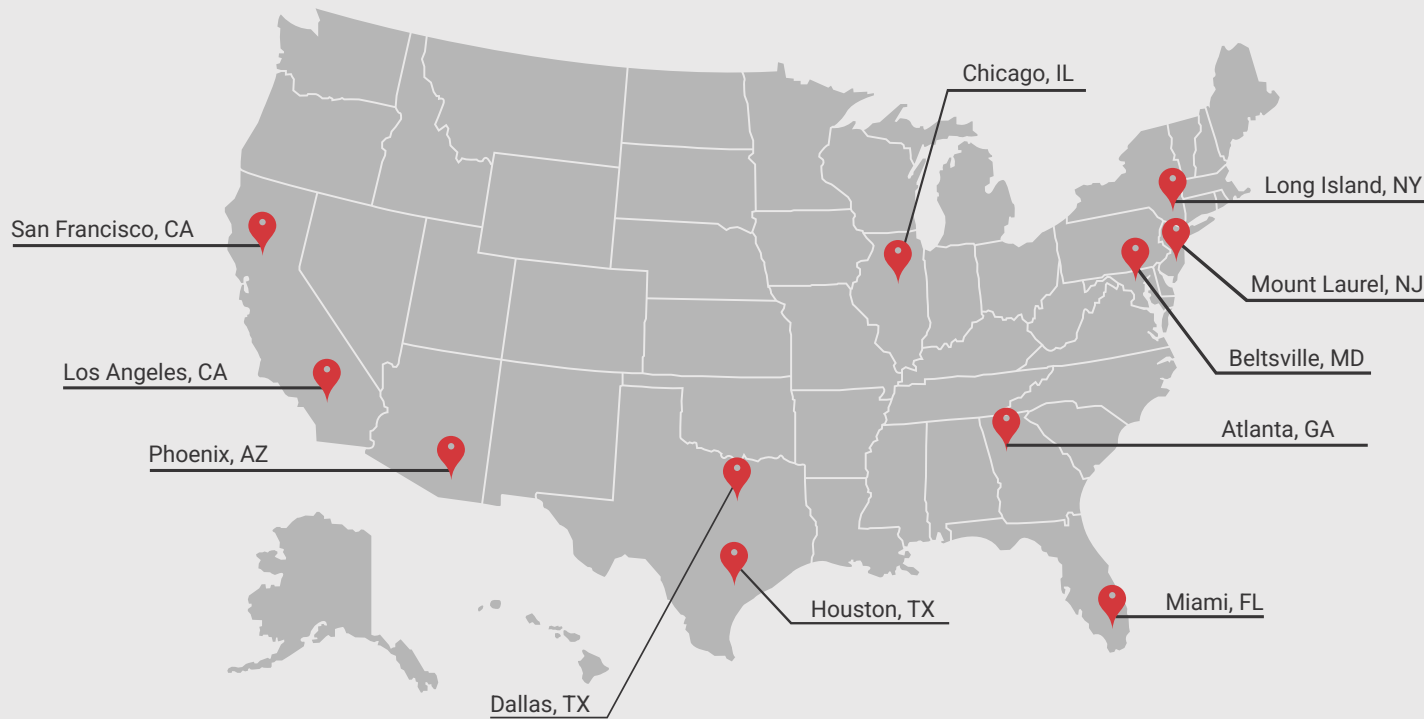

Visit
LTSecurityinc.com

West Region

California - Los Angeles

17333 Freedom Way
City of Industry, CA 91748
Toll Free: 888-587-5871
Tel: 626-435-2838
Email: Contact.LosAngeles@LTSecurityinc.com
Sales Office: 8:30am - 6pm (PST): MON - FRI
En LTS California hablamos español

California - San Francisco

37370 Cedar Blvd., Suite D
Newark, CA 94560
Toll Free: 888-216-2812
Tel: 510-201-9868
Email: Support.SanFrancisco@LTSecurityinc.com
Sales Office: 9am - 6pm (PST): MON - FRI
**Effective December 2025*

Arizona - Phoenix

2850 S. 36th St., Suite A-7
Phoenix, AZ 85034
Toll Free: 877-284-2890
Tel: 602-903-2220
Email: Support.AZ@LTSecurityinc.com
Sales Office: 8:30am - 5:30pm (MST): MON - FRI
En LTS Arizona hablamos español

Central Region

Texas - Houston

8634 Westpark Dr.
Houston, TX 77063
Tel: 713-587-1800
Email: Support.Houston@LTSecurityinc.com
Sales Office: 8:30am - 6pm (CST): MON - FRI
En LTS Houston hablamos español

Texas - Dallas

1100 Valwood Pkwy., Suite 112
Carrollton, TX 75006
Tel: 469-289-5780
Email: Support.Dallas@LTSecurityinc.com
Sales Office: 8:30am - 5:30pm (CST): MON - FRI
En LTS Dallas hablamos español

Illinois - Chicago

1951 Landmeier Rd.
Eik Grove Village, IL 60007
Tel: 630-348-8088
Email: Support.Chicago@LTSecurityinc.com
Sales Office: 9am - 6pm (CST): MON - FRI
En LTS Illinois hablamos español

East Region

New Jersey - Mount Laurel

109 West Park Dr., Suite B & C
Mount Laurel, NJ 08054
Toll Free: 855-835-8889
Tel: 856-780-9888
Email: Support.NewJersey@LTSecurityinc.com
Sales Office: 8:30am - 6pm (EST): MON - FRI

New York - Long Island

454 W John St
Hicksville, NY 11801
Toll Free: 888-517-3102
Tel: 646-555-3888
Email: Support.NewYork@LTSecurityinc.com
Sales Office: 8:30am - 5:30pm (EST): MON - FRI
After-hour Pickup Available

Maryland - Beltsville

7001 Muirkirk Meadows Dr., Suite A
Beltsville, MD 20705
Tel: 240-493-8988
Email: Support.Maryland@LTSecurityinc.com
Sales Office: 8:30am - 5:30pm (EST): MON - FRI
En LTS Maryland hablamos español

Georgia - Atlanta

5933 Peachtree Industrial Blvd., Suite B
Norcross, GA 30092
Tel: 678-710-3788
Email: Support.GA@LTSecurityinc.com
Sales Office: 8:30am - 5:30pm (EST): MON - FRI

Florida - Miami

1609 NW 84th Ave
Doral, FL 33126
Tel: 786-693-1813
Fax: 786-631-3639
Email: Support.Florida@LTSecurityinc.com
Sales Office: 8:30am - 5:30pm (EST): MON - FRI
En LTS Florida hablamos español