

Network Video Recorder

User Manual

Legal Information

About this Document

- This Document includes instructions for using and managing the Product. Pictures, charts, images and all other information hereinafter are for description and explanation only.
- The information contained in the Document is subject to change, without notice, due to firmware updates or other reasons. Please find the latest version of the Document at the company website. Unless otherwise agreed, our company makes no warranties, express or implied.
- Please use the Document with the guidance and assistance of professionals trained in supporting the Product.

About this Product

This product can only enjoy the after-sales service support in the country or region where the purchase is made.

Trademarks Acknowledgment

All trademarks and logos mentioned are the properties of their respective owners.

LEGAL DISCLAIMER

- TO THE MAXIMUM EXTENT PERMITTED BY APPLICABLE LAW, THIS DOCUMENT AND THE PRODUCT DESCRIBED, WITH ITS HARDWARE, SOFTWARE AND FIRMWARE, ARE PROVIDED "AS IS" AND "WITH ALL FAULTS AND ERRORS". OUR COMPANY MAKES NO WARRANTIES, EXPRESS OR IMPLIED, INCLUDING WITHOUT LIMITATION, MERCHANTABILITY, SATISFACTORY QUALITY, OR FITNESS FOR A PARTICULAR PURPOSE. THE USE OF THE PRODUCT BY YOU IS AT YOUR OWN RISK. IN NO EVENT WILL OUR COMPANY BE LIABLE TO YOU FOR ANY SPECIAL, CONSEQUENTIAL, INCIDENTAL, OR INDIRECT DAMAGES, INCLUDING, AMONG OTHERS, DAMAGES FOR LOSS OF BUSINESS PROFITS, BUSINESS INTERRUPTION, OR LOSS OF DATA, CORRUPTION OF SYSTEMS, OR LOSS OF DOCUMENTATION, WHETHER BASED ON BREACH OF CONTRACT, TORT (INCLUDING NEGLIGENCE), PRODUCT LIABILITY, OR OTHERWISE, IN CONNECTION WITH THE USE OF THE PRODUCT, EVEN IF OUR COMPANY HAS BEEN ADVISED OF THE POSSIBILITY OF SUCH DAMAGES OR LOSS.
- YOU ACKNOWLEDGE THAT THE NATURE OF THE INTERNET PROVIDES FOR INHERENT SECURITY RISKS, AND OUR COMPANY SHALL NOT TAKE ANY RESPONSIBILITIES FOR ABNORMAL OPERATION, PRIVACY LEAKAGE OR OTHER DAMAGES RESULTING FROM CYBER-ATTACK, HACKER ATTACK, VIRUS INFECTION, OR OTHER INTERNET SECURITY RISKS; HOWEVER, OUR COMPANY WILL PROVIDE TIMELY TECHNICAL SUPPORT IF REQUIRED.
- YOU AGREE TO USE THIS PRODUCT IN COMPLIANCE WITH ALL APPLICABLE LAWS, AND YOU ARE SOLELY RESPONSIBLE FOR ENSURING THAT YOUR USE CONFORMS TO THE APPLICABLE LAW. ESPECIALLY, YOU ARE RESPONSIBLE, FOR USING THIS PRODUCT IN A MANNER THAT DOES NOT INFRINGE ON THE RIGHTS OF THIRD PARTIES, INCLUDING WITHOUT LIMITATION, RIGHTS OF PUBLICITY, INTELLECTUAL PROPERTY RIGHTS, OR DATA PROTECTION AND OTHER PRIVACY

RIGHTS. YOU SHALL NOT USE THIS PRODUCT FOR ANY PROHIBITED END-USES, INCLUDING THE DEVELOPMENT OR PRODUCTION OF WEAPONS OF MASS DESTRUCTION, THE DEVELOPMENT OR PRODUCTION OF CHEMICAL OR BIOLOGICAL WEAPONS, ANY ACTIVITIES IN THE CONTEXT RELATED TO ANY NUCLEAR EXPLOSIVE OR UNSAFE NUCLEAR FUEL-CYCLE, OR IN SUPPORT OF HUMAN RIGHTS ABUSES.

- IN THE EVENT OF ANY CONFLICTS BETWEEN THIS DOCUMENT AND THE APPLICABLE LAW, THE LATTER PREVAILS.

Regulatory Information

FCC Information

Please take attention that changes or modification not expressly approved by the party responsible for compliance could void the user's authority to operate the equipment.

FCC compliance: This equipment has been tested and found to comply with the limits for pursuant to part 15 of the FCC Rules. These limits are designed to provide reasonable protection against harmful interference in a residential installation. This equipment generates, uses and can radiate radio frequency energy and, if not installed and used in accordance with the instructions, may cause harmful interference to radio communications. However, there is no guarantee that interference will not occur in a particular installation. If this equipment does cause harmful interference to radio or television reception, which can be determined by turning the equipment off and on, the user is encouraged to try to correct the interference by one or more of the following measures:

- Reorient or relocate the receiving antenna.
- Increase the separation between the equipment and receiver.
- Connect the equipment into an outlet on a circuit different from that to which the receiver is connected.
- Consult the dealer or an experienced radio/TV technician for help.

FCC Conditions

This device complies with part 15 of the FCC Rules. Operation is subject to the following two conditions:

- This device may not cause harmful interference.
- This device must accept any interference received, including interference that may cause undesired operation.

EU Conformity Statement



This product and - if applicable - the supplied accessories too are marked with "CE" and comply therefore with the applicable harmonized European standards listed under the EMC Directive 2014/30/EU, LVD Directive 2014/35/EU, the RoHS Directive 2011/65/EU.



2012/19/EU (WEEE directive): Products marked with this symbol cannot be disposed of as unsorted municipal waste in the European Union. For proper recycling, return this product to your local supplier upon the purchase of equivalent new equipment, or dispose of it at designated collection points. For more information see:

<http://www.recyclethis.info>.





Regulation (EU) 2023/1542(Battery Regulation): This product contains a battery and it is in conformity with the Regulation (EU) 2023/1542. The battery cannot be disposed of as unsorted municipal waste in the European Union. See the product documentation for specific battery information. The battery is marked with this symbol, which may include lettering to indicate cadmium (Cd), or lead (Pb). For proper recycling, return the battery to your supplier or to a designated collection point. For more information see: <http://www.recyclethis.info>.

Safety Instruction

- Proper configuration of all passwords and other security settings is the responsibility of the installer and/or end-user.
- In the use of the product, you must be in strict compliance with the electrical safety regulations of the nation and region.
- Firmly connect the plug to the power socket. Do not connect several devices to one power adapter. Power off the device before connecting and disconnecting accessories and peripherals.
- Shock hazard! Disconnect all power sources before maintenance.
- The equipment must be connected to an earthed mains socket-outlet.
- The socket-outlet shall be installed near the device and shall be easily accessible.
- For the device with the sign ⚡ indicating hazardous live, the external wiring connected to the terminals requires installation by an instructed person.
- Never place the device in an unstable location. The device may fall, causing serious personal injury or death.
- Input voltage should meet the SELV (Safety Extra Low Voltage) and the LPS (Limited Power Source) according to the IEC62368.
- High touch current! Connect to earth before connecting to the power supply.
- If smoke, odor or noise rise from the device, turn off the power at once and unplug the power cable, and then please contact the service center.
- Use the device in conjunction with an UPS, and use factory recommended HDD if possible.
- This equipment is not suitable for use in locations where children are likely to be present.
- CAUTION: Risk of explosion if the battery is replaced by an incorrect type.
- Do not ingest battery. Chemical Burn Hazard!
- This product contains a coin/button cell battery. If the coin/button cell battery is swallowed, it can cause severe internal burns in just 2 hours and can lead to death.
- Improper replacement of the battery with an incorrect type may defeat a safeguard (for example, in the case of some lithium battery types).
- Do not dispose of the battery into fire or a hot oven, or mechanically crush or cut the battery, which may result in an explosion.
- Do not leave the battery in an extremely high temperature surrounding environment, which may result in an explosion or the leakage of flammable liquid or gas.
- Do not subject the battery to extremely low air pressure, which may result in an explosion or the leakage of flammable liquid or gas.
- Dispose of used batteries according to the instructions.
- Keep body parts away from fan blades and motors. Disconnect the power source during servicing.
- Keep body parts away from motors. Disconnect the power source during servicing.
- Use only power supplies same with the original model, or LPS power supplies with the same voltage and electric current.

Preventive and Cautionary Tips

Before connecting and operating your device, please be advised of the following tips:

- The device is designed for indoor use only. Install it in a well-ventilated, dust-free environment without liquids.
- Ensure recorder is properly secured to a rack or shelf. Major shocks or jolts to the recorder as a result of dropping it may cause damage to the sensitive electronics within the recorder.
- The device shall not be exposed to water dripping or splashing, and no objects filled with liquids, such as vases, shall be placed on the device.
- No naked flame sources, such as lighted candles, should be placed on the device.
- The ventilation should not be impeded by covering the ventilation openings with items, such as newspapers, table-cloths, curtains. The openings shall never be blocked by placing the device on a bed, sofa, rug, or other similar surface.
- For certain models, ensure correct wiring of the terminals for connection to an AC mains supply.
- For certain models, the equipment has been designed, when required, modified for connection to an IT power distribution system.
-  identifies the battery holder itself and identifies the positioning of the cell(s) inside the battery holder.
- + identifies the positive terminal(s) of the device which is used with, or generates direct current, and - identifies the negative terminal(s) of the device which is used with, or generates direct current.
- If the device has been powered off or placed for a long time, its coin/button cell battery may run out power.
- When the coin/button cell battery runs out power, the system time would be incorrect, please contact the after-sales service to replace the battery.
- Keep a minimum 200 mm (7.87 inch) distance around the equipment for sufficient ventilation.
- For certain models, ensure correct wiring of the terminals for connection to an AC mains supply.
- Do not touch the sharp edges or corners.
- When the device is running above 45 °C (113 °F), or its HDD temperature in S.M.A.R.T. exceeds the stated value, please ensure the device is running in a cool environment, or replace HDD(s) to make the HDD temperature in S.M.A.R.T. below the stated value.
- Provide a surge suppressor at the inlet opening of the device under special conditions such as the mountain top, iron tower, and forest.
- Do not touch the bare components (such as the metal contacts of the inlets) and wait for at least 5 minutes, since electricity may still exist after the device is powered off.
- The USB port of the equipment is used for connecting to a mouse, keyboard, USB flash drive, or Wi-Fi dongle only. The current for the connected device shall be not more than 0.1 A.
- The serial port of the device is used for debugging only.
- If the power output port of the device does not comply with Limited Power Source, the connected device powered by this port shall be equipped with a fire enclosure.
- If a power adapter is provided in the device package, use the provided adapter only.
- For the device with sticker  or , pay attention to the following cautions: CAUTION: Hot

parts! Do not touch. Burned fingers when handling the parts. Wait one-half hour after switching off before handling the parts.

- If the device needs to be installed on the wall or ceiling, install the device according to the instructions in this manual.
- To prevent injury, this device must be securely attached to the installation surface in accordance with the installation instructions.
-
- Under high working temperature (40 °C (104 °F) to 55 °C (131 °F)), the power of some power adapters may decrease.
- Make sure that the power has been disconnected before you wire, install, or disassemble the device.
- If the device needs to be wired by yourself, select the corresponding wire to supply power according to the electric parameters labeled on the device. Strip off wire with a standard wire stripper at corresponding position. To avoid serious consequences, the length of stripped wire shall be appropriate, and conductors shall not be exposed.
- If smoke, odor, or noise arises from the device, immediately turn off the power, unplug the power cable, and contact the service center.



Content Convention

In order to simplify description, please read the following conventions.

- Recorder or device mainly refers to video recorder.
- IP device mainly refers to network camera (IP camera), IP dome (speed dome), DVS (Digital Video Server), or NVS (Network Video Server).
- Channel mainly refers to the video channel in video recorder.

Symbol Conventions

The symbols that may be found in this document are defined as follows.



| Symbol | Description |
|--|---|
|  Danger | Indicates a hazardous situation which, if not avoided, will or could result in death or serious injury. |
|  Caution | Indicates a potentially hazardous situation which, if not avoided, could result in equipment damage, data loss, performance degradation, or unexpected results. |
|  Note | Provides additional information to emphasize or supplement important points of the main text. |

Indicator and Interface Description

Front Panel Indicator Description

The indicators at the front panel indicates different working status of your device.

Table 1-1 Common Indicator Description

| Indicator | Description |
|---|--|
|  | The indicator turns on when device is powered up. |
|  | The indicator flashes when data is being read from or written to HDD. |
|  | The indicator flashes when network connection is functioning properly. |

Interface Description

The panel interfaces vary with different models. Refer to the following table for common interface description.

Table 1-2 Common Indicator Description

| Item | Description |
|-----------|---|
| VIDEO IN | BNC interface for Turbo HD and analog video input. |
| VIDEO OUT | BNC connector for video output. |
| AUDIO IN | RCA connector for audio input. |
| AUDIO OUT | RCA connector for audio output. |
| LINE IN | RCA connector for two-way audio input. |
| USB | Universal Serial Bus (USB) interface for additional device. |
| VGA | DB15 connector for local video output and menu display. |
| HDMI | HDMI interface for video output. |
| RS-485 | RS-485 serial interface for pan/tilt unit, speed dome, etc. |
| RS-232 | RS-232 interface for parameter configuration, or transparent channel. |
| LAN | RJ-45 self-adaptive Ethernet interface. |
| eSATA | Storage and expansion interface for record or backup. |
| GND | Ground. |

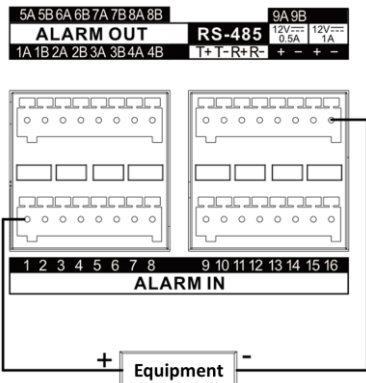
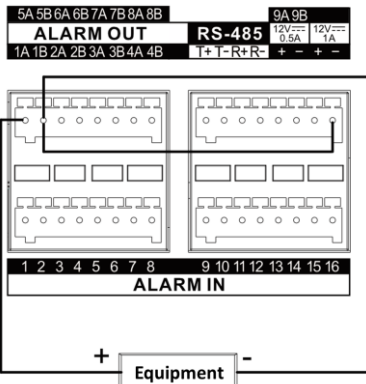
| Item | Description |
|---|---|
| Power Switch | Switch for turning on/off the device. |
| Power Supply | 100 to 240 VAC, 48 VDC, or 12 VDC power supply. |
| USIM Card | UIM/SIM card slot. |
|  | SMA antenna interface. |
| ALARM IN | <p>The alarm input receives alarm input signal. The equipment positive terminal (+) should connect to a number, and the equipment negative terminal (-) should connect to “-” or “G”.</p> <p>Use the following diagram as a connection example for alarm input.</p>  |
| ALARM OUT | <p>The alarm output sends out alarm signal.</p> <p>When an equipment uses DC power supply, its positive terminal (+) should connect to a number with “A”, and its negative terminal (-) should both connect to the corresponding number with “B”, and then connect to “-” or “G”. Use the following diagram as an alarm output connection example for DC equipment.</p>  <p>When an equipment uses AC power supply, its positive terminal (+) should connect to a number with “A”, and its negative terminal (-) should connect to the corresponding number with “B”.</p> <p>Use the following diagram as an alarm output connection example for AC equipment.</p> |

| Item | Description |
|---------------|--|
| | <div data-bbox="443 293 798 660" data-label="Diagram"> </div> <div data-bbox="817 645 938 689" data-label="Text"> <p>Note</p> </div> <div data-bbox="434 701 1444 817" data-label="Text"> <p>For the reason that the AC load voltage could be high, please use an external relay for safety. Use the following diagram for reference.</p> </div> <div data-bbox="571 835 1321 1086" data-label="Diagram"> </div> <div data-bbox="571 1099 1050 1126" data-label="Text"> <p>Note: n represents a number in nA or nB, n can be 1 to 9.</p> </div> |
| <p>KB</p> | <p>KB represents keyboard. Connect “D+” and “D-” to “T+” and “T-” respectively. Use the following diagram for reference.</p> <div data-bbox="753 1301 1125 1630" data-label="Diagram"> </div> |
| <p>RS-485</p> | <p>RS-485 is an electrical specification of a two-wire, half-duplex, multipoint serial connection. Connect “T+” and “T-” to “A+” and “B-” respectively. Use the following diagram for reference.</p> |

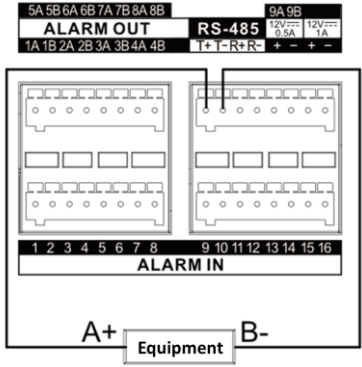
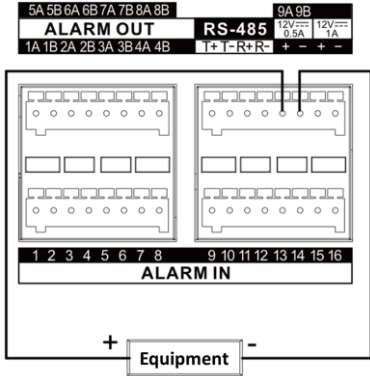
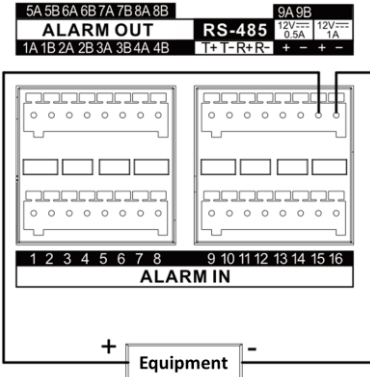
| Item | Description |
|--|--|
| |  |
| <p>Ctrl 12V/$\begin{matrix} 12V\text{---} \\ 0.5A \end{matrix}$</p> | <p>Controllable 12 VDC and 0.5/1 A power output for external alarm device. The power will be turned on when the corresponding alarm output is triggered.</p> <p>Use the following diagram for reference.</p>  |
| <p>DC 12V/$\begin{matrix} 12V\text{---} \\ 1A \end{matrix}$</p> | <p>It provides 12 VDC and 1 A power output.</p> <p>Use the following diagram for reference.</p>  |

HDD Installation

If your device does not support HDD hot swapping, disconnect the power from the device before installing a hard disk drive (HDD). A factory recommended HDD should be used for this installation.

Bracket Installation

Bracket installation is applicable when it requires to remove the device cover, and install HDD on the internal bracket.

Steps

1. Unfasten screws on the back, and push the cover backwards to remove the cover.

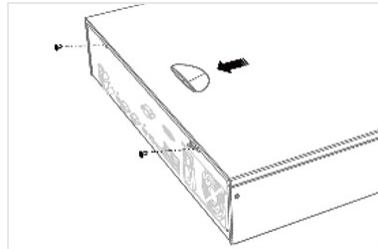

Figure 1-1 Remove Cover

2. Fix the HDD on the bracket with screws.

Note

Please uninstall the upper layer bracket first before installing HDD on the lower layer bracket.

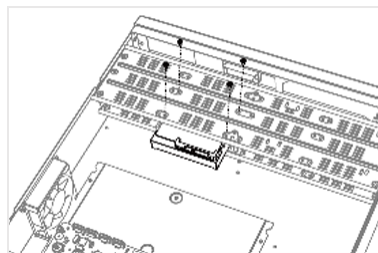

Figure 1-2 Fix HDD

3. Connect the data cable and power cable.

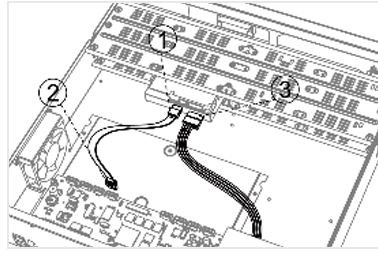

Figure 1-3 Connect Cable

Note

You can repeat the steps above to install other HDDs.

4. Reinstall the device cover and fasten screws.

Front Panel Plug-Pull Installation

Front panel plug-pull installation is applicable when you need to open the device front panel with key and install the HDD.

Steps

1. Fix mounting ears to HDD with screws.

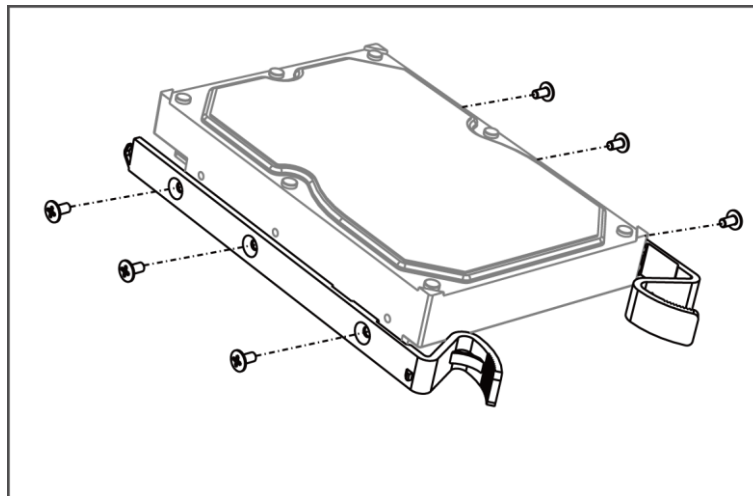

Figure 1-4 Fix Mounting Ears to HDD

2. Unlock the front panel with the attached key, and press the buttons on both sides of the front panel to open it.

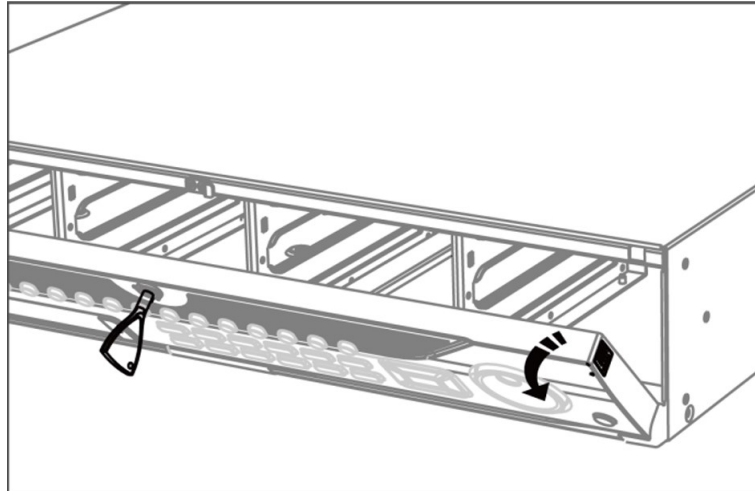

Figure 1-5 Open Front Panel

3. Insert the HDD until it is fixed firmly.

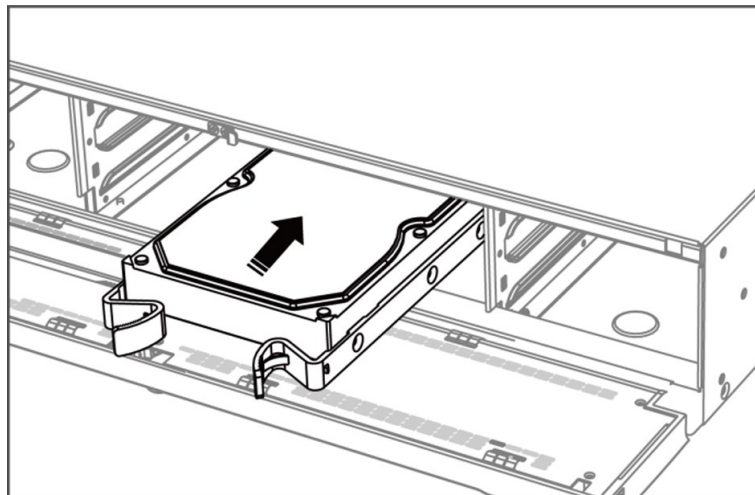

Figure 1-6 Insert HDD

4. Optional: Repeat the steps above to install other HDDs.
5. Close the front panel and lock it with key.

HDD Case Installation

HDD case installation refers to the method that you install the HDD in the case, and then plug the HDD case into the slot.

Steps

1. Unlock the front panel with panel key.
2. Pull the front panel out of the device and make it a little above the left handle.

Note

The angle between the front panel and the device must be within 10°.

3. Press the blue button to pop up the handle and hold the handle and pull the HDD case out of the slot.
4. Fix the hard disk in the HDD case.
 - 1) Place a HDD in the case. The SATA interface must face the case bottom.
 - 2) Adjust the HDD position. Ensure the hard disk rear aligns with HDD bottom.
 - 3) Use a screwdriver to fasten the four screws into the screw holes in both sides.

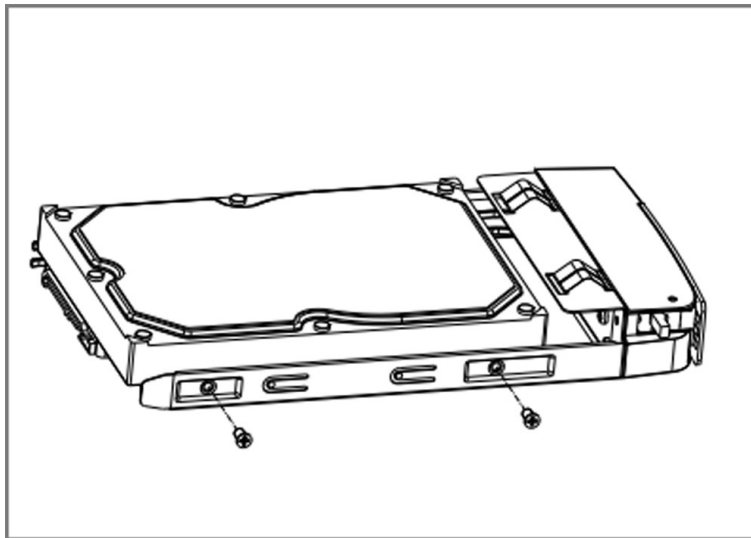

Figure 1-7 Fix HDD

5. Push the HDD case back into the slot.

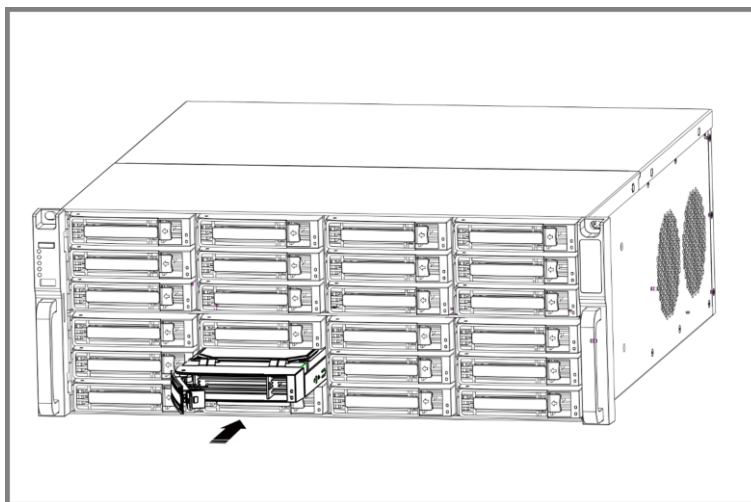

Figure 1-8 Push HDD Case into Slot

6. Press the handle until you hear a click. Thus to fix the HDD case. Repeat above steps to install the rest hard disk boxes.

7. Close the front panel, and lock it with the panel key.

Fix-on-Bottom Installation

Fix-on-bottom installation is applicable when you need to install and fix the HDD on the device bottom.

Steps

1. Remove the cover from device by unfastening the screws on panels.

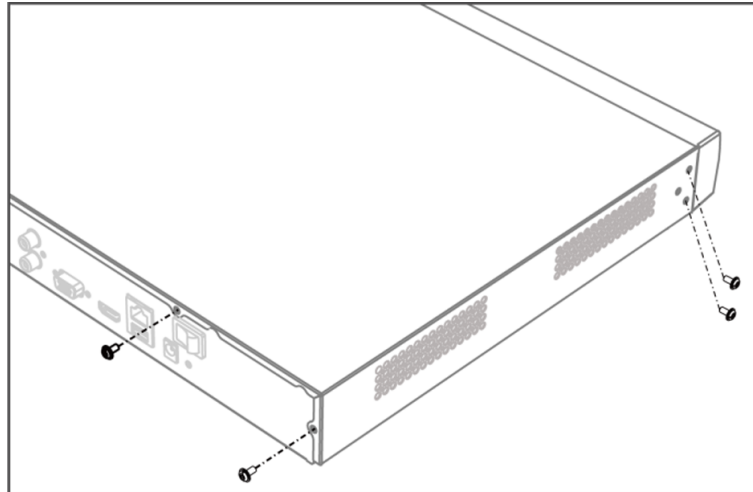

Figure 1-9 Remove Cover

2. Connect the data cable and power cable.

- 1) Connect one end of data cable to the device motherboard.
- 2) Connect the other end of data cable to HDD.
- 3) Connect one end of power cable to HDD.
- 4) Connect the other end of power cable to the device motherboard.

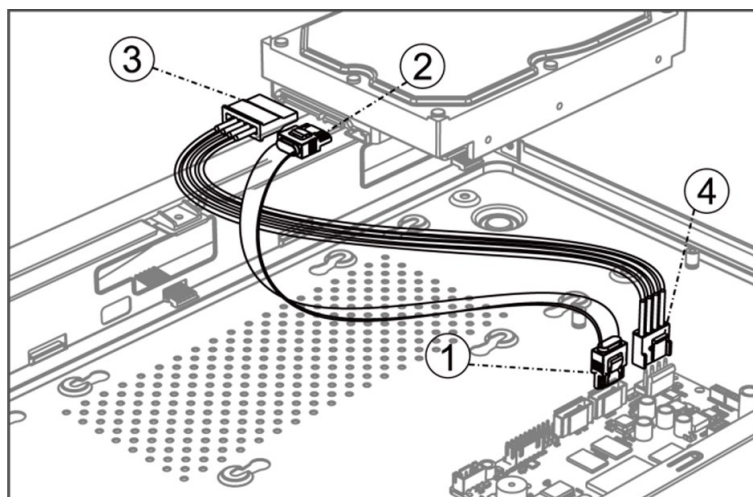

Figure 1-10 Connect Cables

3. Set the device up, match HDD screw threads with the reserved holes on the device bottom, and fix HDD with screws.

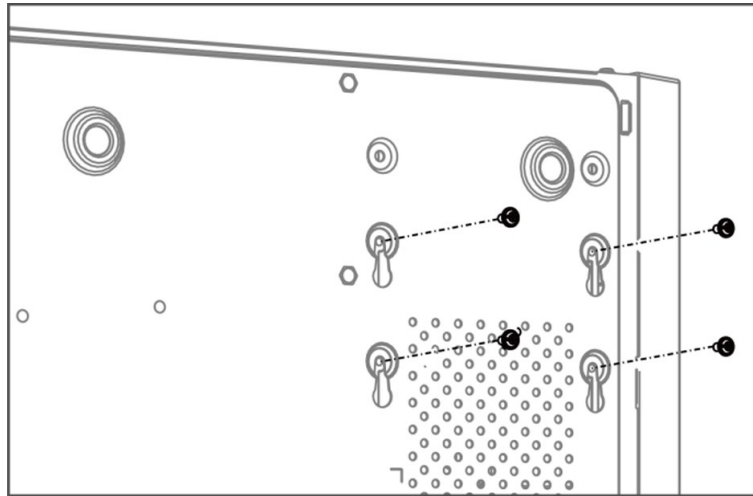

Figure 1-11 Fix HDD to Device Bottom

4. Optional: Repeat the steps above to install other HDDs.
5. Reinstall the device cover and fasten screws.

Coin/Button Cell Battery Replacement

The coin/button cell battery should be replaced when the device has been powered off or placed for a long time, and the system time is incorrect.

Before You Start

Power off your device.

Steps

1. Remove the device chassis cover.
2. Find the coin/button cell battery on motherboard.
3. Put the thumb outside the battery slot, and use the index finger to push the positive contact spring outward gently. The battery will pop up automatically.

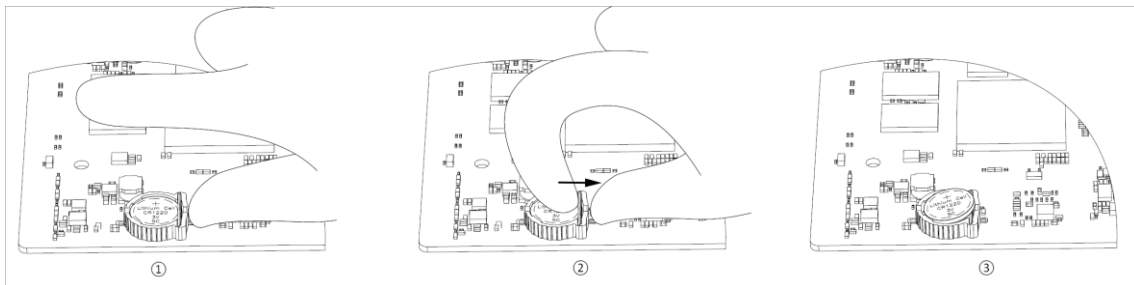

Figure 1-1 Remove Battery

Note

- You should wear anti-static gloves when removing the battery.
- If the spring is deformed due to excessive force when pushing outward, it needs to be adjusted back into its original position before inserting the battery.

4. Insert the battery diagonally towards the side with the plastic snap point in the battery slot, and then press the battery near the positive contact spring to snap it beneath the spring.

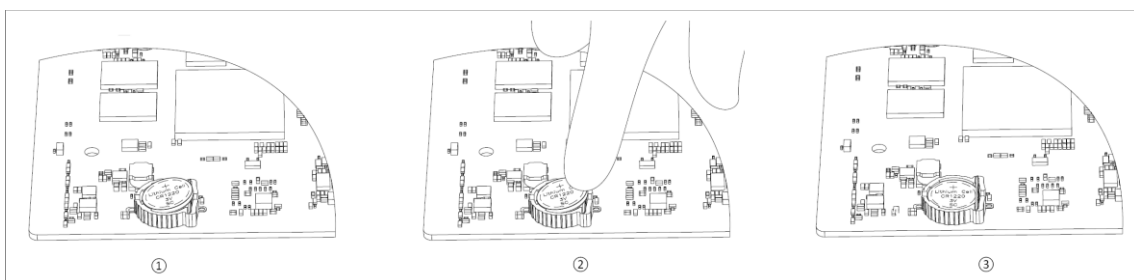

Figure 1-2 Replace Battery

 **Note**

You should wear anti-static gloves when replacing the battery.

5. Reinstall the device chassis cover.

What to do next

If the system time is incorrect, please go to configure the time.

Contents

| | |
|---|-----------|
| Chapter 1 Activate via Local Menu | 1 |
| Chapter 2 Log in to Your Device | 3 |
| Chapter 3 User Interface Introduce | 4 |
| Chapter 4 Network Settings | 6 |
| 4.1 Network Parameter Settings | 6 |
| 4.1.1 Configure TCP/IP | 6 |
| 4.1.2 Configure DDNS | 7 |
| 4.1.3 Configure PPPoE | 8 |
| 4.1.4 Configure Multicast | 9 |
| 4.2 Platform Access Settings | 9 |
| 4.2.1 Configure PT Cloud | 9 |
| 4.2.2 Configure OTAP | 11 |
| 4.2.3 Configure ISUP | 11 |
| 4.2.4 Configure SDK Service | 13 |
| 4.2.5 Enable ISAPI | 13 |
| 4.2.6 Configure ONVIF | 14 |
| 4.2.7 Configure Log Server | 15 |
| 4.3 Network Service Settings | 15 |
| 4.3.1 Configure HTTP(S) | 15 |
| 4.3.2 Configure RTSP | 16 |
| 4.3.3 Configure WebSocket(s)..... | 17 |
| 4.3.4 Configure Port Mapping (NAT) | 17 |
| 4.3.5 Configure IoT | 19 |
| Chapter 5 User Management | 20 |
| Chapter 6 Device Access | 21 |
| 6.1 Access Video Device | 21 |
| 6.1.1 Add Automatically Searched Online Network Camera..... | 21 |
| 6.1.2 Add Network Camera Manually | 21 |
| 6.1.3 Add Network Camera through PoE | 23 |

| | |
|--|----|
| 6.1.4 Add Solar-Powered Camera through OTAP Protocol | 23 |
| 6.1.5 Add Network Camera via Custom Protocol | 24 |
| 6.1.6 Add Network Camera through Camera Configuration File | 25 |
| 6.2 Add Access Control Device | 25 |
| 6.3 Add Security Control Panel | 26 |
| 6.4 Add Audio Device | 26 |
| 6.5 Add POS Device | 26 |
| 6.6 Channel Management | 28 |
| Chapter 7 Device Grouping | 29 |
| Chapter 8 Video or Audio Device Settings | 30 |
| 8.1 Enable H.265 Stream Access | 30 |
| 8.2 Configure Display Settings | 30 |
| 8.3 Configure Video Parameters | 31 |
| 8.4 Configure Privacy Mask | 31 |
| 8.5 Configure Privacy Protection | 32 |
| 8.6 Configure Audio Parameter | 34 |
| 8.7 Configure OTAP Service | 34 |
| 8.8 Batch Configuration | 35 |
| 8.9 Configure PoE (Power over Ethernet) Interface | 36 |
| Chapter 9 Storage Management | 38 |
| 9.1 Manage HDD | 38 |
| 9.2 RAID Configuration | 39 |
| 9.2.1 Create Disk Array | 39 |
| 9.2.2 Rebuild Array | 41 |
| 9.2.3 Delete Array | 42 |
| 9.2.4 View Firmware Info | 42 |
| 9.3 Configure Storage Mode | 42 |
| 9.4 Configure Other Storage Parameters | 43 |
| 9.5 Mangle USB Flash Drive | 43 |
| Chapter 10 Schedule Configuration | 44 |
| 10.1 Configure Schedule Template | 44 |

| | |
|---|-----------|
| 10.2 Configure Recording Schedule | 46 |
| 10.3 Configure Picture Capture Schedule | 48 |
| 10.4 Configure Audio Recording | 50 |
| Chapter 11 Live View | 51 |
| 11.1 Configure Live View Layout..... | 51 |
| 11.2 GUI Introduction..... | 51 |
| 11.3 PTZ Control | 52 |
| Chapter 12 Playback..... | 54 |
| 12.1 GUI Introduction..... | 54 |
| 12.2 Normal Playback..... | 55 |
| 12.3 Event Playback..... | 56 |
| 12.4 Slice Playback | 57 |
| 12.5 Sub-Period Playback..... | 57 |
| Chapter 13 Event Center..... | 59 |
| 13.1 Event Settings | 59 |
| 13.1.1 Basic/Generic Event | 59 |
| 13.1.2 Perimeter Protection..... | 61 |
| 13.1.3 Abnormal Behavior Event | 71 |
| 13.1.4 Target Event..... | 74 |
| 13.1.5 Thermal Camera Detection | 76 |
| 13.1.6 Alarm Input Event | 78 |
| 13.1.7 Audio Analysis Event | 81 |
| 13.2 Linkage Configuration | 83 |
| 13.3 Disarming Configuration | 85 |
| 13.4 Batch Configuration | 86 |
| 13.5 Event Search | 86 |
| 13.6 View Alarms..... | 87 |

| | |
|---|------------|
| Chapter 14 Search and File Management | 88 |
| Chapter 15 DeepVision | 90 |
| Chapter 16 Direct Search | 93 |
| Chapter 17 Smart Settings | 95 |
| 17.1 Algorithm Management | 95 |
| 17.2 Engine Status | 95 |
| 17.3 Task Plan Management | 95 |
| 17.4 List library Management | 96 |
| 17.4.1 Add a List Library | 96 |
| 17.4.2 Upload Face Pictures to the Library | 96 |
| 17.5 Self-Learning Settings | 97 |
| 17.5.1 Self-Learning Task Management | 97 |
| 17.5.2 Model Management | 98 |
| 17.5.3 Smart Status | 98 |
| Chapter 18 Application Center | 99 |
| 18.1 Person Check-In | 99 |
| 18.1.1 Add Check-In Task | 99 |
| 18.1.2 Search Check-In Records | 100 |
| 18.2 Statistic Report | 101 |
| Chapter 19 System Parameter Settings | 102 |
| Chapter 20 Hot Spare Device Backup | 104 |
| 20.1 Set Working Device | 104 |
| 20.2 Set Hot Spare Device | 104 |
| Chapter 21 Configure Exception Event | 106 |
| Chapter 22 View System Info | 108 |
| Chapter 23 System Maintenance | 109 |
| 23.1 Schedule Reboot | 109 |
| 23.2 Upgrade Device | 109 |
| 23.3 Backup and Restore | 109 |
| 23.4 Log Info | 109 |
| 23.5 Configure Log Server | 110 |

| | |
|--|------------|
| 23.6 Maintenance Tools | 110 |
| 23.7 Soft Power Off Configuration | 111 |
| Chapter 24 Security Management | 113 |
| 24.1 Address Filter | 113 |
| 24.2 Stream Encryption | 113 |
| 24.3 Select TLS Version..... | 113 |
| Chapter 25 Appendix..... | 115 |
| 25.1 Glossary | 115 |
| 25.2 Frequently Asked Questions | 116 |
| 25.2.1 Why is there a part of channels displaying “No Resource” or turning black screen in multi-screen live view?..... | 116 |
| 25.2.2 Why is the video recorder notifying risky password after a network camera is added? | 117 |
| 25.2.3 Why is the video recorder notifying the stream type not supported? | 117 |
| 25.2.4 How to confirm the video recorder is using H.265 to record video? | 117 |
| 25.2.5 Why is the video recorder notifying IP conflict? | 118 |
| 25.2.6 Why is image getting stuck when playing back by single or multi-channel cameras? | 118 |
| 25.2.7 Why is the device not able to control PTZ camera via coaxitron? | 118 |
| 25.2.8 Why does the PTZ seem unresponsive via RS-485?..... | 118 |
| 25.2.9 Why is the video sound quality not good?..... | 119 |
| 25.3 Notification for Corrosive Gas | 119 |

Chapter 1 Activate via Local Menu

For the first time access, you must set an admin password to activate your device. No operation is allowed before activation. You can also activate the device via web browser, IP Portal or client software.

Before You Start

Ensure your device is connected with a monitor and mouse.

Steps

1. Power on your device.
2. Set the region or DST (Daylight Saving Time) parameters.
3. Select a system language.
4. Enter the admin password twice.

Caution

We highly recommend you create a strong password of your own choosing (using a minimum of 8 characters, including at least three kinds of following categories: upper case letters, lower case letters, numbers, and special characters) in order to increase the security of your product. And we recommend you change your password regularly, especially in the high security system, changing the password monthly or weekly can better protect your product.

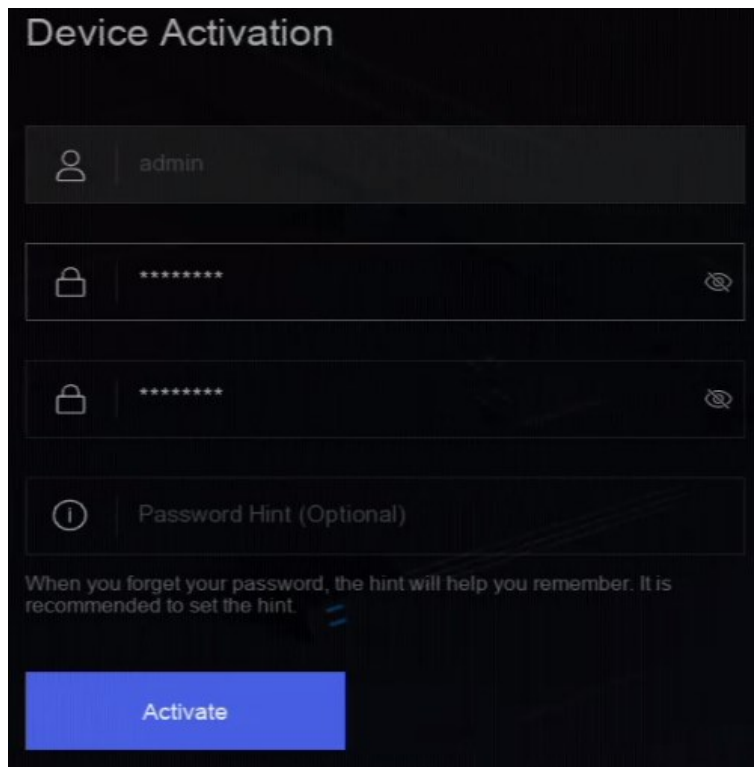

Figure 1-1 Activate via Local Menu

5. Optional: Enter a password hint. It will help you remember your password when you forget.
6. Click **Activate**.

Note

After the device is activated, you should properly keep the password.

7. Optional: Draw an unlock pattern.
8. Configure at least one password recovery method.

What to do next

Follow the wizard to set basic parameters.

Chapter 2 Log in to Your Device

You must log in to your device before operating the menu and other functions.

Before You Start

Ensure your device is activated.

Steps

1. Power on your device.
2. Right click to display the shortcut menu.
3. Select an item as needed. For example, select **Exit Full Screen**, and you would automatically enter the login interface.

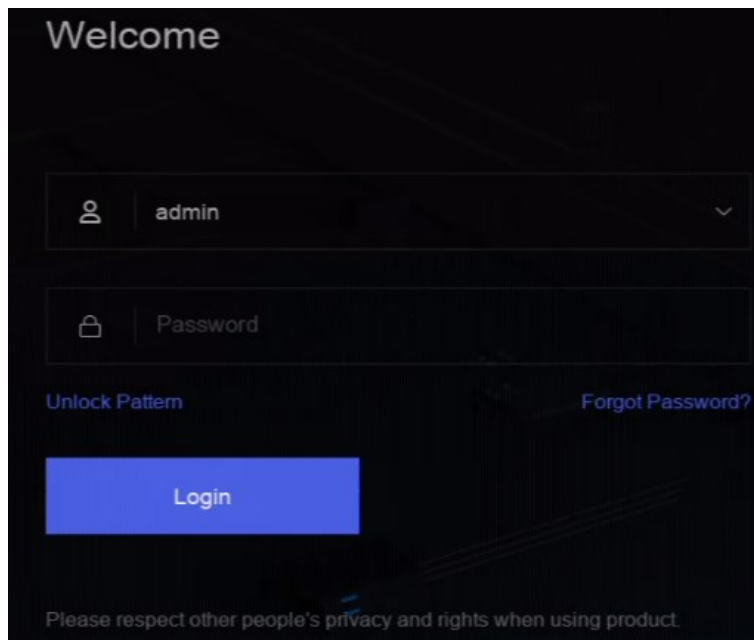

Figure 2-1 Login

4. Use the unlock pattern to log in, or click **Password Login** to log in via user name and password.

Note

- Unlock pattern is only available for admin user.
 - If you forget your unlock pattern or login password, click **Forget Password** at the password login interface to reset your password, or use the password hint to remember.
-

Chapter 3 User Interface Introduce

The device will enter the live view interface after it is powered on. Right click your mouse and select **Exit Full Screen** through the shortcut menu.

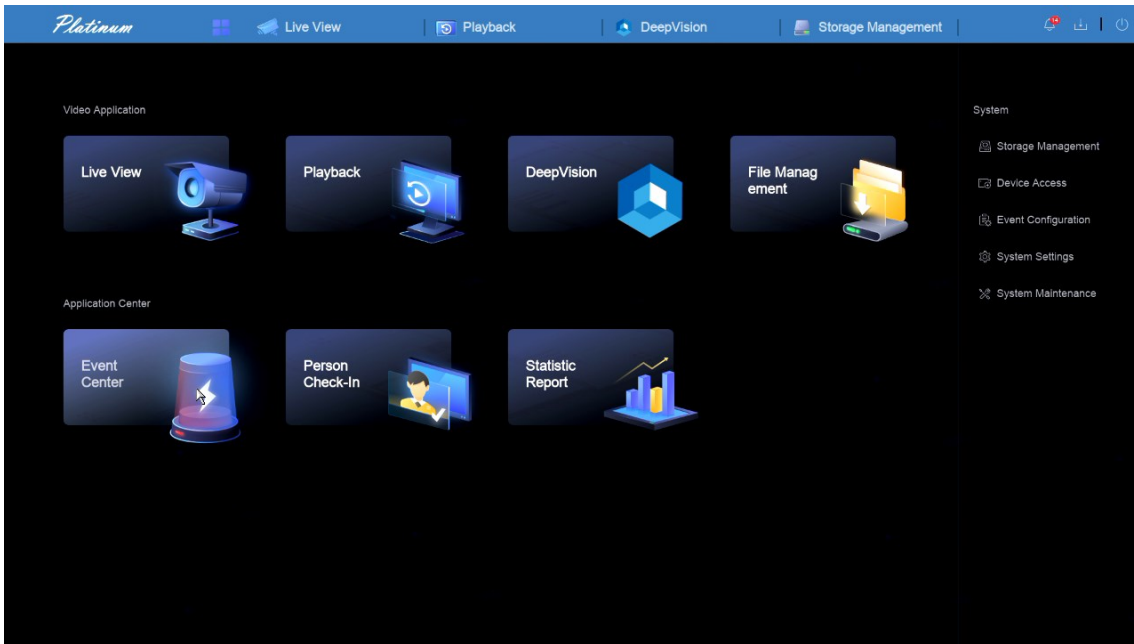

Figure 3-1 Main Function Page

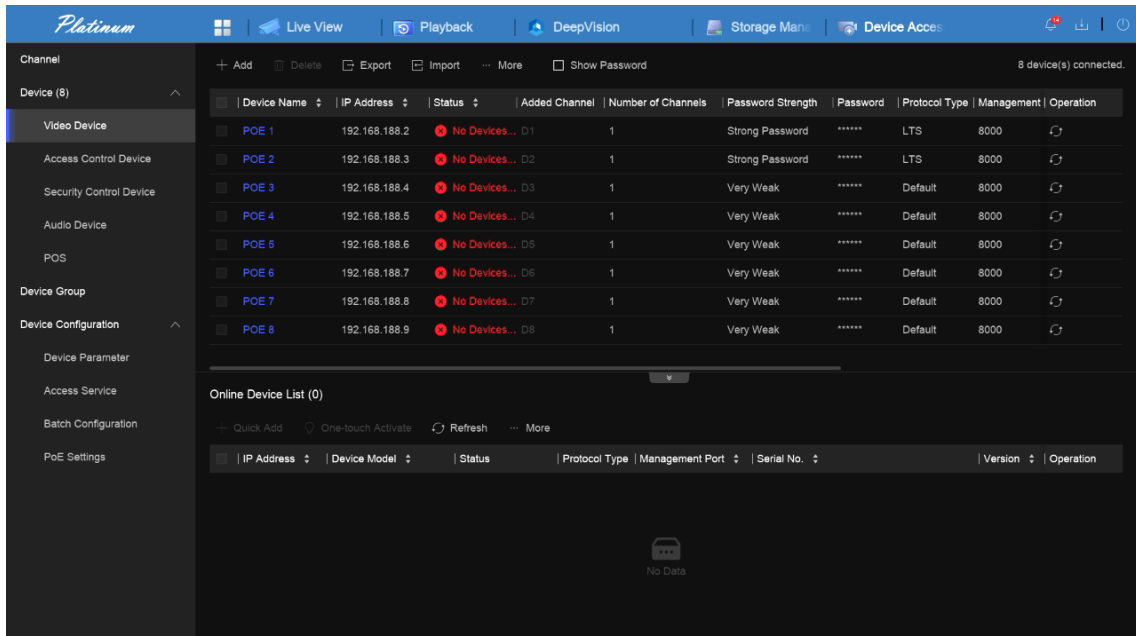







Figure 3-2 Menu Bar Example

Table 3-1 Interface Introduction

| Interface Name | Introduction |
|------------------|---|
| Task Bar | <p>The opened applications are listed in the task bar. You can move and close each application tab.</p> <p>Icon introduction:</p> <ul style="list-style-type: none"> ● : Main menu. ● : Event center. Event alarms can be searched and viewed. ● : The download progress of each download task can be viewed here. ● : Shut down, log out, or reboot your device. |
| Application List | All applications are displayed here. You can click one to configure it. |
| Navigation Bar | Click to configure each function of the system. |
| Menu Bar | <p>Configurable items of each application are listed here.</p> <hr/> <p> Note</p> <p>For applications in Application Center, you can click , or right click to display the menu bar.</p> <hr/> |

Chapter 4 Network Settings

Network parameters, platform access settings, and network services are configurable.

4.1 Network Parameter Settings

You should configure network parameters before using functions that require network access.

4.1.1 Configure TCP/IP

TCP/IP must be properly configured before you operate video recorder over network or access network devices.

Steps

1. Go to **Desktop** → **System Settings** → **Network** → **Network** → **TCP/IP**.

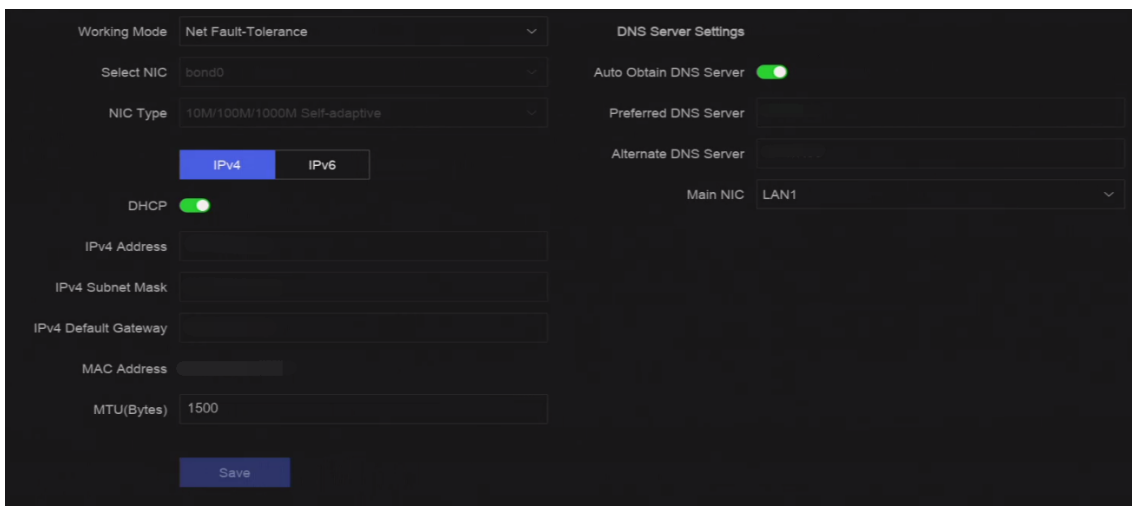

Figure 4-1 TCP/IP Settings

2. Set **Working Mode** and **Select NIC**.

Multi-address

The parameters of the two NIC cards can be configured independently. You can select **LAN1** or **LAN2** in the NIC type field for parameter settings. You can select one NIC card as default route. And then the system is connected with the extranet, and the data will be forwarded through the default route.

Net-fault Tolerance

The two NIC cards use the same IP address, and you can set **Main NIC** to **LAN1** or **LAN2**. By this way, in case of one NIC card failure, the video recorder will automatically enable the

other standby NIC card so as to ensure the normal running of the whole system.

Note

Working mode is only available for certain models.

3. Configure network parameters.

IPv4

DHCP

If the DHCP server is available, you can enable **DHCP** to automatically obtain an IP address and other network settings from that server.

MTU

The maximum transmission unit (MTU) is the size of the largest network layer protocol data unit that can be communicated in a single network transaction.

Auto Obtain DNS Server

If **DHCP** is enabled. You can check **Auto Obtain DNS Server** to obtain **Preferred DNS Server** and **Alternate DNS Server**.

IPv6

Router Advertisement

If the router in the network supports IPv6, it is recommended to use this mode as default.

Auto

If there is a DHCPv6 device in the network, it is recommended to use this mode

Manual Configuration

You should use this mode if you are going to manually enter IPv6 parameters.

4. Click **Save**.

4.1.2 Configure DDNS

Dynamic domain name server (DDNS) maps dynamic user IP addresses to a fixed domain name server.

Before You Start

Ensure you have registered DynDNS, PeanutHull, and NO-IP services with your ISP.

Steps

1. Go to **Desktop** → **System Settings** → **Network** → **Network** → **DDNS**.

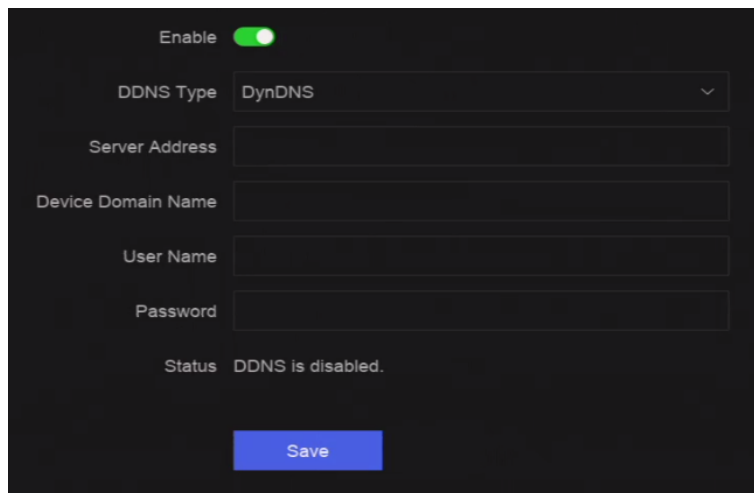

Figure 4-2 DDNS

2. Turn on **Enable**.
3. Select a DDNS type.
4. Set parameters, including service address, domain name, etc.
5. Click **Save**.

4.1.3 Configure PPPoE

If the device is connected to Internet through PPPoE, you need to configure user name and password accordingly. Contact your Internet service provider for details about PPPoE service.

Steps

1. Go to **Desktop** → **System Settings** → **Network** → **Network** → **PPPoE**.

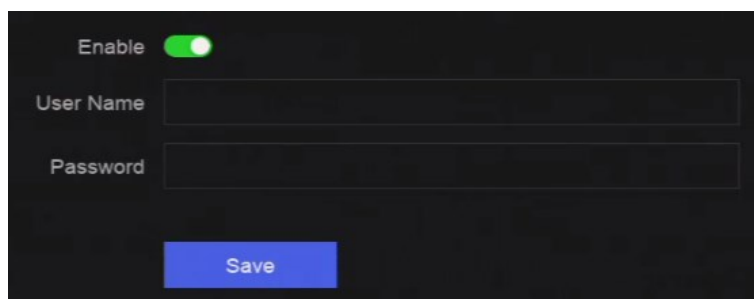

Figure 4-3 PPPoE

2. Turn on **Enable**.
3. Enter user name and password.
4. Click **Save**.

What to do next

Go to **Desktop** → **System Maintenance** → **Running Info** → **Status** to view PPPoE status.

4.1.4 Configure Multicast

Multicast can be configured to enable live view for cameras that exceed the maximum number allowed through network.

Steps

1. Go to **Desktop** → **System Settings** → **Network** → **Network** → **Other**.
2. Set **Multicast** parameters.

Note

- When adding device through network video security client, multicast group IP address should be the same as the device multicast IP address.
 - For IPv4, it covers Class-D IP ranging from 224.0.0.0 to 239.255.255.255 and it is recommended to use an IP address ranging from 239.252.0.0 to 239.255.255.255. When adding a device to the CMS software, the multicast address must be the same as that of the device.
-

3. Click **Save**.

4.2 Platform Access Settings

4.2.1 Configure PT Cloud

PT Cloud provides mobile phone applications and platform service to access and manage your video recorder, which enables you to get convenient remote access to the video security system.

Steps

1. Go to **Desktop** → **System Settings** → **Network** → **PT Cloud**.

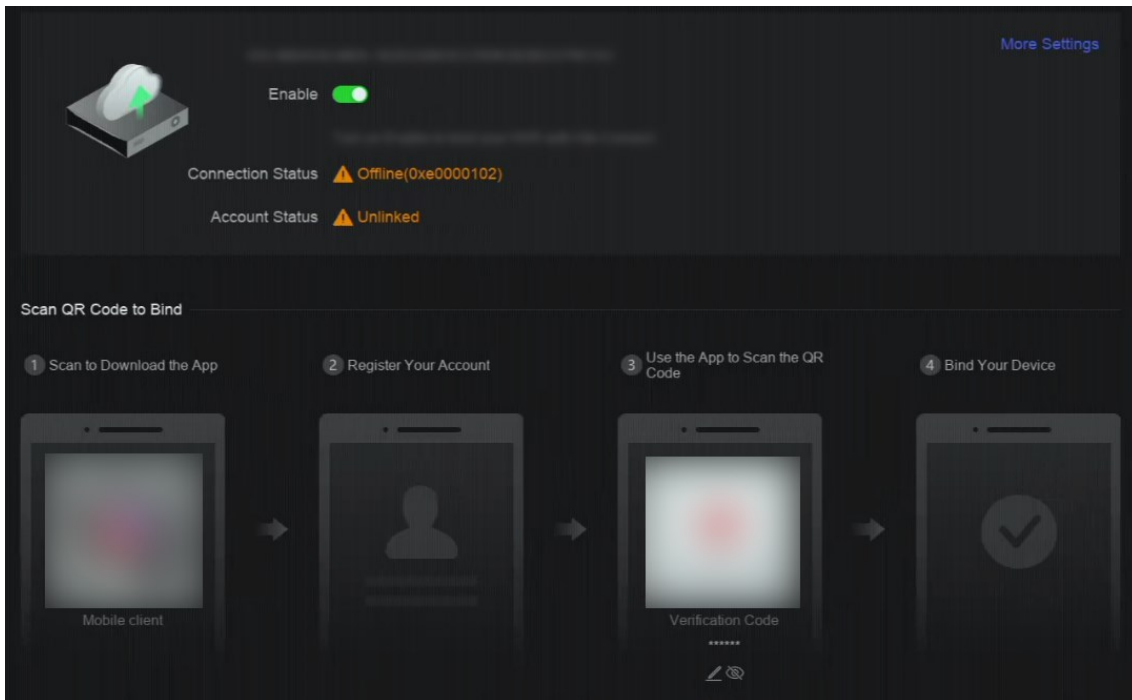

Figure 4-4 PT Cloud

2. Turn on **Enable**, and the service terms will pop up.
3. Accept the service terms.
4. Download LTS Connect app. You can use a smart phone to scan the QR code to download LTS Connect app.
5. Register an account at the app.
6. Optional: Click **More Settings** to enable **Stream Encryption**, **Platform Time Sync**, and **Adaptive Bitrate Streaming**, or edit **Server IP Address**.

Stream Encryption

It requires to enter verification code in remote access and live view after this function is enabled.

Platform Time Sync

The device will sync time with LTS Connect instead of NTP server.

Adaptive Bitrate Streaming

When the network environment is poor, the device would automatically adjust video bitrate to ensure playing fluency.

Server IP Address

The LTS Connect server IP address.

7. Click  to set verification code.
8. Use LTS Connect app to scan the device QR and bind the device with your LTS Connect account.

Note

If the device is already bound with an account, you can click **Unbind** to unbind with the current account.

Result

- If your device is connected with LTS Connect, **Connection Status** will be **Online**.
- If your device is bound with an LTS Connect account, **Account Status** will be **Linked**.

What to do next

You can access your video recorder via LTS Connect app.

4.2.2 Configure OTAP

OTAP (Open Thing Access Protocol) is a unified integrated standard and push-pull mode of LTS Connect protocol in the public network and private network. After OTAP is enabled, other applications may be able to remotely view videos through this protocol.

Before You Start

Ensure your device network is accessible through OTAP.

Steps

1. Go to **Desktop** → **System Settings** → **Network** → **Platform Access** → **OTAP**.

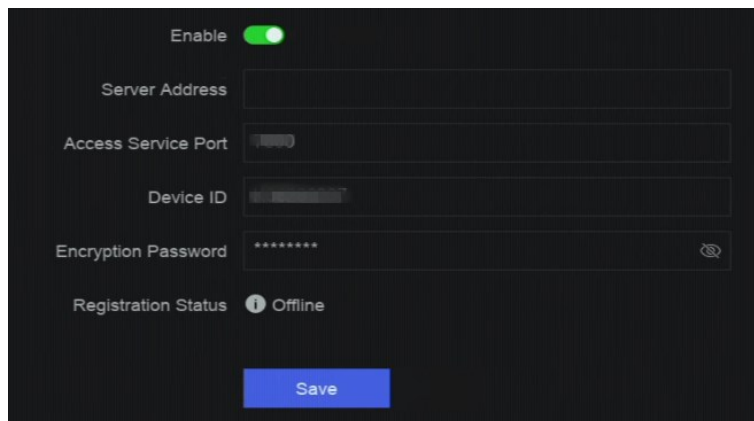

Figure 4-5 OTAP

2. Turn on **OTAP**.
3. Set the parameters.
4. Click **Save**.

4.2.3 Configure ISUP

ISUP (Intelligent Security Uplink Protocol) provides APIs, library files, and commands for the third-

party platform to access devices such as NVRs, speed domes, DVRs, network cameras, mobile NVRs, mobile devices, decoding devices, etc. With this protocol, the third-party platform can realize functions like live view, playback, two-way audio, PTZ control, etc.

Steps

1. Go to **Desktop** → **System Settings** → **Network** → **Platform Access** → **ISUP**.

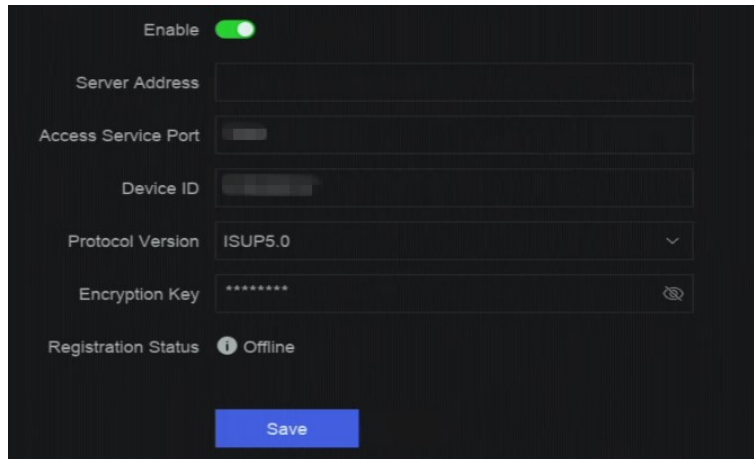

The screenshot shows a configuration window for ISUP. At the top, there is an 'Enable' toggle switch which is turned on (green). Below it are several input fields: 'Server Address', 'Access Service Port', and 'Device ID'. The 'Protocol Version' is set to 'ISUP5.0' with a dropdown arrow. The 'Encryption Key' is masked with asterisks. At the bottom left, the 'Registration Status' is shown as 'Offline' with an information icon. A blue 'Save' button is located at the bottom center.

Figure 4-6 ISUP

2. Turn on **Enable**.

Note

If ISUP is enabled, the LTS Connect access will automatically be disabled.

3. Set the related parameters.

Server Address

The platform server IP address.

Access Server Port

The platform server port, ranges from 1024 to 65535. The actual port shall be provided by the platform.

Device ID

Device ID shall be provided by the platform.

Protocol Version

ISUP protocol version, only ISUP 5.0 is available.

Encryption Key

Encryption password is required when using ISUP V5.0 version, it provides more secure communication between the device and platform. Enter it for verification after the device is registered to the ISUP platform. It cannot be empty, or "ABCDEF".

4. Click **Save**.

You can see the registration status (online or offline) after the device is restarted.

4.2.4 Configure SDK Service

SDK (Software Development Kit) service is used for third-party partners to integrate different functions. The enhanced SDK service adopts TLS protocol over the SDK service that provides safer data transmission.

Steps

1. Go to **Desktop** → **System Settings** → **Network** → **Platform Access** → **SDK**.

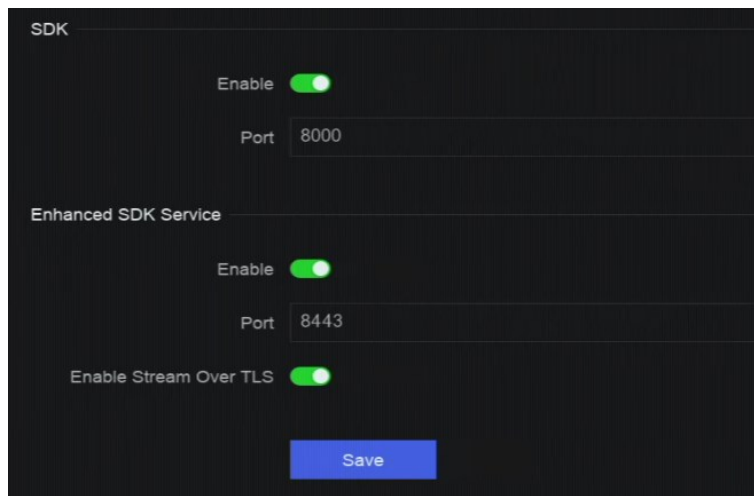

Figure 4-7 SDK Service

2. Configure **SDK** and **Enhanced SDK Service** according to your requirement.

Note

The port for **Enhanced SDK Service** is 8443 by default.

3. Optional: Enable **Stream Over TLS**. The stream over TLS encryption technology provides more secure stream transmission service.
4. Click **Save**.

4.2.5 Enable ISAPI

ISAPI (Internet Server Application Programming Interface) is an open protocol based on HTTP, which can realize the communication between the system devices (e.g., network camera, NVR, etc.).

Go to **Desktop** → **System Settings** → **Network** → **Platform Access** → **ISAPI** to enable the function.

4.2.6 Configure ONVIF

ONVIF protocol allows the connection with third-party cameras. The added user accounts have permission to connect other devices via ONVIF protocol.

Steps

1. Go to **Desktop** → **System Settings** → **Network** → **Platform Access** → **ONVIF**.

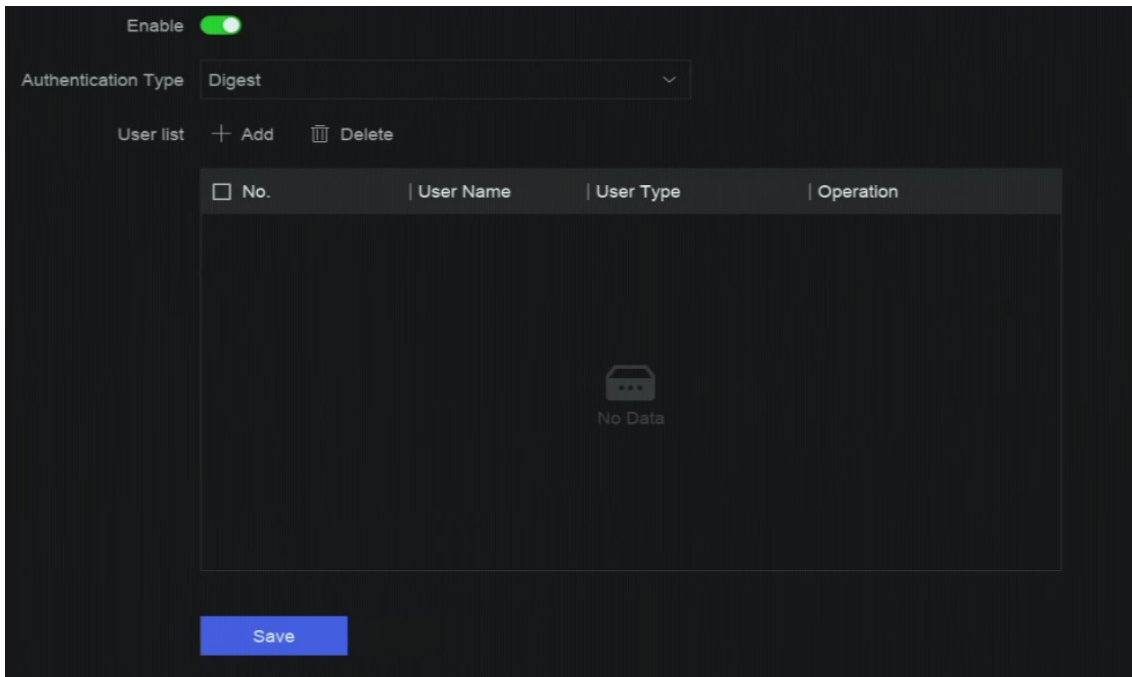

Figure 4-8 ONVIF

2. Turn on **Enable**.
3. Select an authentication type.
4. Click **Add** to add a user.
5. Set the user name and password.

Caution

We highly recommend you create a strong password of your own choosing (Using a minimum of 8 characters, including at least three of the following categories: upper case letters, lower case letters, numbers, and special characters.) to increase the security of your product. And we recommend you reset your password regularly, especially in the high security system, resetting the password monthly or weekly can better protect your product

6. Click **Save**.

4.2.7 Configure Log Server

Logs can be uploaded to the log server for backup.

Steps

1. Go to **Desktop** → **System Settings** → **Network** → **Platform Access** → **Log Server**.

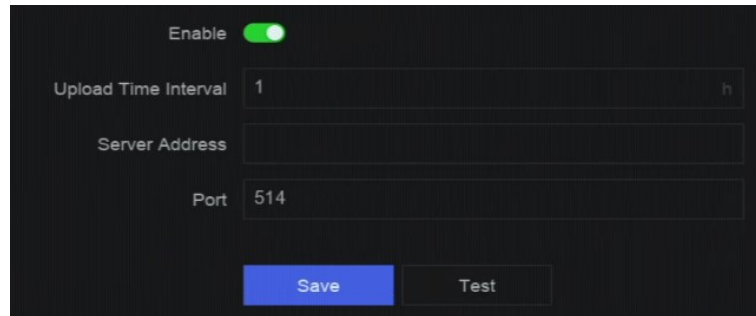

Figure 4-9 Log Server

2. Turn on **Enable**.
3. Set **Upload Time Interval**, **Server IP Address**, and **Port**.
4. Optional: Click **Test** to check if parameters are valid.
5. Click **Save**.

4.3 Network Service Settings

4.3.1 Configure HTTP(S)

HTTP ((Hyper Text Transfer Protocol) and HTTPS (Hypertext Transfer Protocol Secure) ports are used for remote access through web browser. HTTPS protocol enables encrypted transmission and identity authentication, which improves the security of remote access.

Steps

1. Go to **Desktop** → **System Settings** → **Network** → **Network Service** → **HTTP(S)**.

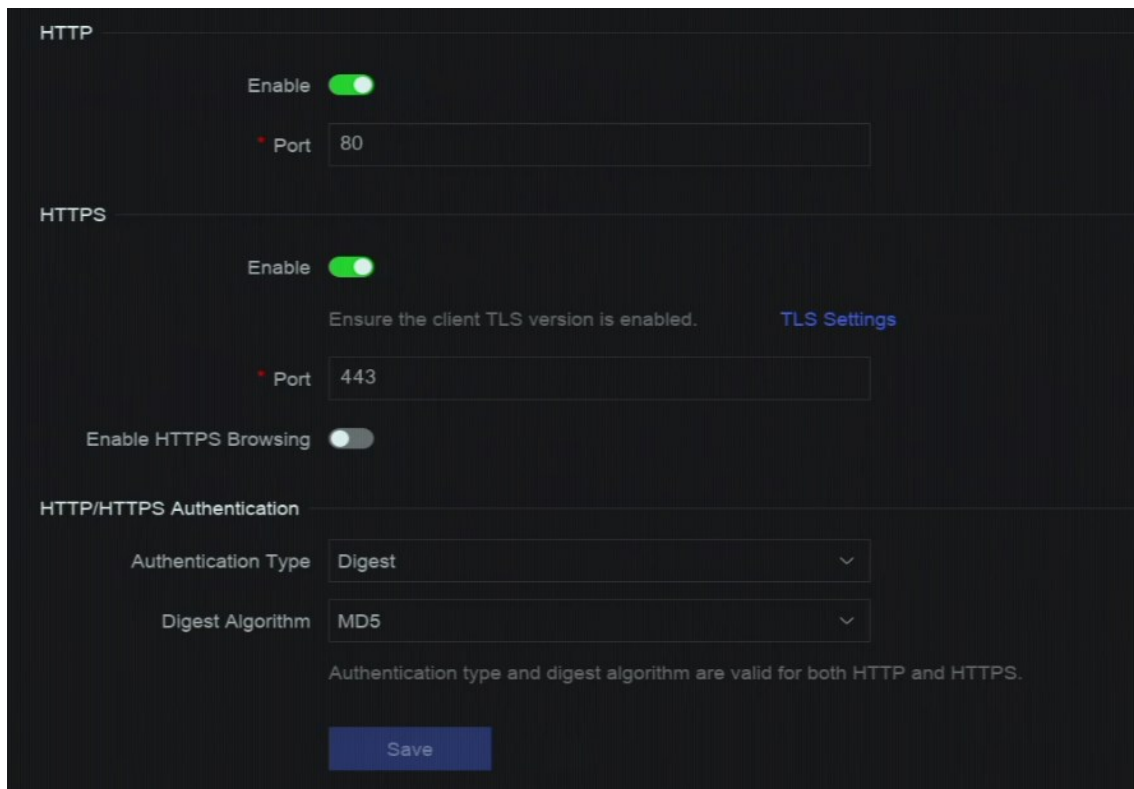

Figure 4-10 HTTP(S)

2. Optional: Turn on HTTP or HTTPS.
3. View or edit **Port** of HTTP or HTTPS.
4. Set **HTTP/HTTPS Authentication**.

Authentication Type

Two authentication types are selectable, for security reasons, it is recommended to select **Digest** as the authentication type.

Digest Algorithm

Digest algorithms are based on HTTP/HTTPS and are mainly used for the digest authentication of user authentication.

5. Click **Save**.

4.3.2 Configure RTSP

RTSP (Real Time Streaming Protocol) is a network control protocol designed to control streaming media servers. You can specifically secure the stream data of live view by setting the RTSP authentication.

Steps

1. Go to **Desktop** → **System Settings** → **Network** → **Network Service** → **RTSP**.

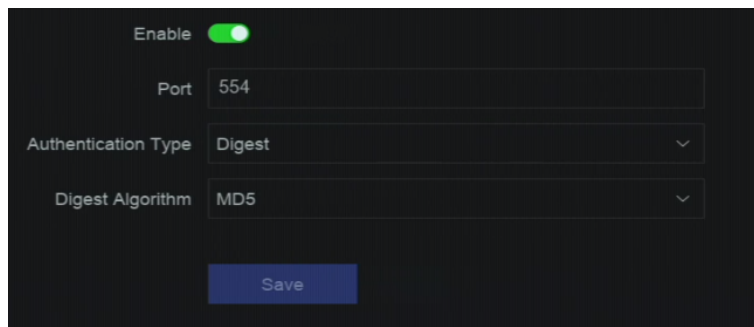

Figure 4-11 RTSP

2. Set parameters.

Port

The port is 554 by default.

Authentication Type

Two authentication types are selectable, if you select **Digest**, only the request with digest authentication can access the video stream by RTSP via the IP address. For security reasons, it is recommended to select **Digest** as the authentication type.

RTSP Digest Algorithm

RTSP digest algorithm is based on RTSP, it is an algorithm for digest authentication of the user authentication.

3. Click **Save**.

4.3.3 Configure WebSocket(s)

WebSocket protocol, based on TCP, aims to provide full-duplex communication between web browsers and servers. It allows to open a two-way interactive communication session.

Steps

1. Go to **Desktop** → **System Settings** → **Network** → **Network Service** → **WebSocket(s)**.
2. Turn on **Enable**.
3. Set **Port**.
4. Click **Save**.

4.3.4 Configure Port Mapping (NAT)

Two ways are provided for port mapping to realize the remote access via the cross-segment network, UPnP™ (Universal Plug and Play), and manual mapping. UPnP™ can permit the device seamlessly discover the presence of other network devices on the network and establish functional network services for data sharing, communications, etc. You can use the UPnP™ function to enable the fast connection of the device to the WAN via a router without port

mapping.

Before You Start

If you want to enable the UPnP™ function of the device, you must enable the UPnP™ function of the router to which your device is connected. When the network working mode of the device is set as multi-address, the Default Route of the device should be in the same network segment as that of the LAN IP address of the router.

Steps

1. Go to **Desktop** → **System Settings** → **Network** → **Network Service** → **NAT**.

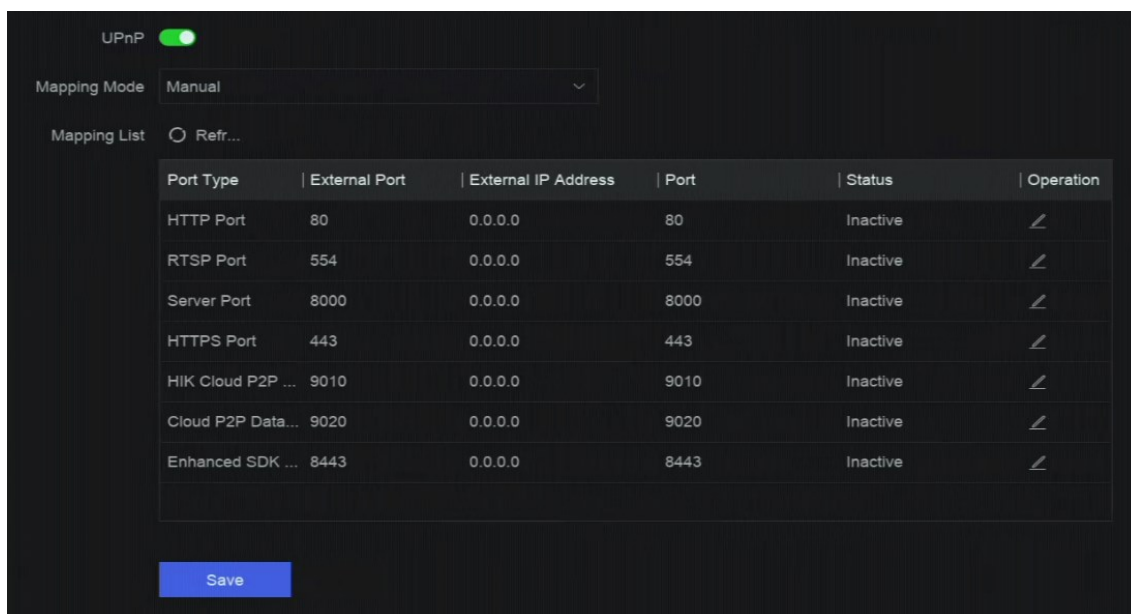

Figure 4-12 Port Mapping (NAT)

2. Turn on **Enable UPnP**.
3. Set **Mapping Mode**.

Auto

The port mapping items are read-only, and the external ports are set by the router automatically.

Manual

You can manually edit the external port.

4. If **Mapping Mode** is selected as **Manual**, click to edit corresponding ports.

Note

- The value of the RTSP port number should be 554 or between 1024 and 65535, while the value of the other ports should be between 1 and 65535 and the value must be different from each other. If multiple devices are configured for the UPnP™ settings under the same router, the value of the port No. for each device should be unique.

- **External Port** indicates the internal port number for port mapping in the router.
-

5. Click **Save**.

What to do next

Enter the virtual server settings page of router, then fill in the blank of internal/external source port with the internal/external port value, and other required contents.

4.3.5 Configure IoT

You can configure the network port through which the NVR will receive alarms from a security control panel.

Go to **Desktop** → **System Settings** → **Network** → **Network Service** → **IoT** to enable the function and configure the port number.

Note

The port number you configured here should be the same as the alarm sending port on the security control panel.

Chapter 5 User Management

There is a default account for administrator. The administrator user name is **admin**. Administrator has the permission to add, delete, and edit user. Guest and operator users only have limited permissions.

Go to **Desktop** → **System Settings** → **User Management**.

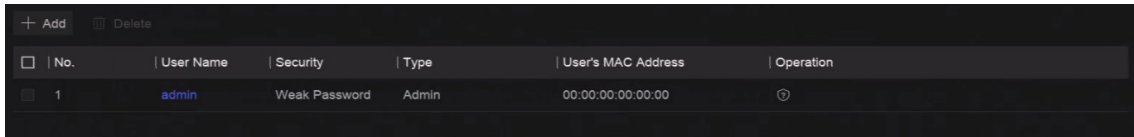



Figure 5-1 User Management

Table 5-1 Icon/Button Description

| Icon/Button | Description |
|---|-----------------------------------|
|  | Set account security. |
| Add | Add a new guest or operator user. |
|  | Delete the selected user. |

 **Note**

Before operation, you have to confirm the admin password.

Chapter 6 Device Access

The video recorder may be able to access multiple device types, such as network camera, access control device, and alarm device. Please refer to the actual device for the access capability of your video recorder.

6.1 Access Video Device

There are several ways to access a video device.

6.1.1 Add Automatically Searched Online Network Camera

Network cameras on the same network segment can be automatically searched and added to the device.

Steps

1. Go to **Desktop** → **Device Access** → **Device** → **Video Device** → **Online Device List**.
2. Select the device(s) from the list.

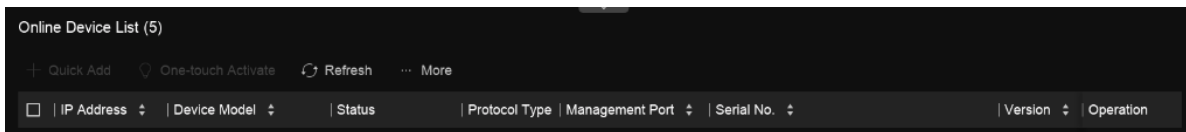

Figure 6-1 Add Automatically Searched Online Network Camera

3. Click **Quick Add**.

Note

- The device will use a default password to add network cameras, ensure the camera password is the same as the default password.
 - If the network camera to be added has not been activated, you can activate it from the camera management interface under the network camera list.
 - When a network camera is successfully added, its status would be **Online**.
 - You can click the device name to add its parameters.
-

6.1.2 Add Network Camera Manually

Manually add the network cameras to your video recorder.

Before You Start

- Ensure your network camera is on the same network segment as that of your video recorder.

- Ensure the network connection is valid and correct.
Ensure the network camera is activated.

Steps

1. Go to **Desktop** → **Device Access** → **Device** → **Video Device**.
2. Click **Add**.

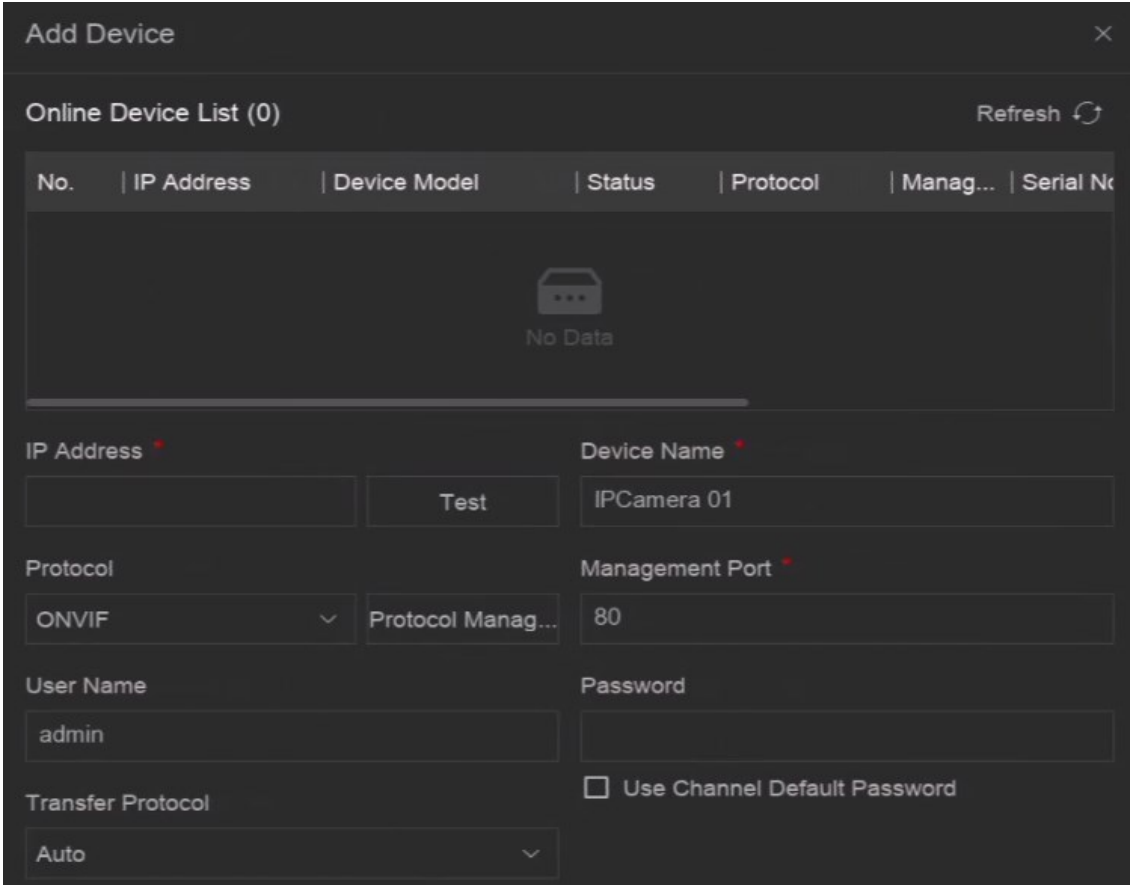

The screenshot shows the 'Add Device' configuration window. At the top, there is a title bar with 'Add Device' and a close button. Below the title bar is a section for 'Online Device List (0)' with a 'Refresh' button. The list is currently empty, showing a 'No Data' message with a camera icon. Below the list are several input fields and buttons:

- IP Address**: A text input field with a red asterisk indicating it is required.
- Device Name**: A text input field with a red asterisk, containing the value 'IPCamera 01'.
- Protocol**: A dropdown menu with 'ONVIF' selected and a 'Protocol Manag...' button next to it.
- Management Port**: A text input field with a red asterisk, containing the value '80'.
- User Name**: A text input field containing the value 'admin'.
- Password**: A text input field.
- Transfer Protocol**: A dropdown menu with 'Auto' selected.
- Test**: A button located between the IP Address and Device Name fields.
- Use Channel Default Password**: A checkbox that is currently unchecked.

Figure 6-2 Add Network Camera Manually

3. Enter network camera parameters.

Use Channel Default Password

If it is enabled, the video recorder will add the camera by the set channel default password.

More Settings

You can enable **Verify Certificate** to verify the camera with certificate. The certificate is a form of identification for the camera that provides more secure camera authentication. It requires importing the network camera certificate to the device first when you use this function.

4. Optional: Click **Continue to Add** to add other network cameras.
5. Click **Add**.

6.1.3 Add Network Camera through PoE

A PoE (Power over Ethernet) network camera can be directly connected to your device through the PoE interface at the rear panel.

After using a network cable to connect a PoE network camera with your device, you shall configure the corresponding PoE interface. Refer to [**Configure PoE \(Power over Ethernet\) Interface**](#) for details.

6.1.4 Add Solar-Powered Camera through OTAP Protocol

Solar-powered cameras can be added to your device through OTAP protocol.

Before You Start

Ensure the network between your device and solar-powered camera is accessible through OTAP protocol.

Enter the context of your task here (optional).

Steps

1. Go to **Desktop** → **Device Access** → **Device Configuration** → **Access Service** → **OTAP Service**.
2. Turn on **Enable**.
3. Set OTAP **Server Port** and **Encryption Key**.
4. Optional: Enable **Auto Add IP Camera**. After the device OTAP parameters are configured, the newly signed network cameras (through OTAP protocol) can be automatically added to your device.
5. Configure the solar-powered camera OTAP protocol parameters through web browser. Refer to the camera user manual for details.

Note

The solar-powered camera OTAP protocol parameters shall be the same as the device.

6. Add solar-powered camera(s) to your device.
 - If you have enabled **Auto Add IP Camera**, the newly signed network cameras (through OTAP protocol) would automatically be added to your device.
 - Select solar-powered camera(s) from **Online Device List** and click **Quick Add**.
7. Click **Add** in **Desktop** → **Device Access** → **Device** → **Video Device**, select **Protocol** as **OTAP**, and click **Add**.

What to do next

- After a solar-powered camera is added to your device, you can wake it up, view its battery power, view its live video, configure its parameters through web browser, etc.
- Set ANR (Automatic Network Replenishment) for the camera. Refer to [**Configure Recording Schedule**](#).

6.1.5 Add Network Camera via Custom Protocol

For network cameras that are not using standard protocols, you can configure custom protocols to add them. The system provides 8 custom protocols.

Before You Start

- Ensure the network camera supports RTSP streaming.
- Prepare the URL (Uniform Resource Locator) for getting the main stream or sub-stream of network cameras.

Steps

1. Go to **Desktop** → **Device Access** → **Device** → **Video Device**.
2. Click **More** → **Custom Protocol Management** or **Add** → **Protocol Management**.

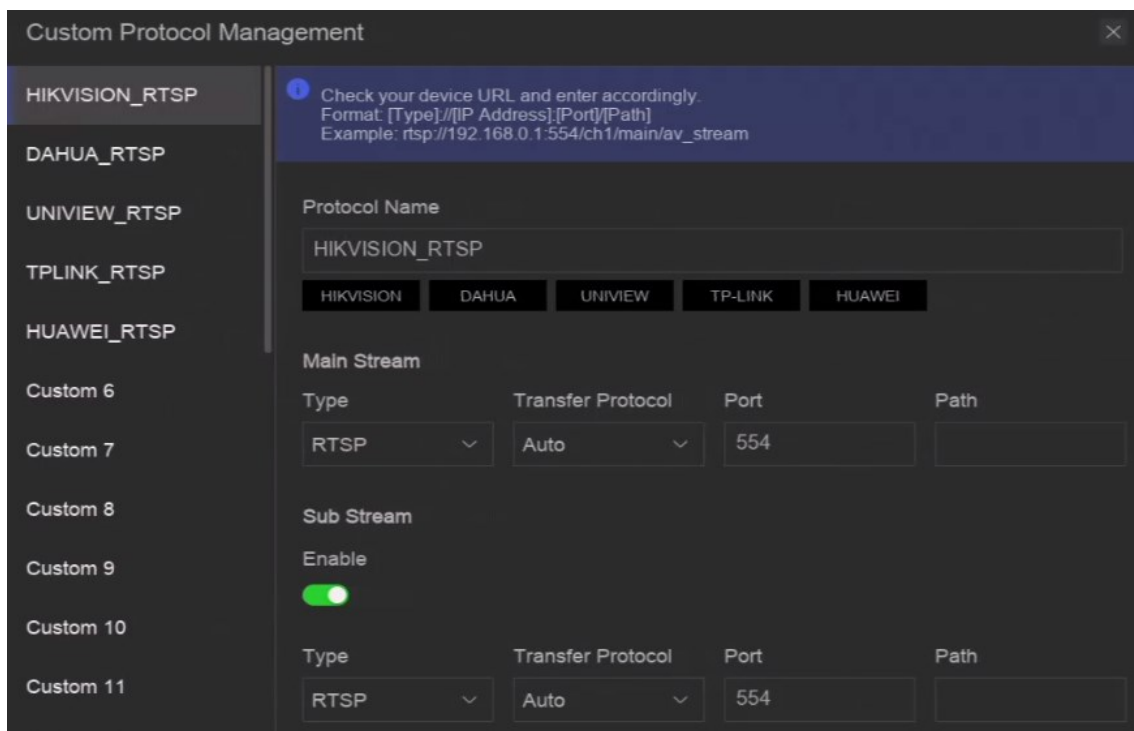

Figure 6-3 Add Network Camera via Customized Protocol

3. Select a protocol type at the left side.
4. Set protocol parameters.

Type

The network camera adopting custom protocol must support getting stream through standard RTSP.

Transfer Protocol

3 types are selectable, including **Auto**, **UDP**, and **RTP Over RTSP**.

Port

The port for RTSP streaming, its default value is 554.

Path

Contact the manufacturer of network camera for the URL of getting main stream and sub-stream. The general format is *[Type]://[IP Address]:[Port]/[Resource Path]*, for example, *rtsp://192.168.0.1:554/ch1/main/av_stream*.

Note

- **Protocol Name** and **Path** can be automatically generated if you click a brand name below **Protocol Name**.

You can disable sub-stream if the camera does not support sub-stream or does not have to use the sub-stream.

5. Click **OK**.
6. Click **Add** in **Desktop** → **Device Access** → **Device** → **Video Device** to manually add a network camera.

6.1.6 Add Network Camera through Camera Configuration File

The information of added network cameras can be exported, including the IP address, port, password of admin, etc. And the exported camera configuration file content can be edited on your computer. After editing, the file can also be imported to other devices to add the cameras in the file.

Before You Start

Connect your video recorder to a USB flash drive that contains camera configuration file in it.

Steps

1. Go to **Desktop** → **Device Access** → **Device** → **Video Device**.
2. Click **Import** to import the configuration file in USB flash drive.
3. Set the folder path.
4. Click **Confirm**.

6.2 Add Access Control Device

Access control devices can be added to your video recorder.
The adding process is similar with [Access Video Device](#).

6.3 Add Security Control Panel

Steps

1. Go to **Desktop** → **Device Access** → **Device** → **Security Control Panel**.
2. Click **Add**.
3. Optional: Select a protocol.
4. Enter device IP address, name, and IoT service port.
5. Optional: Select a transfer protocol if you select **OPTEX** as the protocol type.
6. Optional: Click  in the Operation column to set OSD parameters including character encoding, overlay mode, font size, etc.

Note

The Linked Channel cannot be edited. Go to **Event Center** → **Event Configuration** → **Event Configuration** → **Security Control Panel Event** to edit the linked channel.

OSD information you have set will be displayed on the video image.

6.4 Add Audio Device

Audio devices can be added to your video recorder, such as IP speakers, and microphones. The adding process is similar with [Access Video Device](#). If you link video channels with an IP speaker, the IP speaker could be used for voice broadcast. If you link video channels with a microphone, the microphone would be used as the audio input of the linked video channels for video recording.

6.5 Add POS Device

POS machine/server can be connected to certain device models. The device can receive transaction messages from POS machine/server, overlay transaction messages on the video image, and trigger POS event alarms.

Steps

1. Go to **Desktop** → **Device Access** → **Device** → **POS**.
2. Click **Add** to add a POS device.

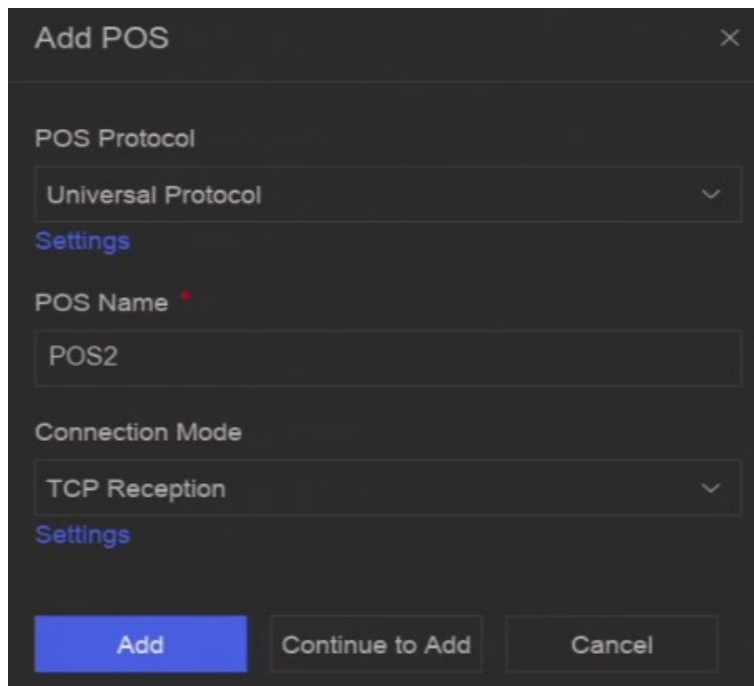

Figure 6-4 Add POS Device

3. Set the POS device parameters.

POS Protocol

Universal Protocol

You can set the start line identifier, line break tag, and end line tag for the POS overlay characters, and the case-sensitive property of the characters. You can also optionally check the filtering identifier and the XML protocol.

EPSON

The fixed start and end line tag are used for EPSON protocol.

AVE

The fixed start and end line tag are used for AVE protocol. Serial port and virtual serial port connection types are supported.

NUCLEUS

The fixed start and end line tag are used for AVE protocol. Serial port and virtual serial port connection types are supported. The NUCLEUS protocol must be used in the RS-232 connection communication.

Connection Mode

TCP Connection

When using TCP connection, the port must be set from 1 to 65535, and the port for each POS machine must be unique.

UDP Connection

When using UDP connection, the port must be set from 1 to 65535, and the port for each POS machine must be unique.

USB-to-RS-232 Connection

Configure the USB-to-RS-232 convertor port parameters, including the port serial number, baud rate, data bit, stop bit, and parity.

RS-232 Connection

Connect the device and the POS machine via RS-232.

Multicast Connection

When connecting the device and the POS machine via Multicast protocol, set the multicast address and port.

Sniff Connection

Connect the device and the POS machine via Sniff. Configure the source address and destination address settings.

4. Click **Add**.



After a POS device is added, you can click  in **Operation** to configure POS text overlay.

6.6 Channel Management

After a video device is added, you can view its channel number and channel name and manage its parameters. This function is mainly used for a video device that contains more than one channel. Go to **Desktop** → **Device Access** → **Channel** to manage channels of video devices.

Chapter 7 Device Grouping

The added devices can be classified into different customized groups.

Steps

1. Go to **System** → **Device Access** → **Device Grouping**.

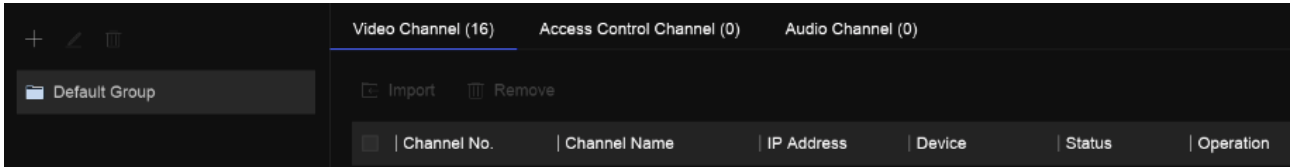



Figure 7-1 Device Grouping

2. Click **+** to add a group.

Note

After a group is added, you can click  to edit/delete it.

3. Click **Import** to add channel(s) to the selected group.

Chapter 8 Video or Audio Device Settings

You can configure the added video or audio device, such as privacy mask, image parameters, etc.

8.1 Enable H.265 Stream Access

The device can automatically switch to the H.265 stream of IP camera (which supports H.265 video format) for the initial access.

Steps

1. Go to **Desktop** → **Device Access** → **Device** → **Video Device**.
2. Click **More** → **Add Auto Switch to H.265**.
3. Enable this function.
4. Click **Save**.

8.2 Configure Display Settings

Configure the OSD (On-Screen Display), image settings, exposure settings, day/night switch settings, etc.

Go to **Desktop** → **Device Access** → **Device Configuration** → **Device Parameter** → **Video Device** → **Display Settings**. Select a camera and configure parameters as your desire.

OSD Settings

Configure the OSD (On-screen Display) settings for the camera, including display content, date/time format, display mode, etc.

Image Settings

Customize the image parameters including the brightness, contrast, and saturation for the live view and recording effect.

Exposure Time

Set the camera exposure time (1/10000 to 1 sec). A larger exposure value results in a brighter image.

Day/Night Switch

The camera can be set to **day**, **night**, or **auto switch** mode according to the surrounding illumination conditions.

Backlight

Set the camera's wide dynamic range (0 to 100). When the surrounding illumination and the object have large differences in brightness, you should set the WDR value.

Image Enhancement

For optimized image contrast enhancement.

8.3 Configure Video Parameters

Video parameters would affect the live view image and recording file.

Go to **Desktop** → **Device Access** → **Device Configuration** → **Device Parameter** → **Video Device** → **Video Parameters**. Select a camera and configure parameters as your desire.

Main Stream

Main stream refers to the primary stream that affects data recorded to the hard disk drive and will directly determine your video quality and image size. Comparing with the sub-stream, the main stream provides a higher quality video with higher resolution and frame rate.

Sub-Stream

Sub-stream is a second codec that runs alongside the mainstream. It allows you to reduce the outgoing internet bandwidth without sacrificing your direct recording quality. Sub-stream is often exclusively used by smartphone applications to view live videos. Users with limited internet speeds may benefit most from this setting.

Resolution

Image resolution is a measure of how much detail a digital image can hold. The greater the resolution, the greater the level of detail. Resolution can be specified as the number of pixel-columns (width) by the number of pixel-rows (height), e.g., 1024 × 768.

Bitrate Type

The bit rate (in kbit/s or Mbit/s) is often referred to as speed but defines the number of bits/time unit rather than distance/time unit. Two types including variable or constant are available.

Frame Rate

It refers to the number of frames captured each second. A higher frame rate is advantageous when there is movement in the video stream, as it maintains image quality throughout.

I-Frame Interval

I-Frame also referred as intra picture, I-Frame is the first frame of every GOP (a video compression technology of MPEG). It can be viewed as pictures after compression. I-Frame interval is the amount of frames between two continuous I-Frames.

8.4 Configure Privacy Mask

Privacy mask protects personal privacy by concealing parts of the image from live view or

recording with a masked area.

Steps

1. Go to **Desktop** → **Device Access** → **Device Configuration** → **Device Parameter** → **Video Device** → **Privacy Mask**.

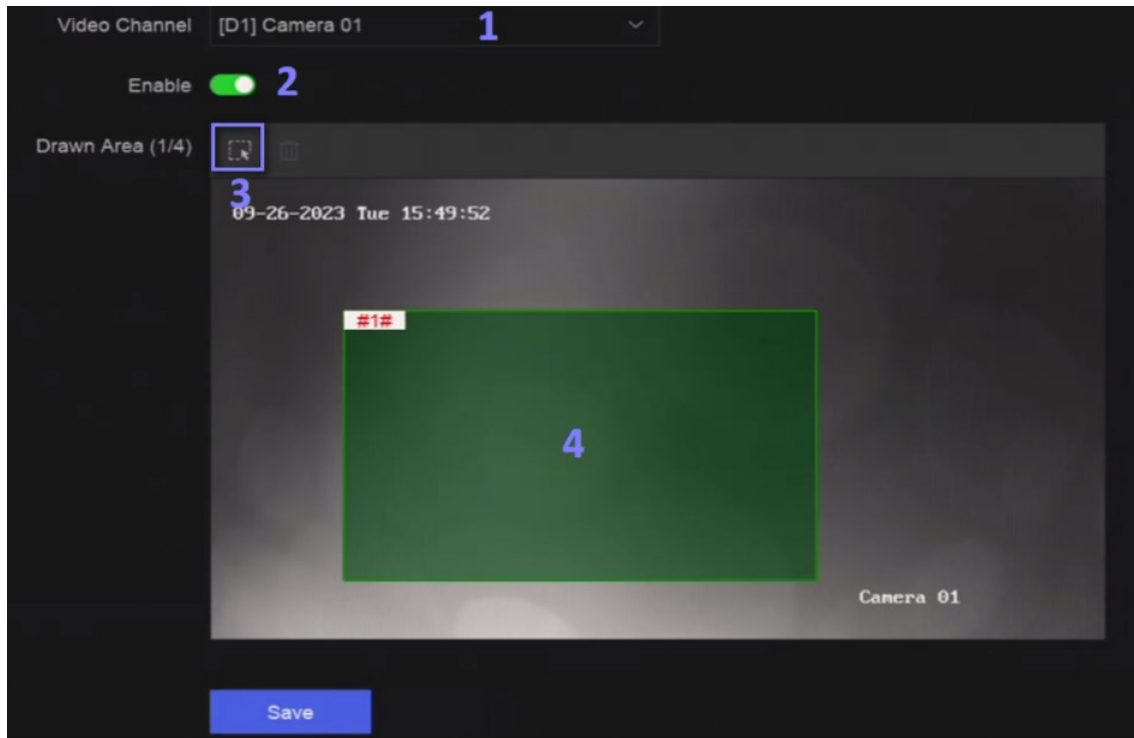

Figure 8-1 Privacy Mask

2. Select a camera.
3. Turn on **Enable**.
4. Draw mask areas on the preview window. The areas will be marked with different frame colors.

Note

Up to 4 privacy mask areas can be configured and the size of each area can be adjusted.

5. Click **Save**.

8.5 Configure Privacy Protection

This function allows for the automatic obscuring or blurring of specific areas (including human faces, human bodies, and vehicles) on the video footage to protect personal privacy or sensitive

information.

Before You Start

This function should be supported by the camera.

Steps

1. Go to **Desktop** → **Device Access** → **Device Configuration** → **Device Parameter** → **Video Device** → **Privacy Protection**.

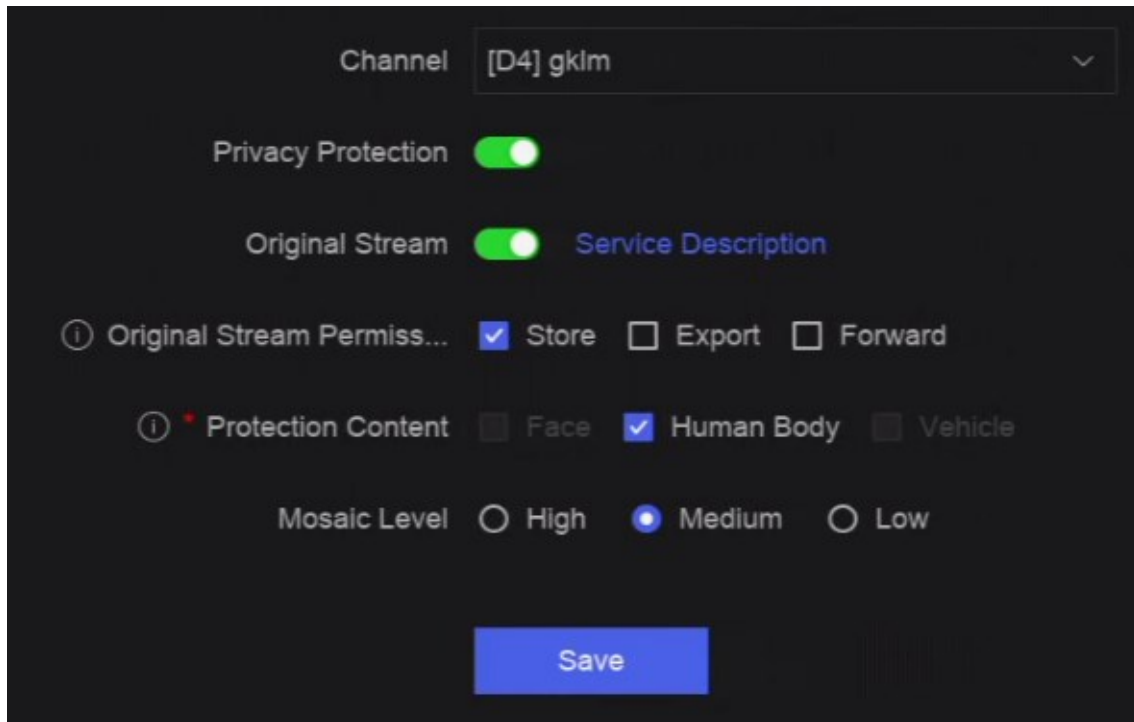

Figure 8-2 Privacy Protection

2. Select a camera.
3. Enable **Privacy Protection**.
4. Optional: Enable **Original Stream** and set the stream permission.

Note

Original stream means the video stream without mosaic.

Store

The original stream can be stored. Storing original stream will cost more storage space or decrease the recording storage period of the channel. The original stream bitrate is the same as the camera, which is not configurable.

Export

The channel original stream can be exported.

Forward

The original stream can be forwarded.

Note

You should check Store permission before checking Export and/or Forward permissions.

5. Set **Protection Content**. The selected protection content will be blurred during live view and playback.
6. Set **Mosaic Level**. Higher the level, more blurred the target image.
7. Click **Save**.

8.6 Configure Audio Parameter

After an audio device is added, you can configure its parameters in **Desktop** → **Device Access** → **Device Configuration** → **Device Parameter** → **Audio Device**. For example, if an IP speaker is added, its name, audio output volume and audio quality can be configured.

8.7 Configure OTAP Service

OTAP (Open Thing Access Protocol) is a unified integrated standard and push-pull mode of LTS Connect protocol in the public network and private network. After OTAP is enabled, other applications may be able to remotely view videos through this protocol.

Before You Start

Ensure your device network is accessible through OTAP protocol.

Steps

1. Go to **Desktop** → **Device Access** → **Device Configuration** → **Access Service** → **OTAP Service**.

| | |
|-----------------------------|-------------------------------------|
| Enable | <input checked="" type="checkbox"/> |
| Service Port | 7800 |
| Encryption Key | |
| Auto Add IP Camera | <input checked="" type="checkbox"/> |
| Enable External Mapping | <input checked="" type="checkbox"/> |
| External IP Address | 0.0.0.0 |
| External Service Port | 7800 |
| External Alarm Port | 7700 |
| External Alarm Picture ... | 6011 |
| External Streaming Start... | 58002 |

Save

Figure 8-3 Configure OTAP Service

2. Turn on **Enable**.
3. Set the parameters.
4. Click **Save**.

8.8 Batch Configuration

Connected devices can be configured in a batch.

Steps

1. Go to **Desktop** → **Device Access** → **Device Configuration** → **Batch Configuration**.

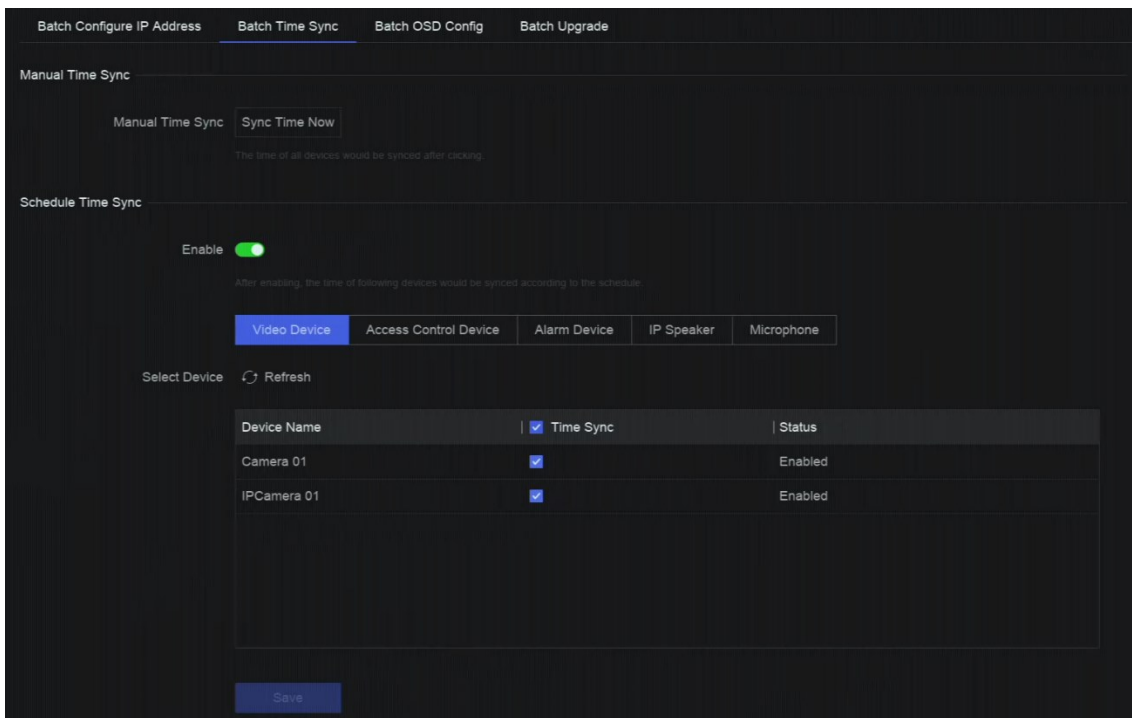

Figure 8-4 Batch Configuration

2. Configure IP address, time sync, OSD, or upgrade firmware as your desire.

Manual Time Sync

Click **Sync Time Now** to manually sync time of all connected devices. This operation is just for once.

Schedule Time Sync

The recorder would sync time of the selected devices according to a fixed schedule.

3. For IP address configuration and time sync, click **Save**.

8.9 Configure PoE (Power over Ethernet) Interface

The PoE interfaces enable the device to transfer electrical power and data to connected PoE devices. And the PoE interface supports the Plug-and-Play function. Connectable PoE device number varies with device models. If you disable a PoE interface, you can also use it to connect to an online device.

Before You Start

Ensure your NVR supports PoE function.

Steps

1. Go to **Desktop** → **Device Access** → **Device Configuration** → **PoE Settings**.
2. Enable **Network Camera Plug-and-Play** function of PoE interfaces according to your requirements.

3. Select the device type as **IP Speaker** or **Camera**.
4. If a PoE interface is used to connect to a PoE camera, select the connection distance of network cable.

Long Distance

Long-distance (100 to 300 meters) network transmissions via PoE interface.

Short Distance

Short-distance (< 100 meters) network transmission via PoE interface.

Note

- The PoE interfaces are enabled with the short distance mode by default.
 - The bandwidth of IP camera connected to the PoE via long network cable (100 to 300 meters) cannot exceed 6 MP.
 - The allowed max. long network cable may be less than 300 meters depending on different IP camera models and cable materials.
 - When the transmission distance reaches 100 to 250 meters, you must use the CAT5E or CAT6 network cable to connect with the PoE interface.
 - When the transmission distance reaches 250 to 300 meters, you must use the CAT6 network cable to connect with the PoE interface.
-

5. Click **Save**.

What to do next

When PoE devices are connected, you can view the status and power of each PoE interface.

Chapter 9 Storage Management

9.1 Manage HDD

A newly installed hard disk drive (HDD) must be initialized before using. You can format HDD, repair database, and view HDD status through HDD management interface.

Before You Start

Ensure the HDD is properly installed to your device.

Steps

1. Go to **Desktop** → **Storage Management** → **Storage HDD** → **Storage HDD**.

| HDD No. | Free Space (GB) | Capacity (GB) | Status | Type | Property | Operation |
|---------|-----------------|---------------|----------|-------|----------|-----------|
| 1 | 166 | 466 | Sleeping | Local | R/W | [Icon] |
| 3 | 3685 | 3726 | Sleeping | Local | R/W | [Icon] |
| 5 | 3685 | 3726 | Sleeping | Local | R/W | [Icon] |

Figure 9-1 Manage HDD

2. Optional: Perform the following operations as your desire.

Add Network HDD Add a NAS or IP SAN.

Format Format the selected HDD.

Repair Database Repairing database will rebuild all databases. It might help to improve your system speed after upgrade.

Note

- Repairing database will rebuild all databases. Existing data will not be affected, but local search and playback functions will not be available during the process, you can still achieve search and playback functions remotely via web browser, client software, etc.
- Do not pull out the drive, or shut down the device during the process.



Remove/load HDD.

9.2 RAID Configuration

A disk array is a data storage virtualization technology that combines multiple physical disk drives into a single logical unit. Also known as a "RAID", an array stores data over multiple HDDs to provide enough redundancy so that data can be recovered if one disk fails. Data is distributed across the drives in one of several ways called "RAID levels", based the redundancy and performance required.

Caution

RAID requires enterprise-level HDDs.

The functions in this section are only available for certain models. It is recommended to use the same model and capacity HDDs.

There are two ways to create RAID. For one-touch creation, the default RAID type is RAID5. For manual creation, RAID0, RAID1, RAID5, RAID6, and RAID10 can be configured.

Table 9-1 HDD Requirement for Each RAID Type

| RAID Type | Required Number of HDDs |
|-----------|-------------------------|
| RAID0 | ≥2 |
| RAID1 | 2 |
| RAID5 | ≥3 |
| RAID6 | ≥4 |
| RAID10 | 4 or 8 |

Note

- The function is only available for certain models.
- When array exception event occurs, the corresponding linkage actions can be configured in **Desktop → System Settings → Exception**.

9.2.1 Create Disk Array

A disk array can be created after enabling array mode.

Before You Start

- **Storage Mode** is set to **Quota** in **Desktop → Storage Management → Storage Mode**.
- Enough HDDs are correctly installed to the device. And HDDs for array creation are AI or enterprise level.

Steps

1. Go to **Desktop** → **Storage Management** → **Storage HDD** → **Array Management**.
2. Click **Enable Array Mode** or enable **Array Mode**.

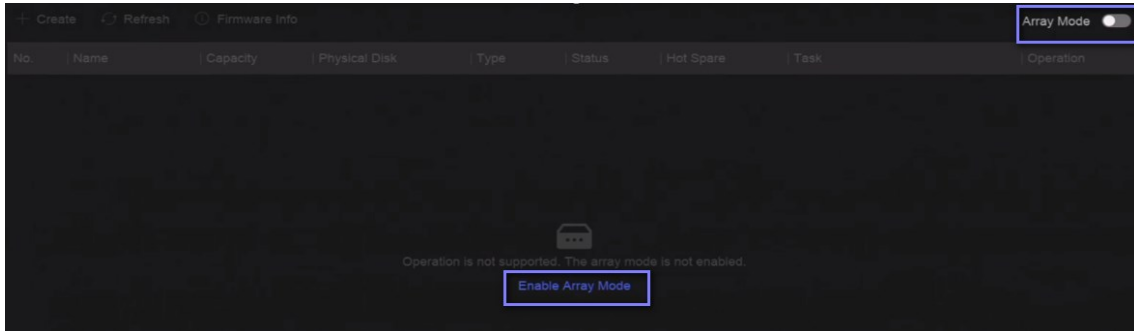

Figure 9-2 Enable RAID

3. Wait for the device to restart.
4. Go to **Desktop** → **Storage Management** → **Storage HDD** → **Array Management** again.

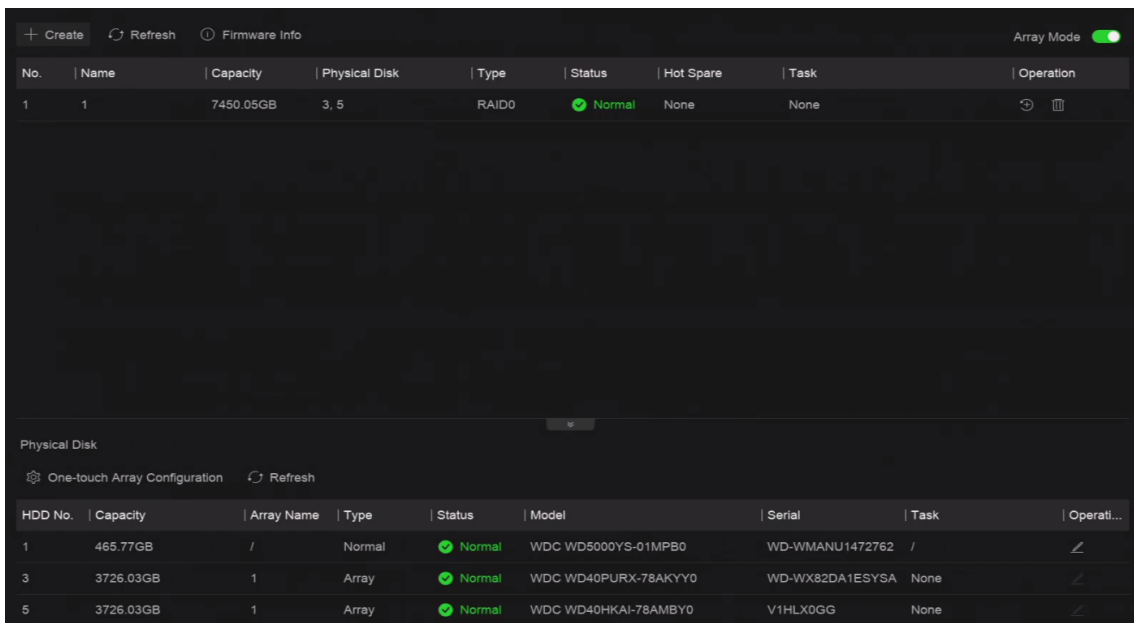

Figure 9-3 Array Management

5. Create an array.

Creation Method

Description

One-touch Array Configuration

Click **One-touch Array Configuration**.

Note

By default, the array type created by one-touch configuration is RAID 5.

Manual Creation Click **Create** to manually create a RAID 0, RAID 1, RAID 5, RAID 6, or RAID 10 array.



9.2.2 Rebuild Array

The array status includes **Functional**, **Degraded**, and **Offline**. To ensure the high security and reliability of the data stored in an array, take immediate and proper maintenance of the arrays according its status.

Steps

1. Go to **Desktop** → **Storage Management** → **Storage HDD** → **Array Management**.
2. Rebuild an array.

Table 9-2 Rebuilding Method

| Rebuilding Method | Description |
|-------------------|---|
| Auto Rebuild | <p>There should be a hot spare disk in the array, and the hot spare disk capacity is not less than the disk with the minimum capacity in the array. Click  in Operation column under Physical Disk to set a hot spare disk.</p> <p>When an HDD in the array in the array is not working, the hot spare disk would be activated, and the array would be automatically rebuilt.</p> <hr/> <p> Note</p> <p>After auto rebuild finishes, it is recommended to install another HDD, and configure it as the hot spare disk.</p> <hr/> |
| Manual Rebuild | <p>If there is no hot spare disks in the array, you have to manually rebuild the array.</p> <p>Go to Desktop → Storage Management → Storage HDD → Array Management, and select the hot spare disk in the list to rebuild.</p> |

9.2.3 Delete Array

Go to **Desktop** → **Storage Management** → **Storage HDD** to click  to delete the selected array.

9.2.4 View Firmware Info

You can view array firmware information and set the background task speed.

Before You Start

Ensure disk array is enabled.

Steps

1. Go to **Desktop** → **Storage Management** → **Storage HDD** → **Array Management**.
2. Click **Firmware Info**.
3. Optional: Set **Back Ground Task Speed**.

9.3 Configure Storage Mode

Steps

1. Go to **Desktop** → **Storage Management** → **Storage Mode**.

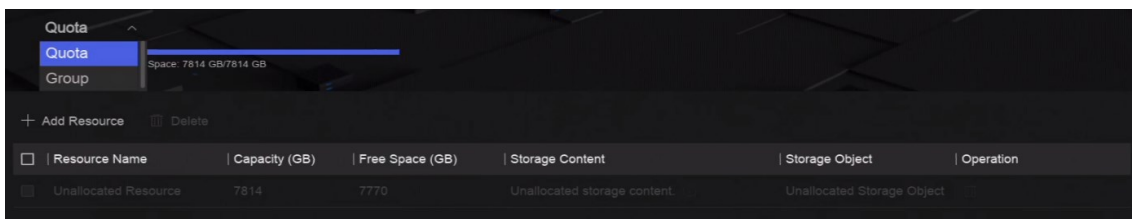

Figure 9-4 Storage Mode

2. Select **Quota** or **Group**.

Quota

Each camera or audio device can be configured with an allocated quota for storing videos, pictures, or audios.

Group



Multiple HDDs can be managed in groups. Video from specified channels can be recorded onto a particular HDD group through HDD settings.

3. Set corresponding parameters.
 - **Quota**: Allocate space for storage objects.
 - **Group**: Link channels to HDD groups.

9.4 Configure Other Storage Parameters

Go to **Desktop** → **Storage Management** → **Advanced Settings**.

Table 9-3 Parameter Description

| Parameter Name | Description |
|-----------------------|---|
| HDD Sleeping | Select a mode for HDDs. Performance Mode , Balanced Mode , and Energy Saving Mode are selectable. |
| Overwriting | When HDD is full, it will continue to write new files by deleting the oldest files. |
| Save Camera VCA Data | After saving VCA data of camera to your device, you will be able to search it in Event Center . |
| Max. Length per Video | It is the time length of each video file when you are exporting videos from the device. |
| Tag Video Post-Record | <p>After adding a tag to a video, it is the time you set to record after the scheduled time.</p> <hr/> <p> Note</p> <ul style="list-style-type: none"> • You can click  during live view or playback to add a tag. • For searching tag videos, go to  → Backup → By Tag. <hr/> |
| eSATA | For devices with eSATA interface at the rear panel. |
| Usage | Set the usage for eSATA. |

9.5 Mange USB Flash Drive

After inserting a USB flash drive into your device, you can view its remaining storage capacity, manage its content, or format it.

When a USB flash drive is connected to your device for the first time, short operations can be performed, such as device upgrade and backup. Meanwhile, there would be a new icon  displayed at the upper-right corner.

Chapter 10 Schedule Configuration

The device will follow the schedule to store files on the disk.

10.1 Configure Schedule Template

After a schedule template is configured, you can use the template as the recording schedule.

Steps

1. Go to **Desktop** → **System Settings** → **Template Configuration** → **Holiday Schedule**.
2. Click **Add**.

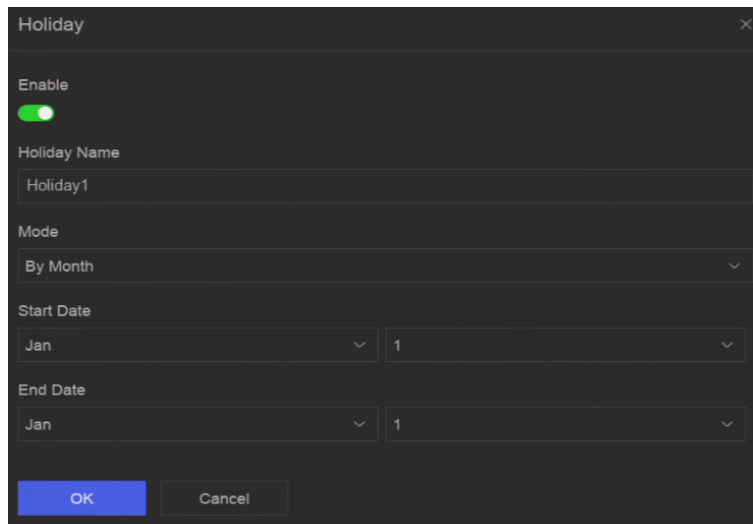

Figure 10-1 Add Holiday

3. Turn on **Enable**.
4. Configure the holiday.

Note

After holidays are configured, you will be able to set the holiday schedule independently. Holiday schedule has higher priority than normal schedule (from Mon to Sun).

5. Set **Storage Schedule**.
 - 1) Click **Storage Schedule**.
 - 2) Select a template name.

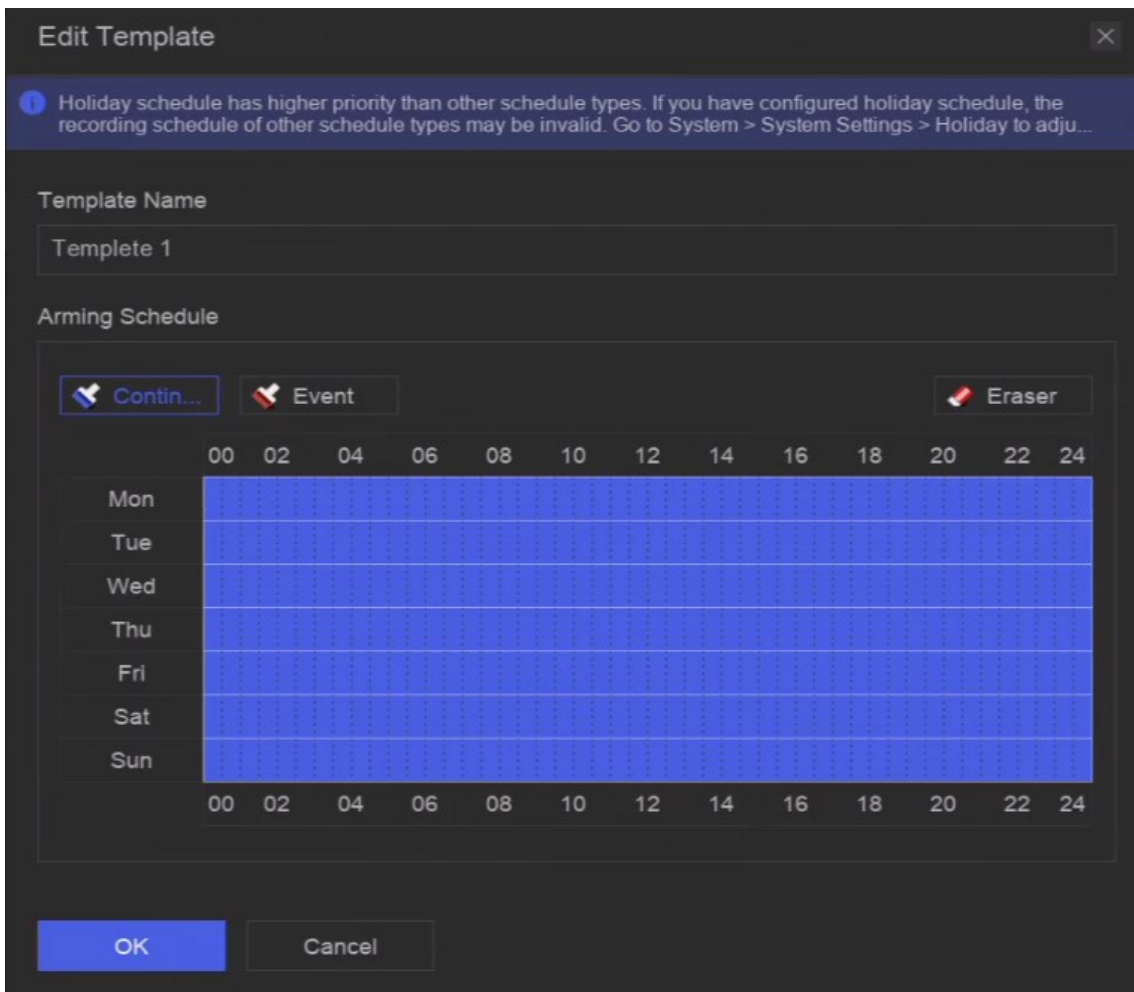



Figure 10-2 Edit Template

- 3) Select a recording type. For example, **Event**.
- 4) Drag the cursor on time bar to draw the schedule.

 **Note**

- After moving the cursor on time bar, you can also click **00:00-24:00**  to set specified time schedule.
- You can click **Eraser** to clear schedule.

 **Note**

You can also click **Configure Template** to configure template in **Desktop** → **Storage Management** → **Storage Schedule** → **Video Recording / Picture Capture / Audio Recording**.

6. Click **OK**.

10.2 Configure Recording Schedule

The camera would automatically start/stop recording according to the configured recording schedule.

Steps

1. Go to **Desktop** → **Storage Management** → **Storage Schedule** → **Video Recording**.

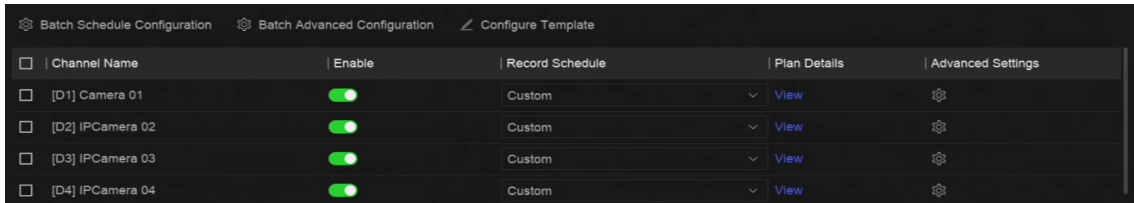

| Channel Name | Enable | Record Schedule | Plan Details | Advanced Settings |
|------------------|-------------------------------------|-----------------|----------------------|-------------------|
| [D1] Camera 01 | <input checked="" type="checkbox"/> | Custom | View | |
| [D2] IPCamera 02 | <input checked="" type="checkbox"/> | Custom | View | |
| [D3] IPCamera 03 | <input checked="" type="checkbox"/> | Custom | View | |
| [D4] IPCamera 04 | <input checked="" type="checkbox"/> | Custom | View | |

Figure 10-3 Video Recording Configuration

2. Turn on **Enable** for a camera.
3. Select a schedule type.

Note

If you set **Record Schedule** as **Custom**, you can drag the cursor on time bar to set customized record schedule or move the cursor on time bar and click **00:00-24:00**  to set specified time schedule.

4. Set **Record Schedule** as **Custom** and Click **View** to view the schedule.



Figure 10-4 View Schedule

5. Optional: Click  under **Advanced Settings** to set other advanced parameters.

Table 10-1 Advanced Parameter Description

| Parameter | Description |
|--------------|---|
| Record Audio | <p>Enable or disable audio recording.</p> <hr/> <p> Note The channel shall have audio function or have connected an audio device.</p> <hr/> |
| ANR | ANR (Automatic Network Replenishment) can automatically enable SD card of network camera to save the video in the condition of network disconnection, and can synchronize data after the network is recovered. |
| Pre-Record | The time you set to record before the scheduled time or event. For example, when an alarm triggers the recording at 10:00, and if you set the pre-record time as 5 seconds, the camera records at 9:59:55. |

| Parameter | Description |
|----------------------------|--|
| Post-Record | The time you set to record after the event or the scheduled time. For example, when an alarm triggered recording ends at 11:00, and if you set the post-record time as 5 seconds, it records till 11:00:05. |
| Stream Type | For Main Stream , its resolution is usually higher. For Sub-Stream , you can record for a longer time with the same storage space, but its resolution would be low. For Dual Stream , the device will record both main stream and sub-stream. |
| Video/Picture Expired Time | The expired time is period for a file to be kept in the HDD. When the deadline is reached, the file will be deleted. If you set the expired time to 0, the file will not be deleted. The actual keeping time for the file should be determined by the capacity of the HDD. |

- Optional: Select channels in the list and use **Batch Schedule Configuration** and **Batch Advanced Settings** to configure channels in a batch.
- Click **Save**.

10.3 Configure Picture Capture Schedule

The device would automatically capture live pictures according to the schedule.

Steps

- Go to **Desktop** → **Storage Management** → **Storage Schedule** → **Picture Snapshot**.

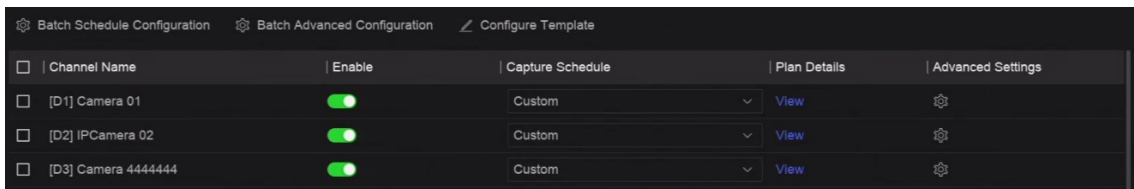

Figure 10-5 Picture Capture Configuration

- Turn on **Enable** for a camera.
- Select a schedule type.

Note

If you set **Snapshot Schedule** as **Custom**, you can drag the cursor on time bar to set customized picture capture schedule or move the cursor on time bar and click **00:00-24:00** to set specified time schedule.

- Click **View** to view the schedule.



Figure 10-6 View Schedule

5. Click under **Advanced Settings** to set advanced picture parameters.

Table 10-2 Advanced Parameter Description

| Parameter | Description |
|---------------------|---|
| Snapshot Delay Time | The duration for picture capture. |
| Resolution | Set the resolution of the picture to capture. |
| Picture Quality | Set the picture quality to low, medium or high. High picture quality requires more storage space. |
| Interval | The time interval of capturing each live picture. |

6. Optional: Select channels in the list and use **Batch Schedule Configuration** and **Batch Advanced Settings** to configure channels in a batch.
7. Click **Save**.

10.4 Configure Audio Recording

The device would automatically record audios according to the configured recording schedule.

Steps

1. Go to **Desktop** → **Storage Management** → **Storage Schedule** → **Audio Recording**.
2. Turn on **Enable** for a channel.
3. Select a schedule type.

Note

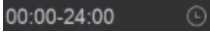
If you set **Audio Schedule** as **Custom**, you can drag the cursor on time bar to set customized record schedule or move the cursor on time bar and click  to set specified time schedule.

4. Click **View** to view the schedule.
5. Optional: Click under **Advanced Settings** to set other advanced parameters.

Table 10-3 Advanced Parameter Description

| Parameter | Description |
|-------------|---|
| Pre-Record | The time you set to record before the scheduled time or event. For example, when an alarm triggers the recording at 10:00, and if you set the pre-record time as 5 seconds, the channel records at 9:59:55. |
| Post-Record | The time you set to record after the event or the scheduled time. For example, when an alarm triggered recording ends at 11:00, and if you set the post-record time as 5 seconds, it records till 11:00:05. |



6. Optional: Select channels in the list and use **Batch Schedule Configuration** and **Batch Advanced Settings** to configure channels in a batch.
7. Click **Save**.

Chapter 11 Live View

11.1 Configure Live View Layout

Live view displays the video image of each camera in real time.

Steps

1. Go to **Live View**.
2. Click  at the lower-right corner.
3. Select a window division type or click **Custom** to customize a new type as your desire.
4. Move the cursor on **Default View** in **View**.
5. Click  at the right side of **View**.
6. Follow the step descriptions to adjust the live view image output interface. Besides the two ways that are mentioned on the user interface, you can drag a channel from one window to another.
7. Click .

11.2 GUI Introduction

You can view live images, play live audio, capture pictures, perform instant playback, etc.

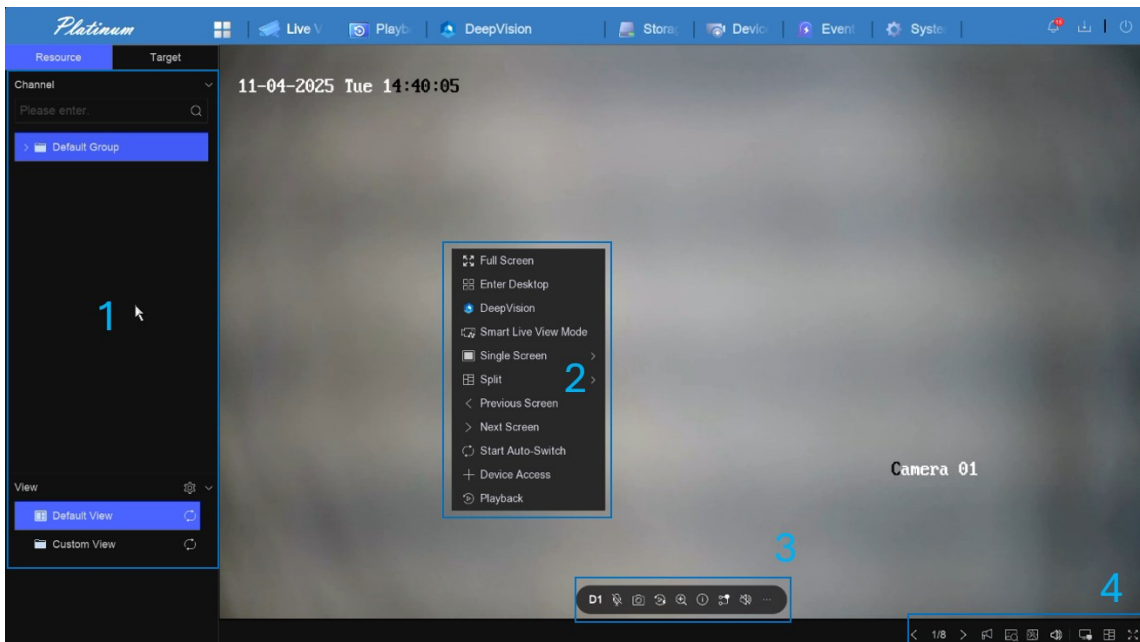





Figure 11-1 Live View

Table 11-1 Interface Description

| No. | Description |
|-----|---|
| 1 | Channel list, PTZ control panel, and target detection list. If you select a channel from the channel list, the device will redirect to the corresponding window. If you click Target , you can view live target detection results in the list, and click  to configure the corresponding settings. |
| 2 | Right-click shortcut menu. It will appear after right clicking the cursor on the image area. |
| 3 | Channel tool bar. <ul style="list-style-type: none"> Click  to add a tag go the channel. After adding, you can go to  → Backup → Video File → By Tag to search videos by tag. You can select  → Show VCA Info to display rule frames. |
| 4 | Live view tool bar. Functions like Voice Broadcast , Direct Search , Display VCA Info and Switch Output can be performed here. |

 **Note**



- You can scroll up/down your mouse to turn to previous/next screen.
- If channel image display exception occurs, the corresponding window would show the error message, and you can directly click the text (in blue color) to edit the device settings.





11.3 PTZ Control

PTZ is the acronym for Pan, Tilt, and Zoom. After a PTZ camera is add to your device, the device would be allowed to pan left and right, tilt up and down, and zoom in and out.

Select a PTZ camera and expand the PTZ control menu at the lower-left corner.

Table 11-2 PTZ Operation

| Task | Description | Operation |
|--------|--|---|
| Preset | Presets record the PTZ position and the status of zoom, focus, iris, etc. You can call a preset to quickly move the camera to the predefined position. | Set a preset: <ol style="list-style-type: none"> 1. Select a preset. 2. Use to direction buttons to adjust the image. 3. Click . |
| | | Call a preset: Click  . |

| Task | Description | Operation |
|---------|--|--|
| Patrol | Patrols can be set up to move the PTZ to key points and have it stay there for a set duration before moving on to the next key point. The key points are corresponding to the presets. | Set a patrol: 1. Select a patrol. 2. Click  3. Add presets for the patrol. 4. Click OK . |
| Pattern | Patterns can be set by recording the movement of the PTZ. You can call the pattern to make the PTZ move according to the predefined path. | Set a pattern: 1. Click  2. Use direction buttons to adjust the image, the device will record the movement. 3. Stop recording. |
| | | Call a patrol: Click  . Call a pattern: Click  . |

 **Note**

If the PTZ panel cannot be used, please click  to check the settings.

Chapter 12 Playback

12.1 GUI Introduction

You can play back video or audio files.

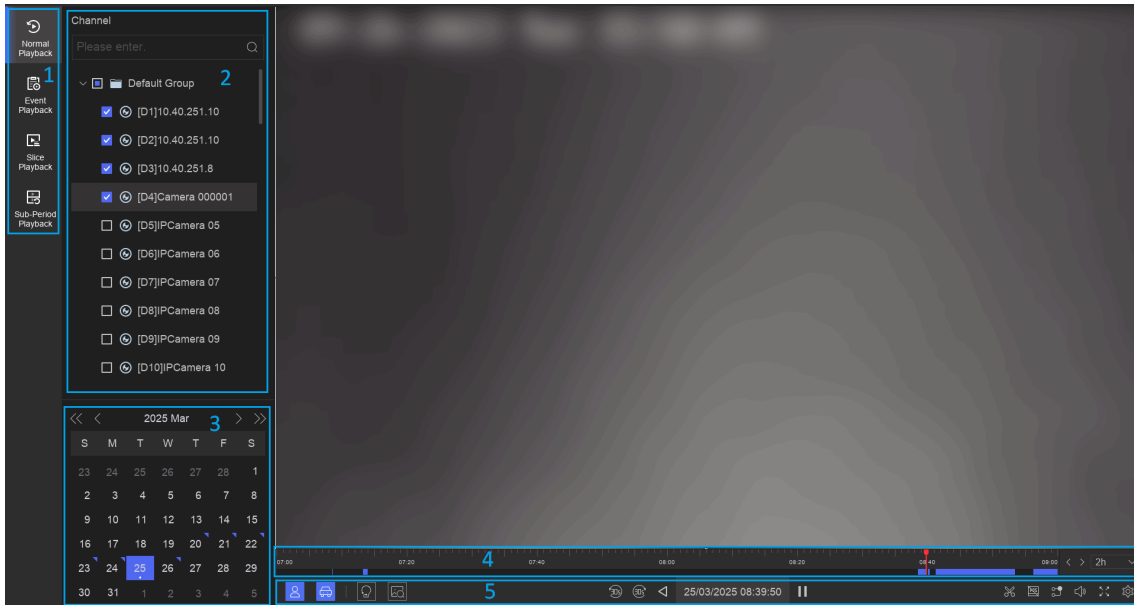







Figure 12-1 Playback

Table 12-1 Interface Description

| No. | Description |
|-----|--|
| 1 | Area for selecting playback type. |
| 2 | Channel list. |
| 3 | Calendar for time selection. |
| 4 | Playback timeline. <ul style="list-style-type: none"> ● Position the cursor on the timeline, drag the timeline to position to a certain time. ● Period marked with blue bar contains video. Red bar indicates the video in the period is event video. ● Scroll up/down to zoom out/in timeline. |
| 5 | Playback tool bar. |

| No. | Description |
|-----|---|
| | <ul style="list-style-type: none"> ● Click  (Smart Search), then follow the pop-up tips to draw event rule and search videos that can trigger the corresponding event rule. The operations are similar with Dual-VCA function. ● Click  to perform Direct Search function. Refer to <i>Direct Search</i> for details. ● Click  to show videos that contain human/vehicle. <hr/> <p> Note</p> <p>To use this function, ensure you have configured Detection Target as Human or Vehicle for certain event types.</p> <hr/> <ul style="list-style-type: none"> ● Click , select channels, and set the start and end time to clip the video in the selected channels within specific time period. ● Click  to set normal video and smart video (the video that contains smart data) playback strategy. |

12.2 Normal Playback

Play back videos for a channel. For certain devices, synchronous playback may be allowed for several channels.

Steps

1. Go to **Playback** → .
2. Select channel(s) in the list at the left side.

Note









Group playback: Select a group in the list, and channels in the group can be played back.

3. Select a date in the calendar.

Note



The blue triangle at the calendar date corner indicates there are available videos.

4. Optional: Perform more operations.

- Capture** Click  to capture pictures during playback.
- Digital Zoom** Click  to zoom in a certain part of the video image.
-  Click  to add a tag to the channel. After adding, you can go to  → **Backup** → **Video File** → **By Tag** to search videos by tag.
-  Click  to lock the video. After a video is locked, it will not be overwritten. After locking, you can go to  → **Backup** → **Video File** → **By Tag** to search videos by lock.
- Dual-VCA** Select  → **Dual-VCA** to search videos that can trigger the corresponding event rule. Refer to the event configuration steps for details of each event type.

 **Note**

To use this function, go to **Configuration** → **Device Access** → **Device Configuration** → **Device Parameter** → **Display Info. on Stream** to turn on **Enable Dual-VCA** via web browser, and go to **System** → **Storage Management** → **Advanced Settings** to turn on **Save Camera VCA Data** via local GUI interface.

- Show VCA Info** You can select  → **Show VCA Info** to display rule frames.
- Disable Privacy Protection** If privacy protection is enabled, the image may contain mosaics. You can select  → **Display Privacy Protection** to display the original video (without mosaics) if the storage permission of privacy protection is enabled as well. Refer to [Configure Privacy Protection](#) for details about privacy protection function.

12.3 Event Playback

When you select the event playback mode, the system will analyze and mark videos that contain motion detection, line crossing detection, or intrusion detection information

Before You Start



- Ensure the camera has enabled **Dual-VCA**. You can enable it via the camera web browser interface in **Configuration** → **Video/Audio** → **Display Info. on Stream**.
- Ensure your video recorder has enabled **Save Camera VCA Data** in **Storage management** → **Advanced Settings**.

Steps

1. Select **Playback** → .
2. Select a date in the calendar.

Note

The blue triangle at the calendar date corner indicates there are available videos.

3. Click  → **Dual-VCA** at the lower-right corner of playback image to select an event type. Refer to the event configuration steps for details of each event type.
4. Click **Search**.
Videos meet the detection rule requirement will be marked in red.
5. Click  to set normal video and smart video (the video that contains smart data) playback strategy.



Note

If **Dual-VCA** is not used, red segments in progress bar means the smart videos are generated by the original event.

12.4 Slice Playback

Divide the video into slices and play them back.

Steps

1. Go to **Playback** → .
2. Select a camera from the camera list.
3. Select a date on the calendar.
4. Click **Search**.
The retrieved video will be divided into one-hour slices for playback.
5. Optional: Select a one-hour slice and click  to divide it into one-minute slices for playback.

12.5 Sub-Period Playback

The video files can be played in multiple sub-periods simultaneously on the screen.

Steps

1. Go to **Playback** → .
2. Select a camera.
3. Set the start time and end time.
4. Click **Search**.

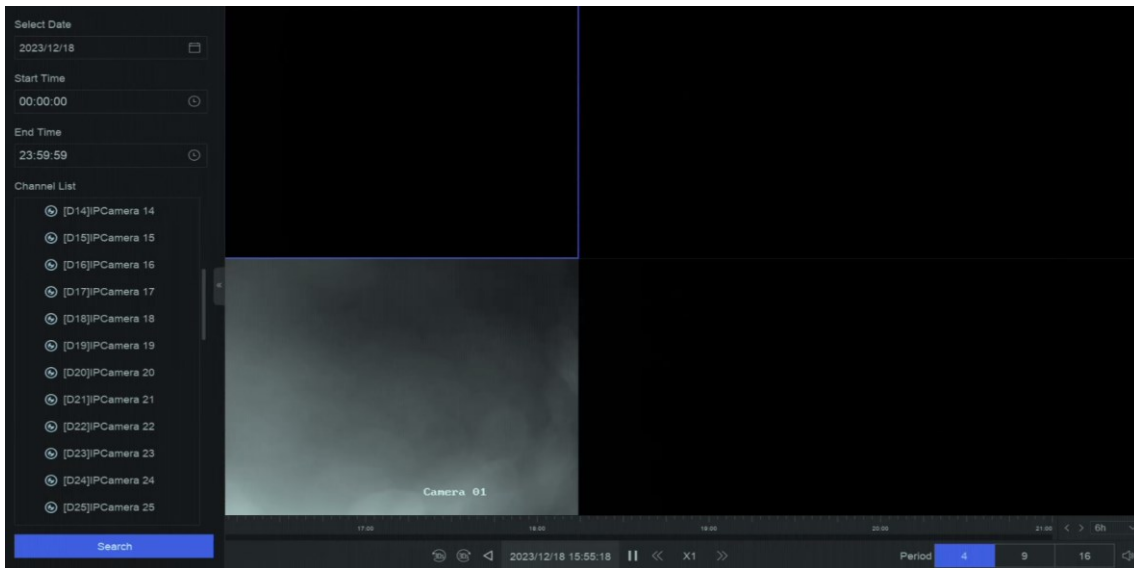

Figure 12-2 Sub-Period Playback

5. Select the period at the lower-right corner, e.g., 4.

 **Note**

According to the defined number of split-screens, the video files on the selected date can be divided into average segments for playback. E.g., if there are video files existing between 16:00 and 22:00, and the 6-screen display mode is selected, then it can play the video files for 1 hour on each screen simultaneously.

Chapter 13 Event Center

13.1 Event Settings

13.1.1 Basic/Generic Event

Steps

1. Go to **Event Center** →  → **Event Configuration** → **Basic Event / Generic Event**.
2. Select a channel.
3. Select a sub event type.
4. Turn on **Enable**.
5. Click **Rule Settings** to set the rule.

Table 13-1 Normal Event

| Event Name | Event Description | Rule Configuration | |
|---------------------------|--|---|--|
| Motion Detection | Motion detection detects the moving objects in the monitored area. | Use the tool bar at the top of image to draw the detection area. <ul style="list-style-type: none"> ● AI by Camera: The motion detection event will be analyzed by camera. ● Detection Target: Human and Vehicle are selectable, apart from false alarms, only the selected target(s) can trigger alarms. | Sensitivity allows you to calibrate how easily movement could trigger the alarm. A higher value results in the more readily triggers motion detection. |
| Video Tampering Detection | Video tampering detection triggered an alarm when the camera lens is covered and takes | Use the tool bar at the top of image to draw the detection area. | |

| Event Name | Event Description | Rule Configuration | |
|-------------------------------|---|--------------------|--|
| | alarm response action(s). | | |
| Video Loss Detection | Video loss detection detects video loss of a channel and takes alarm response action(s). | - | |
| Audio Exception Detection | Audio exception detection detects abnormal sounds in the scene, such as a sudden increase/decrease in sound intensity. | - | |
| Defocus Detection | Image blur caused by lens defocus can be detected. | - | |
| Sudden Scene Change Detection | Scene change detection detects the change of the video security environment affected by external factors, such as the intentional rotation of the camera. | - | |

6. Click **Arming Schedule** to select an arming schedule type.

 **Note**

If you set **Arming Schedule** as **Custom**, you can drag the cursor on time bar to set customized arming schedule or move the cursor on time bar and click 00:00-24:00  to set specified time schedule.

7. Click **Linkage Method** to set linkage methods.

Table 13-2 Linkage Method Description

| Linkage Method | Description |
|----------------------------|---|
| Notify Surveillance Center | The device can send an exception or alarm signal to the remote alarm host when an event occurs. The alarm host refers to the PC installed with client software (e.g., NVMS V3, XVMS). |

| Linkage Method | Description |
|---------------------|---|
| Alarm Pop-Up Window | When an alarm is triggered, the local monitor displays the alarm pop-up window. |
| Buzzer | When an alarm is detected, the buzzer will make an audible beep. |
| Send Email | The system can send an email with alarm information to a user or users when an alarm is detected. |
| Alarm Output | The alarm output can be triggered by alarm input, motion detection, video tampering detection, face detection, line crossing detection, and any all-other events. |
| Record | <p>When an alarm is detected, the selected channel will record videos.</p> <hr/> <p> Note</p> <p>Video recording schedule shall be enabled for the channel, otherwise this linkage would be invalid. You can go to Desktop → Storage Management → Storage Schedule → Video Recording to configure video recording schedule.</p> <hr/> |

8. Click **Save**.

13.1.2 Perimeter Protection

Perimeter protection events include line crossing detection, intrusion detection, region entrance detection, and region exiting detection.

Configure Line Crossing Detection

Line crossing detection detects people, vehicles, and objects crossing a set virtual line. The detection direction can be set as bidirectional, from left to right or from right to left.

Steps

 **Note**

A part of the following steps is only available for certain NVR or camera models.

1. Go to **Event Center** →  → **Event Configuration** → **Perimeter Protection**.
2. Select a camera and stream type.
3. Select **Line Crossing**.

4. Turn on **Enable**.

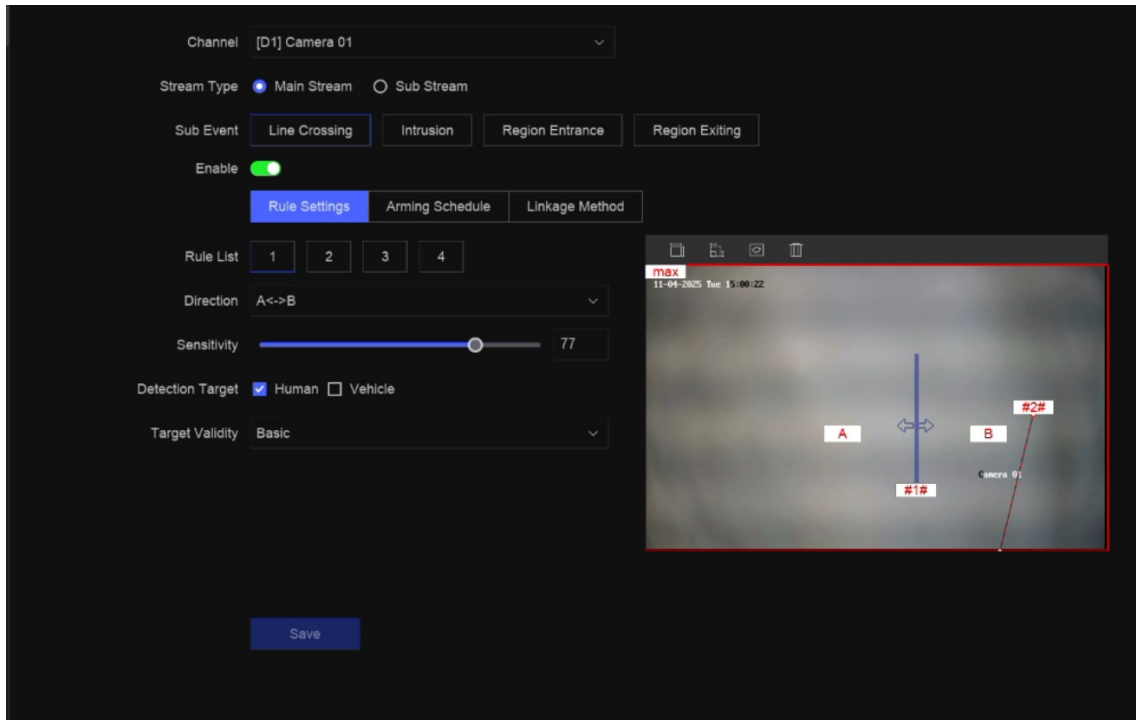



Figure 13-1 Line Crossing Detection

5. Click **Rule Settings** to detection rules.

- 1) Select a rule number. For example, select **1**.
- 2) Click , and click on the image twice respectively to draw the start point and end point of the detection line.
- 3) Set **Direction**, **Sensitivity**, **Detection Target**, and **Target Validity**.

A<->B

Only the arrow on the B side shows. When an object goes across the configured line with both directions can be detected and alarms are triggered.

A->B

Only the object crossing the configured line from the A side to the B side can be detected.

B->A

Only the object crossing the configured line from the B side to the A side can be detected.

Sensitivity

The higher the value is, the more easily the detection alarm can be triggered.

Detection Target

Select **Detection Target** as **Human** or **Vehicle** to discard alarms which are not triggered by human or vehicle. **Detection Target** is only available for certain models.

Target Validity

It is used to indicate the level of certainty or reliability in detecting line crossing events. Setting higher validity levels ensures that only highly reliable detections trigger events, reducing false alarms.

- 4) Optional: Click  to draw **Max. Size** or **Min. Size**. Only targets that meet the size requirement can trigger alarms.
- 5) Optional: Repeat above steps to draw more rules. Up to 4 rules are supported.
6. Click **Arming Schedule** to select an arming schedule type.

 **Note**

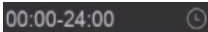
If you set **Arming Schedule** as **Custom**, you can drag the cursor on time bar to set customized arming schedule or move the cursor on time bar and click  to set specified time schedule.

7. Click **Linkage Method** to set linkage methods.

Table 13-3 Linkage Method Description

| Linkage Method | Description |
|----------------------------|---|
| Notify Surveillance Center | The device can send an exception or alarm signal to the remote alarm host when an event occurs. The alarm host refers to the PC installed with client software (e.g., NVMS V3, XVMS). |
| Alarm Pop-Up Window | When an alarm is triggered, the local monitor displays the alarm pop-up window. |
| Buzzer | When an alarm is detected, the buzzer will make an audible beep. |
| Send Email | The system can send an email with alarm information to a user or users when an alarm is detected. |
| Alarm Output | The alarm output can be triggered by alarm input, motion detection, video tampering detection, face detection, line crossing detection, and any all-other events. |
| Record | <p>When an alarm is detected, the selected channel will record videos.</p> <hr/> <p> Note</p> <p>Video recording schedule shall be enabled for the channel, otherwise this linkage would be invalid. You can go to Desktop → Storage Management → Storage Schedule → Video Recording to configure video recording schedule.</p> <hr/> |

8. Click **Save**.

What to do next

You can go to **Live View** and click **Target** to view real-time alarms.

Configure Intrusion Detection

Intrusion detection function detects people, vehicles or other objects that enter and loiter in a pre-defined virtual region. Specific actions can be taken when an alarm is triggered.

Steps



A part of the following steps is only available for certain NVR or camera models.

1. Go to **Event Center** → → **Event Configuration** → **Perimeter Protection**.
2. Select a camera and stream type.
3. Select **Intrusion**.
4. Turn on **Enable**.

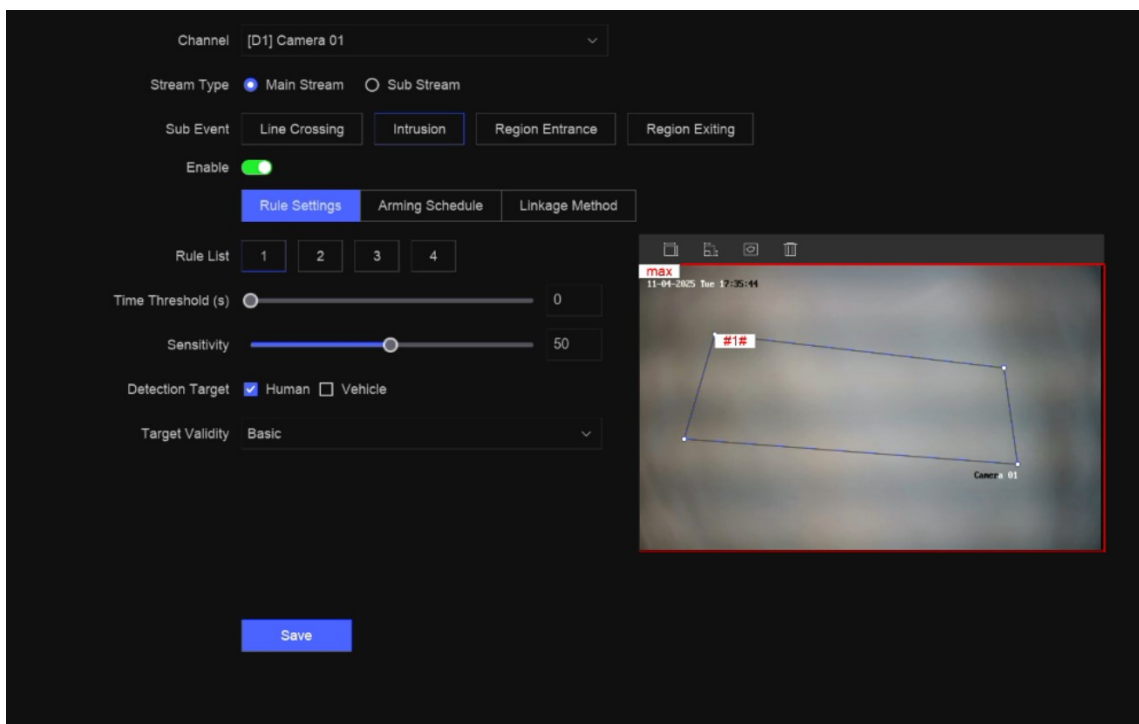

Figure 13-2 Intrusion Detection

5. Click **Rule Settings** to detection rules.
 - 1) Select a rule number. For example, select **1**.
 - 2) Click , and click on the image 4 times respectively to draw each point of a quadrilateral or decagonal area.

3) Set **Time Threshold**, **Sensitivity**, **Detection Target**, and **Target Validity**.

Time Threshold

The time an object loiter in the region. When the duration of the object in the defined detection area exceeds the threshold, the device will trigger an alarm.

Sensitivity



The higher the value is, the more easily the detection alarm can be triggered.

Detection Target

Select **Detection Target** as **Human** or **Vehicle** to discard alarms which are not triggered by human or vehicle. **Detection Target** is only available for certain models.

Target validity

It is used to indicate the level of certainty or reliability in detecting intrusion events. Setting higher validity levels ensures that only highly reliable detections trigger events, reducing false alarms.

4) Optional: Click   to draw **Max. Size** or **Min. Size**. Only targets that meet the size requirement can trigger alarms.

5) Optional: Repeat above steps to draw more rules. Up to 4 rules are supports.

6. Click **Arming Schedule** to select an arming schedule type.

 **Note**

If you set **Arming Schedule** as **Custom**, you can drag the cursor on time bar to set customized arming schedule or move the cursor on time bar and click  to set specified time schedule.

7. Click **Linkage Method** to set linkage methods.

Table 13-4 Linkage Method Description

| Linkage Method | Description |
|----------------------------|---|
| Notify Surveillance Center | The device can send an exception or alarm signal to the remote alarm host when an event occurs. The alarm host refers to the PC installed with client software (e.g., NVMS V3, XVMS). |
| Alarm Pop-Up Window | When an alarm is triggered, the local monitor displays the alarm pop-up window. |
| Buzzer | When an alarm is detected, the buzzer will make an audible beep. |
| Send Email | The system can send an email with alarm information to a user or users when an alarm is detected. |
| Alarm Output | The alarm output can be triggered by alarm input, motion detection, video tampering detection, face detection, line crossing |

| Linkage Method | Description |
|----------------|---|
| | detection, and any all-other events. |
| Record | <p>When an alarm is detected, the selected channel will record videos.</p> <hr/> <p> Note</p> <p>Video recording schedule shall be enabled for the channel, otherwise this linkage would be invalid. You can go to Desktop → Storage Management → Storage Schedule → Video Recording to configure video recording schedule.</p> <hr/> |

8. Click **Save**.

What to do next

You can go to **Live View** and click **Target** to view real-time alarms.

Configure Region Entrance Detection

Region entrance detection detects objects that enter a predefined virtual region.

Steps

 **Note**

A part of the following steps is only available for certain NVR or camera models.

1. Go to **Event Center** →  → **Event Configuration** → **Perimeter Protection**.
2. Select a camera and stream type.
3. Select **Region Entrance**.
4. Turn on **Enable**.

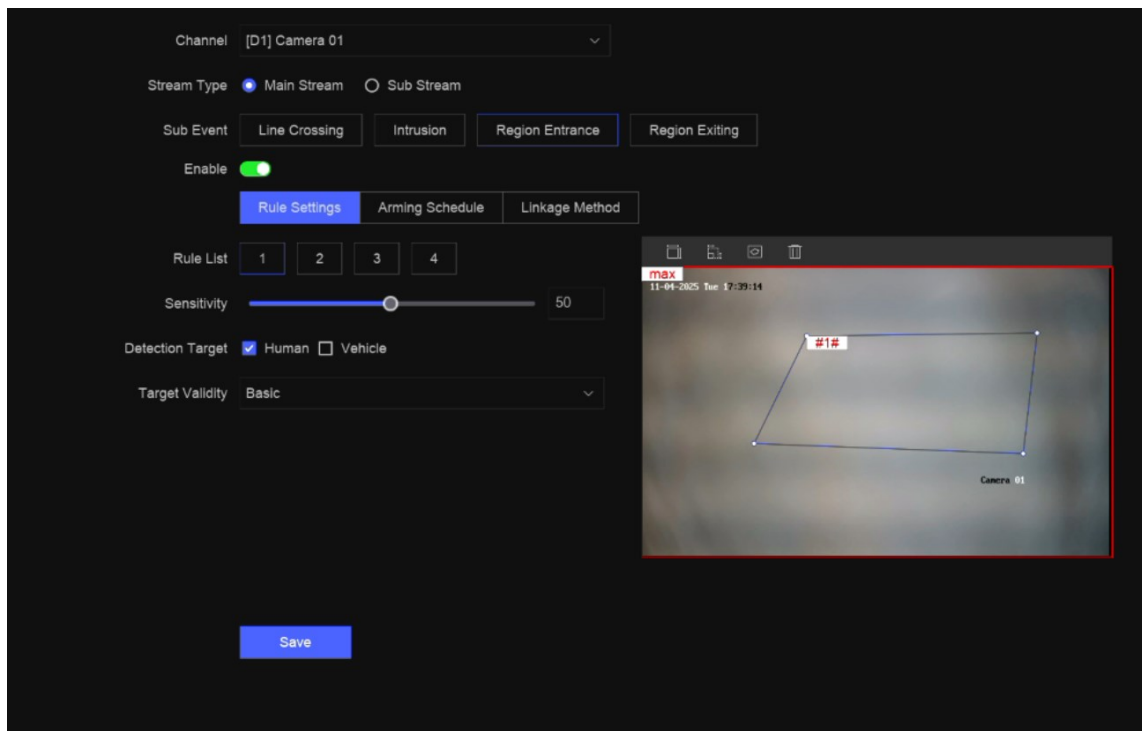



Figure 13-3 Region Entrance Detection

5. Click **Rule Settings** to detection rules.

- 1) Select a rule number. For example, select **1**.
- 2) Click , and click on the image 4 times respectively to draw each point of a quadrilateral or decagonal area.
- 3) Set **Sensitivity**, **Detection Target**, and **Target Validity**.

Sensitivity

The higher the value is, the more easily the detection alarm can be triggered.

Detection Target

Select **Detection Target** as **Human** or **Vehicle** to discard alarms which are not triggered by human or vehicle. **Detection Target** is only available for certain models.

Target Validity

It is used to indicate the level of certainty or reliability in detecting region entrance events. Setting higher validity levels ensures that only highly reliable detections trigger events, reducing false alarms.

- 4) Optional: Repeat above steps to draw more rules. Up to 4 rules are supports.

6. Click **Arming Schedule** to select an arming schedule type.

 **Note**

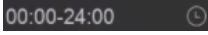
If you set **Arming Schedule** as **Custom**, you can drag the cursor on time bar to set customized arming schedule or move the cursor on time bar and click  to set specified time schedule.

7. Click **Linkage Method** to set linkage methods.

Table 13-5 Linkage Method Description

| Linkage Method | Description |
|----------------------------|---|
| Notify Surveillance Center | The device can send an exception or alarm signal to the remote alarm host when an event occurs. The alarm host refers to the PC installed with client software (e.g., NVMS V3, XVMS). |
| Alarm Pop-Up Window | When an alarm is triggered, the local monitor displays the alarm pop-up window. |
| Buzzer | When an alarm is detected, the buzzer will make an audible beep. |
| Send Email | The system can send an email with alarm information to a user or users when an alarm is detected. |
| Alarm Output | The alarm output can be triggered by alarm input, motion detection, video tampering detection, face detection, line crossing detection, and any all-other events. |
| Record | <p>When an alarm is detected, the selected channel will record videos.</p> <hr/> <p> Note</p> <p>Video recording schedule shall be enabled for the channel, otherwise this linkage would be invalid. You can go to Desktop → Storage Management → Storage Schedule → Video Recording to configure video recording schedule.</p> <hr/> |

8. Click **Save**.

What to do next

You can go to **Live View** and click **Target** to view real-time alarms.

Configure Region Exiting Detection

Region exiting detection detects objects that exit from a predefined virtual region.

Steps

Note

A part of the following steps is only available for certain NVR or camera models.

1. Go to **Event Center** →  → **Event Configuration** → **Perimeter Protection**.
2. Select a camera and stream type.
3. Select **Region Exiting**.
4. Turn on **Enable**.

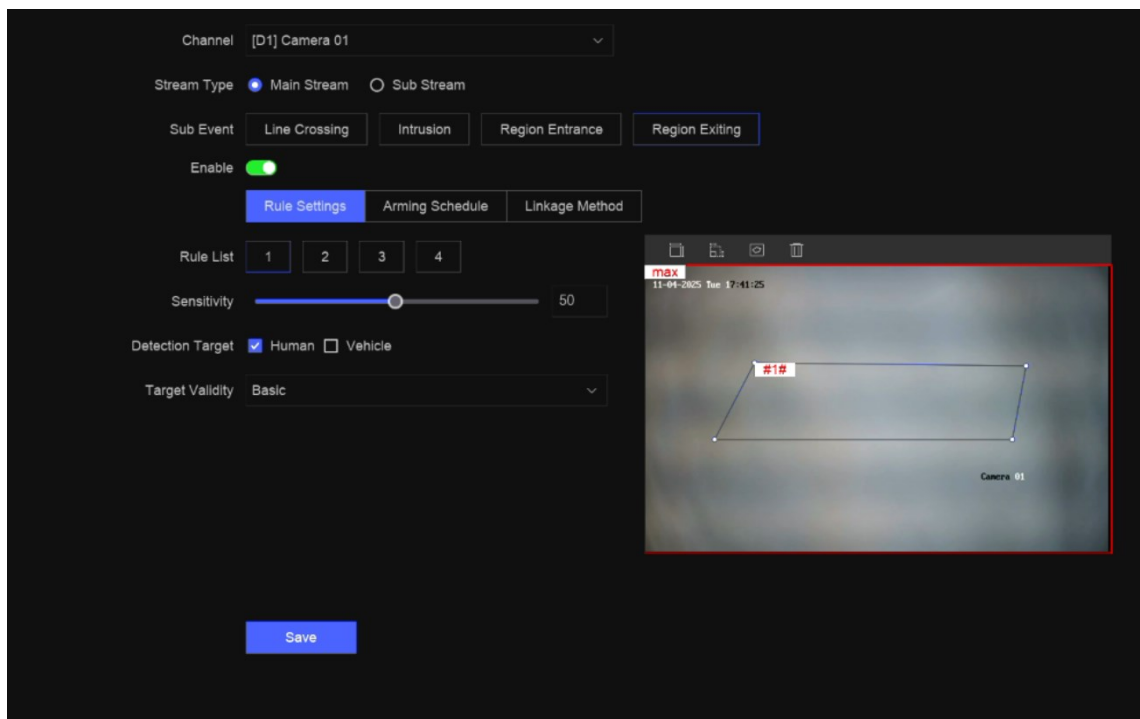



Figure 13-4 Region Exiting Detection

5. Click **Rule Settings** to detection rules.
 - 1) Select a rule number. For example, select **1**.
 - 2) Click , and click on the image 4 times respectively to draw each point of a quadrilateral or decagonal area.
 - 3) Set **Sensitivity**, **Detection Target**, and **Target Validity**.

Sensitivity

The higher the value is, the more easily the detection alarm can be triggered.

Detection Target

Select **Detection Target** as **Human** or **Vehicle** to discard alarms which are not triggered by human or vehicle. **Detection Target** is only available for certain models.

Target Validity

It is used to indicate the level of certainty or reliability in detecting region exiting events. Setting higher validity levels ensures that only highly reliable detections trigger events, reducing false alarms.

- 4) Optional: Repeat above steps to draw more rules. Up to 4 rules are supports.
- 6. Click **Arming Schedule** to select an arming schedule type.

 **Note**

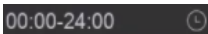
If you set **Arming Schedule** as **Custom**, you can drag the cursor on time bar to set customized arming schedule or move the cursor on time bar and click  to set specified time schedule.

- 7. Click **Linkage Method** to set linkage methods.

Table 13-6 Linkage Method Description

| Linkage Method | Description |
|----------------------------|---|
| Notify Surveillance Center | The device can send an exception or alarm signal to the remote alarm host when an event occurs. The alarm host refers to the PC installed with client software (e.g., NVMS V3, XVMS). |
| Alarm Pop-Up Window | When an alarm is triggered, the local monitor displays the alarm pop-up window. |
| Buzzer | When an alarm is detected, the buzzer will make an audible beep. |
| Send Email | The system can send an email with alarm information to a user or users when an alarm is detected. |
| Alarm Output | The alarm output can be triggered by alarm input, motion detection, video tampering detection, face detection, line crossing detection, and any all-other events. |
| Record | <p>When an alarm is detected, the selected channel will record videos.</p> <hr/> <p> Note</p> <p>Video recording schedule shall be enabled for the channel, otherwise this linkage would be invalid. You can go to Desktop → Storage Management → Storage Schedule → Video Recording to configure video recording schedule.</p> <hr/> |

8. Click **Save**.

What to do next

You can go to **Live View** and click **Target** to view real-time alarms.

13.1.3 Abnormal Behavior Event

Before You Start

Ensure the camera supports this function.

Steps

1. Go to **Event Center** →  → **Event Configuration** → **Abnormal Behavior Event**.
2. Select a camera
3. Select an event type.
4. Turn on **Enable**.
5. Click **Rule Settings** to set the rule.

Table 13-7 Abnormal Behavior Events

| Event Name | Event Description | Rule Configuration |
|---------------------|---|---|
| Loitering Detection | Loitering detection is used to detect whether a target stays within a specified area longer than the set time and trigger alarm for linked actions. | <ol style="list-style-type: none"> 1. Select a rule number. 2. Use the tool bar at the top of image to draw the detection line. 3. Set Time Threshold and Sensitivity. |

Time Threshold

The time of the target staying in the region. If the value is 10, an alarm is triggered after the target has stayed in the region for 10 s. Range: [1-10].

Sensitivity

Similarity of the background image to the object. The higher the value is, more easily the detection alarm will be triggered.

| | | |
|--|----------------------|--|
| 4. Optional: Repeat the above steps to set another one. | | |
| Parking Detection | Parking detection is | |

| | | |
|------------------------------|---|--|
| | used to detect parking violation in the area, applicable in expressway and one-way street. | |
| Unattended Baggage Detection | Unattended baggage detection detects the objects left over in a predefined region such as the baggage, purses, dangerous materials, etc., and a series of actions can be taken when the alarm is triggered. | |
| Object Removal Detection | The object removal detection function detects the objects removed from a predefined region, such as the exhibits on display, and a series of actions can be taken when the alarm is triggered. | |

| | | |
|-----------------------------------|---|--|
| <p>Fast Moving Detection</p> | <p>Fast moving detection is used to detect suspicious running and chasing, over-speed, and fast moving. It will trigger alarm when an object is moving fast and send notification to arming host so that necessary actions can be taken in advance.</p> | |
| <p>People Gathering Detection</p> | <p>People gathering detection is used to detect whether the density of human bodies within a specified area exceeds the set value and trigger alarm for linked actions.</p> | <ol style="list-style-type: none"> 1. Select a rule number. 2. Use the tool bar at the top of image to draw the detection line. 3. Set Percentage. Percentage is the density of human bodies within the area. If it exceeds the threshold value, the device will trigger alarm. 4. Optional: Repeat the above steps to set another one. |

6. Click **Arming Schedule** to select an arming schedule type.

 **Note**

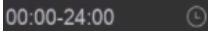
If you set **Arming Schedule** as **Custom**, you can drag the cursor on time bar to set customized arming schedule or move the cursor on time bar and click  to set specified time schedule.

7. Click **Linkage Method** to set linkage methods.

Table 13-8 Linkage Method Description

| Linkage Method | Description |
|---------------------|--|
| Notify Surveillance | The device can send an exception or alarm signal to the remote |

| Linkage Method | Description |
|---------------------|---|
| Center | alarm host when an event occurs. The alarm host refers to the PC installed with client software (e.g., NVMS V3, XVMS). |
| Alarm Pop-Up Window | When an alarm is triggered, the local monitor displays the alarm pop-up window. |
| Buzzer | When an alarm is detected, the buzzer will make an audible beep. |
| Send Email | The system can send an email with alarm information to a user or users when an alarm is detected. |
| Alarm Output | The alarm output can be triggered by alarm input, motion detection, video tampering detection, face detection, line crossing detection, and any all-other events. |
| Record | <p>When an alarm is detected, the selected channel will record videos.</p> <hr/> <p> Note</p> <p>Video recording schedule shall be enabled for the channel, otherwise this linkage would be invalid. You can go to Desktop → Storage Management → Storage Schedule → Video Recording to configure video recording schedule.</p> <hr/> |

8. Click **Save**.

13.1.4 Target Event

Before You Start

Ensure the connected camera supports this function, or the device engine has enabled **Target Recognition** or **Video Structuralization** algorithm in **Desktop** → **Event Configuration** → **Smart Settings** → **Algorithm Management**.

Steps

1. Go to **Event Center** →  → **Event Configuration** → **Target Event**.
2. Select a camera.
3. Select an event.
4. Turn on **Enable**.
5. Set event rules.

| Event Name | Event Description | Rule Configuration |
|-----------------------------|---|---|
| Face Capture | The face capture detects and captures faces appearing in the scene. Linkage actions can be triggered when a human face is detected. | - |
| Face Picture Comparison | The function compares detected face pictures with specified list library. Trigger alarm when comparison succeeded. | <ul style="list-style-type: none"> ● Supports configuring target grading. Face picture comparison begins when the grade of target meets the comparison requirements (the pupil distance is bigger than the configured threshold, and the tilt angle and pan angle are smaller than the configured thresholds). ● Supports configuring prompts for failed and succeeded comparisons. |
| Stranger Detection | Faces not in the list library appearing in the video will be identified as strangers. | <ul style="list-style-type: none"> ● Supports configuring target grading. Face picture comparison begins when the grade of target meets the comparison requirements (the pupil distance is bigger than the configured threshold, and the tilt angle and pan angle are smaller than the configured thresholds). ● Supports configuring the prompt for detecting strangers. |
| Multi-Target-Type Detection | Multi-target-type detection enables the device to detect the faces, human bodies and vehicles simultaneously in a scene. | - |

6. Click **Arming Schedule** to select an arming schedule type.

 **Note**

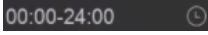
If you set **Arming Schedule** as **Custom**, you can drag the cursor on time bar to set customized arming schedule or move the cursor on time bar and click  to set specified time schedule.

7. Click **Linkage Method** to set linkage methods.

Table 13-9 Linkage Method Description

| Linkage Method | Description |
|----------------------------|---|
| Notify Surveillance Center | The device can send an exception or alarm signal to the remote alarm host when an event occurs. The alarm host refers to the PC installed with client software (e.g., NVMS V3, XVMS). |
| Alarm Pop-Up Window | When an alarm is triggered, the local monitor displays the alarm pop-up window. |
| Buzzer | When an alarm is detected, the buzzer will make an audible beep. |
| Send Email | The system can send an email with alarm information to a user or users when an alarm is detected. |
| Alarm Output | The alarm output can be triggered by alarm input, motion detection, video tampering detection, face detection, line crossing detection, and any all-other events. |
| Record | <p>When an alarm is detected, the selected channel will record videos.</p> <hr/> <p> Note</p> <p>Video recording schedule shall be enabled for the channel, otherwise this linkage would be invalid. You can go to Desktop → Storage Management → Storage Schedule → Video Recording to configure video recording schedule.</p> <hr/> |

8. Click **Save**.

13.1.5 Thermal Camera Detection

The NVR supports the event detection modes of thermal network cameras: fire and smoke

detection, temperature detection, temperature difference detection, etc.

Before You Start

Add the thermal network camera to your device and make sure the camera is activated.

Steps

1. Go to **Event Center** →  → **Event Configuration** → **Thermal Event**.
2. Select a camera.
3. Select an event type.
4. Turn on **Enable**.
5. Click **Rule Settings** to set the rule.

Table 13-10 Thermal Events

| Event Name | Event Description |
|-----------------------|--|
| Fire Detection | An alarm would be triggered when fire is detected in the arming area. |
| Temperature Detection | An alarm would be triggered when the temperature exceeds the threshold value. |
| Perimeter Protection | Perimeter protection events include line crossing detection, intrusion detection, region entrance detection, and region exiting detection. |

6. Click **Arming Schedule** to select an arming schedule type.

 **Note**

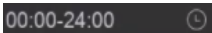
If you set **Arming Schedule** as **Custom**, you can drag the cursor on time bar to set customized arming schedule or move the cursor on time bar and click  to set specified time schedule.

7. Click **Linkage Method** to set linkage methods.

Table 13-11 Linkage Method Description

| Linkage Method | Description |
|----------------------------|---|
| Notify Surveillance Center | The device can send an exception or alarm signal to the remote alarm host when an event occurs. The alarm host refers to the PC installed with client software (e.g., NVMS V3, XVMS). |
| Alarm Pop-Up Window | When an alarm is triggered, the local monitor displays the alarm pop-up window. |
| Buzzer | When an alarm is detected, the buzzer will make an audible beep. |

| Linkage Method | Description |
|----------------|---|
| Send Email | The system can send an email with alarm information to a user or users when an alarm is detected. |
| Alarm Output | The alarm output can be triggered by alarm input, motion detection, video tampering detection, face detection, line crossing detection, and any all-other events. |
| Record | <p>When an alarm is detected, the selected channel will record videos.</p> <hr/> <p> Note</p> <p>Video recording schedule shall be enabled for the channel, otherwise this linkage would be invalid. You can go to Desktop → Storage Management → Storage Schedule → Video Recording to configure video recording schedule.</p> <hr/> |

8. Click **Save**.

13.1.6 Alarm Input Event

Set the handling action of an external sensor alarm.

Steps

1. Go to **Event Center** →  → **Event Configuration** → **Alarm Input Event**.
2. Select an alarm input name.

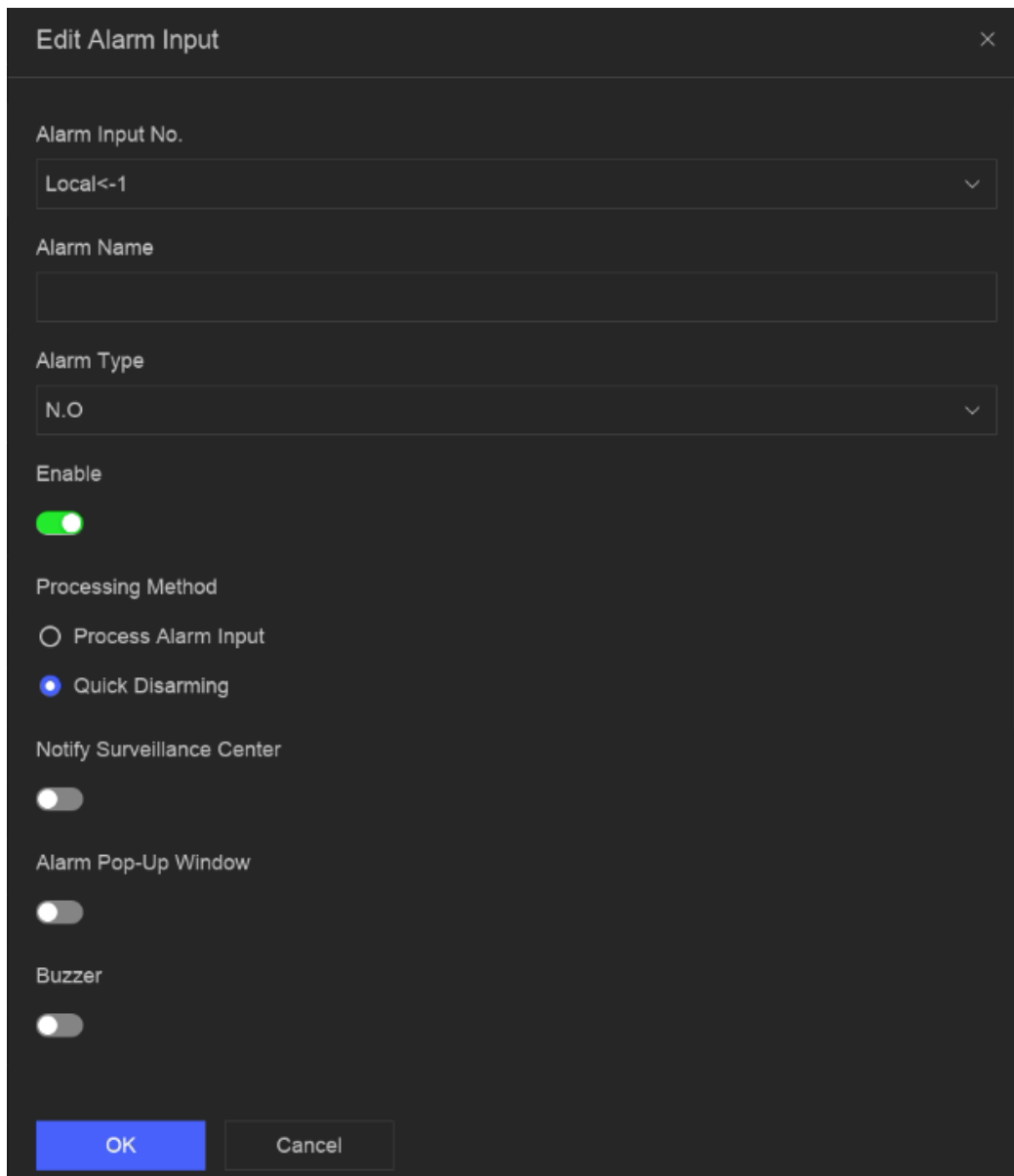

Figure 13-5 Configure Alarm Input

 **Note**

For example, **Local<-1** represents the alarm input number at the device rear panel is 1.

3. Edit **Alarm Name**.
4. Set **Alarm Type**.

N.O

When contacts are in natural and off-power state, if two contacts are off, then they can be called normal open.

N.C

When contacts are in natural and off-power state, if two contacts are conducted, then they can be called normal closed.

5. Turn on **Enable**.
6. Optional: If you select **Local<-1** in Step 2, select the processing method.
 - Select **Process Alarm Input**, and then you can set the corresponding arming schedule, linkage methods, etc.

 **Note**

The operations below are all available when you select this processing method.

- Select **Quick Disarming**, and then linkage methods of all events will be disabled.
7. Click **Configure** to configure combined alarm.
 - 1) Select a channel.
 - 2) Select combined alarm events such as motion detection and video tampering detection.
 - 3) Click **OK**.

The combined alarm will be triggered when it receives alarms from both alarm input and events.
 8. Click **Arming Schedule** to select an arming schedule type.

 **Note**

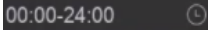
If you set **Arming Schedule** as **Custom**, you can drag the cursor on time bar to set customized arming schedule or move the cursor on time bar and click  to set specified time schedule.

9. Click **Linkage Method** to set linkage methods.

Table 13-12 Linkage Method Description

| Linkage Method | Description |
|----------------------------|---|
| Notify Surveillance Center | The device can send an exception or alarm signal to the remote alarm host when an event occurs. The alarm host refers to the PC installed with client software (e.g., NVMS V3, XVMS). |
| Alarm Pop-Up Window | When an alarm is triggered, the local monitor displays the alarm pop-up window. |
| Buzzer | When an alarm is detected, the buzzer will make an audible beep. |
| Send Email | The system can send an email with alarm information to a user or users when an alarm is detected. |
| Alarm Output | The alarm output can be triggered by alarm input, motion detection, video tampering detection, face detection, line crossing detection, and any all-other events. |

| Linkage Method | Description |
|----------------|---|
| Record | <p>When an alarm is detected, the selected channel will record videos.</p> <hr/> <p> Note</p> <p>Video recording schedule shall be enabled for the channel, otherwise this linkage would be invalid. You can go to Desktop → Storage Management → Storage Schedule → Video Recording to configure video recording schedule.</p> <hr/> |

10. Click **Save**.

13.1.7 Audio Analysis Event

Steps

1. Go to **Event Center** →  → **Event Configuration** → **Audio Analysis**.
2. Select a channel.
3. Select an event type.
4. Turn on **Enable**.
5. Click **Rule Settings** to set the rule.

Table 13-13 Audio Analysis Event

| Event Name | Event Description | Rule Configuration |
|---------------------------|--|--------------------|
| Audio Exception Detection | Audio exception detection detects abnormal sounds in the scene, such as a sudden increase/decrease in sound intensity. | |

| |
|--|
| <p>Sudden Increase of Sound Intensity Detection Detects a steep sound increase in the scene.</p> <p>Sudden Decrease of Sound Intensity Detection Detects a steep sound drop in the scene.</p> <p>Sensitivity The higher the value is, the easier the detection alarm can be triggered.</p> <p>Sound Intensity Threshold</p> |
|--|

It can filter the sound in the environment. The louder the environment sound is, the higher the value should be. Adjust it according to the environment.

6. Click **Arming Schedule** to select an arming schedule type.

 **Note**

If you set **Arming Schedule** as **Custom**, you can drag the cursor on time bar to set customized arming schedule or move the cursor on time bar and click 00:00-24:00  to set specified time schedule.

7. Click **Linkage Method** to set linkage methods.

Table 13-14 Linkage Method Description

| Linkage Method | Description |
|----------------------------|---|
| Notify Surveillance Center | The device can send an exception or alarm signal to the remote alarm host when an event occurs. The alarm host refers to the PC installed with client software (e.g., NVMS V3, XVMS). |
| Alarm Pop-Up Window | When an alarm is triggered, the local monitor displays the alarm pop-up window. |
| Buzzer | When an alarm is detected, the buzzer will make an audible beep. |
| Send Email | The system can send an email with alarm information to a user or users when an alarm is detected. |
| Alarm Output | The alarm output can be triggered by alarm input, motion detection, video tampering detection, face detection, line crossing detection, and any all-other events. |
| Record | <p>When an alarm is detected, the selected channel will record videos.</p> <hr/> <p> Note</p> <p>Video recording schedule shall be enabled for the channel, otherwise this linkage would be invalid. You can go to Desktop → Storage Management → Storage Schedule → Video Recording to configure video recording schedule.</p> <hr/> |

8. Click **Save**.

13.2 Linkage Configuration

Configure parameters for event linkages.

Steps



1. Go to **Event Center** →  → **Event Configuration** → **Linkage Configuration** or **Desktop** → **Event Configuration** →  → **Event Configuration** → **Linkage Configuration**.
2. Click **Email** to configure email parameters.

Table 13-15 Email Linkage

| Item | Description |
|---|--|
| Server Authentication | Enable it if the SMTP server requires user authentication and enter the user name and password accordingly. |
| SMTP Server | The IP address of SMTP Server or host name (e.g., smtp.263xmail.com). |
| SMTP Port | The SMTP port. The default TCP/IP port used for SMTP is 25. |
| Enable SSL/TLS | Enable SSL/TLS if the SMTP server has the requirement. |
| Sender | The sender name. |
| Sender's Address | The sender's address. |
| Select Receivers | Select the receiver. Up to 3 receivers can be configured. |
| Attached Image | Send email with attached alarm images. |
| Enable 3 Attached Images for Perimeter Protection | When a perimeter protection event is triggered, the device would send an email with 3 attached alarm images. |
| Interval | The time interval for capturing the attached images. |

Note

If you are using an Outlook email account, please set **Email Type** as **Outlook**, and click **Help** at the right side to read the configuration instructions, then follow the steps on the interface to complete the configuration.

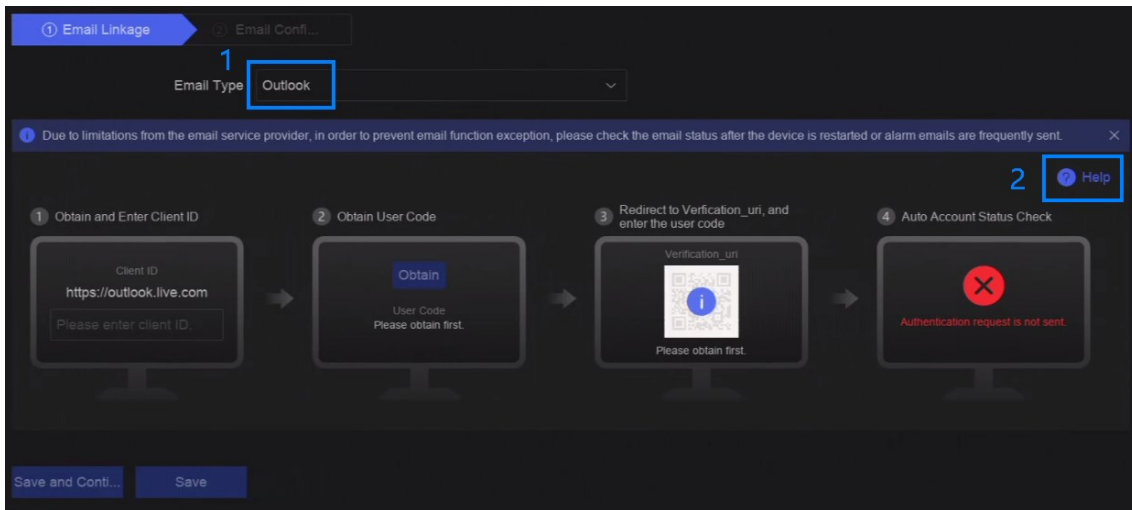

Figure 13-6 Outlook Email Configuration

3. Click **Audio Management** to manage audio files for alarm linkage.

Note

There are 3 default audio files in the list which cannot be deleted. You can import audio files from USB flash drive. The files shall be in AAC, or MP3 format, and each file size should be within 1 MB.

4. If you have connected IP speakers, click **IP Speaker** to import audio files into the selected IP speaker(s) for alarm linkage.

Note

- This linkage action is only available for few event types.
- The uploaded audio file should be in MP3, WAV, or ACC format, and the file size should be less than 1 MB.

5. Click **Alarm Output** to set alarm output parameters.

Note

- Click the name of each alarm output to edit it.
- The alarm output No. is the same as the one at the device rear panel. For example, **Local->1** means the alarm out No. 1 at the device rear panel.

Delay

The alarm signal duration.

Alarm Status

Click **Trigger** to switch the status.

- If you have connected audio and light cameras, click **Camera Audio and Light Configuration** to configure the camera flashing light and camera speaker parameters for alarm linkage.

Note

This linkage action is only available for few event types.

- If you have connected security control panels, click **Security Control Panel** to configure parameters including IP address and port number.

13.3 Disarming Configuration

After a disarming template is configured, you can use the template to disarm channels in a batch. The channels that have enabled **Allow Disarming** would not trigger the alarm linkage items according to the disarming template.

Steps

- Go to **Event Center** →  → **Event Configuration** → **Linkage Configuration** or **Desktop** → **Event Configuration** →  → **Event Configuration** → **Linkage Configuration**.

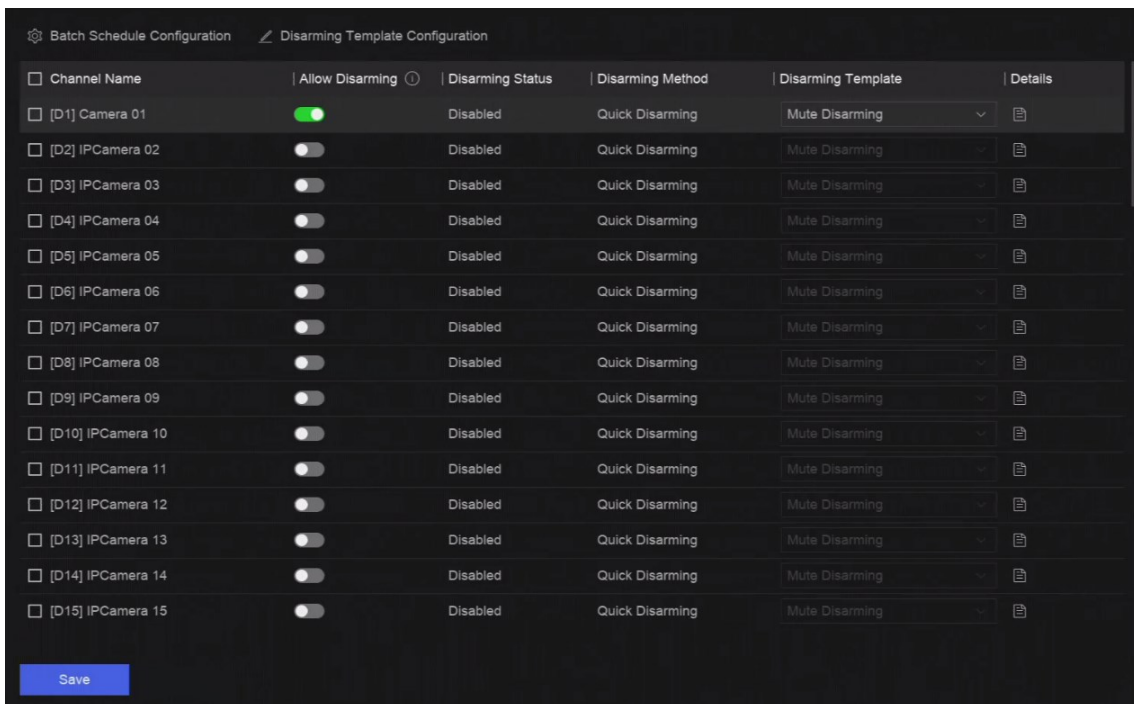

Figure 13-7 Disarming Configuration



- Select channel(s) that are allowed for disarming.
- Click **Batch Schedule Configuration**.
- Turn on **Enable**.
- Select **Disarming Template**. Only two types are available

 **Note**

Currently, only two template types are available and each template parameters cannot configured.

6. Click **OK**.

13.4 Batch Configuration

The listed events and the corresponding linkage action of **Notify Surveillance Center** can be enabled or disabled in batches through **Event Center** →  → **Event Configuration** → **Batch Configuration** or **Desktop** → **Event Configuration** →  → **Event Configuration** → **Batch Configuration**. After an event is enabled, please click **Go to Event Configuration** to set rules.

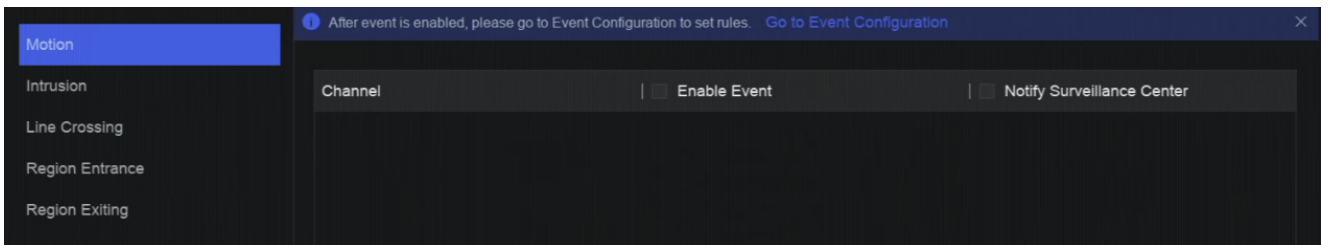

Figure 13-8 Batch Configuration

13.5 Event Search

You can search for event files like videos and pictures according to the searching conditions.

Steps

1. Go to **Event Center** → .

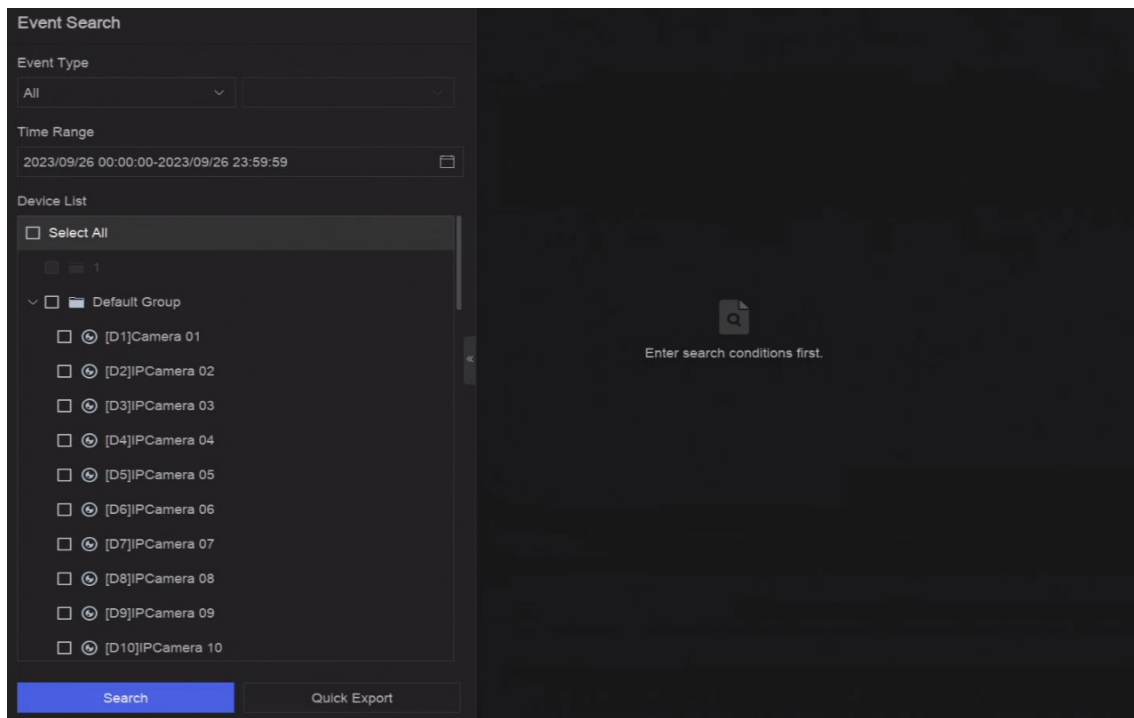

Figure 13-9 Event Search

2. Specify detailed conditions, including event type, time, channel, etc.
3. Click **Search**.

The device will display the searching results of the selected channel(s).

What to do next

Select the items from the result list and export them for backup.

13.6 View Alarms

You can view real-time alarm videos and pictures and play them back.

Steps

1. Go to **Event Center** → .
2. Click **Real-Time Alarm**.
3. Select the alarm from the list.

If there are too many alarms, click **Filter** to search and find the alarm.

4. Click **Playback**, and the alarm recording video would be played back.
5. View the alarm picture(s) on the right side. The number of available pictures would be listed.

Chapter 14 Search and File Management

You can search for files according to different searching conditions, including file type, event type, time, tag, etc. The search results can be exported to another device, such as a USB flash drive.

Before You Start

Ensure HDD is correctly installed and recording parameters are properly configured.

Steps

1. Go to **File Management**.

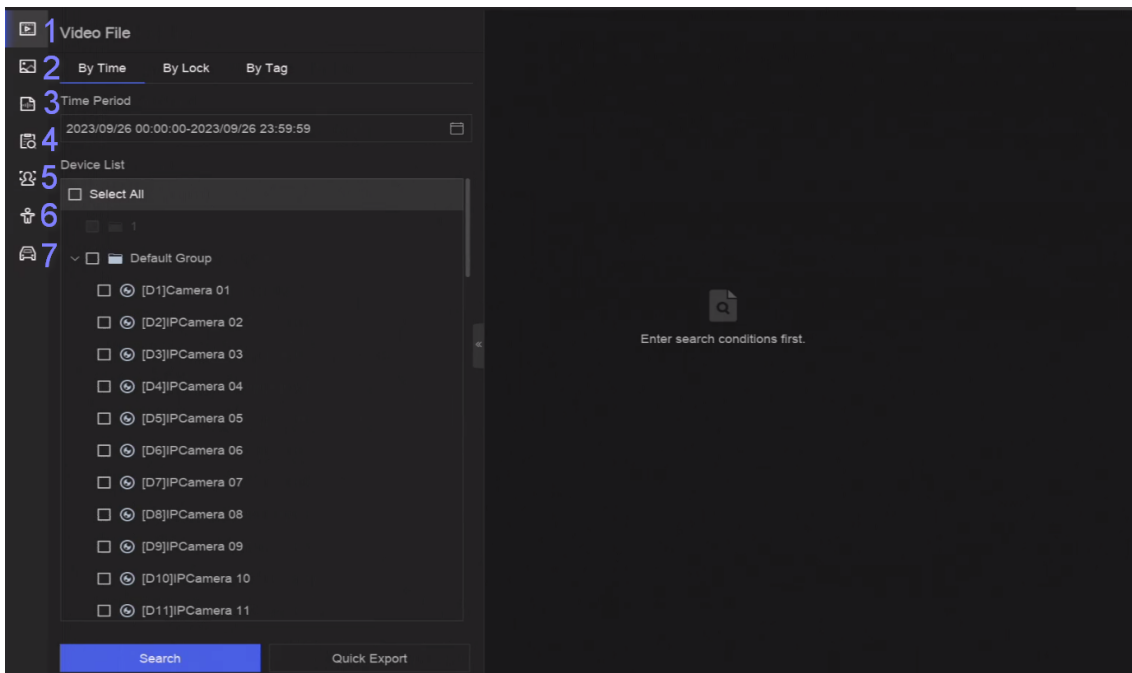

Figure 14-1 Search and File Management

2. Choose a searching method from the left side as your desire, 7 types are supported.

Note

The searching conditions would vary according to the selected searching method.

3. Set the search conditions.
4. Click **Search**.

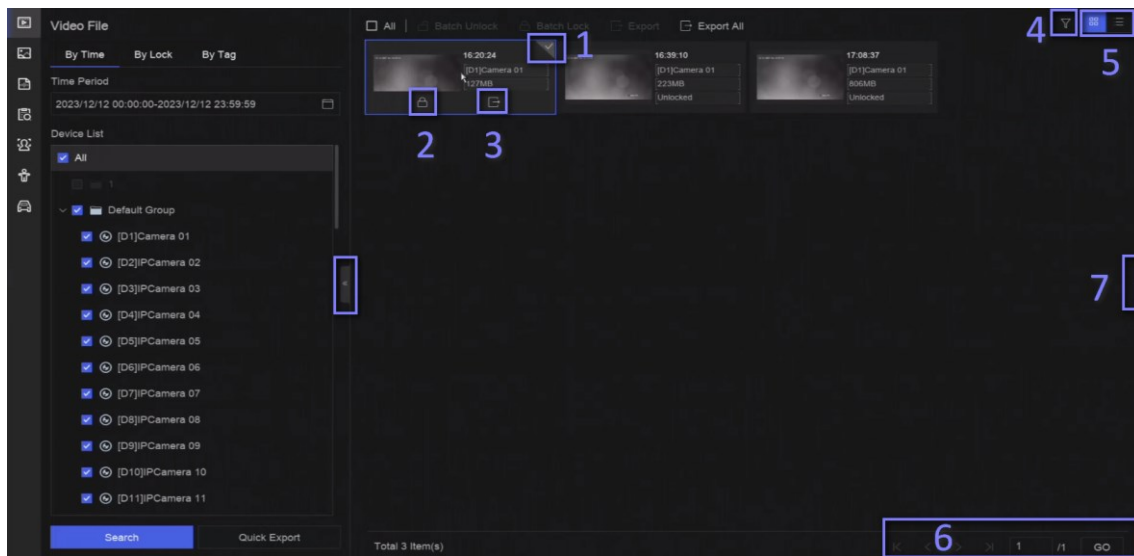

Figure 14-2 Searching Result

5. Optional: Perform the following operations.

- 1 Click to select a file.
- 2 Click to lock a file. After a file is locked, it will not be overwritten.
- 3 Click to export a file.
- 4 Use the tool bar at the top to filter results by channel.
- 5 Use the tool bar at the top to switch display effect.
- 6 Go to different result pages.
- 7 Expand or collapse the interface. After selecting a video from the result list, you will be able to quickly play it back.

6. Insert a USB flash drive to the device for backup.

7. Export files to the USB flash drive.

- Select file(s) in the result list and click **Export**.
- Click **Export All** to export all the files.

Chapter 15 DeepVision

DeepVision enables efficient and accurate retrieval of desired images and video clips by simply entering relevant text descriptions.

Before You Start

- Make sure you have added the camera which supports DeepVision and configured recording schedule for the camera.
- Make sure you have configured Direct Search engine. Refer to [Direct Search](#).

Steps

1. Go to **Event Center** → **Event Configuration** → **Smart Settings** → **Algorithm Management** → **Intelligent Search**, select **DeepVision**, and check target analysis for the corresponding channels.

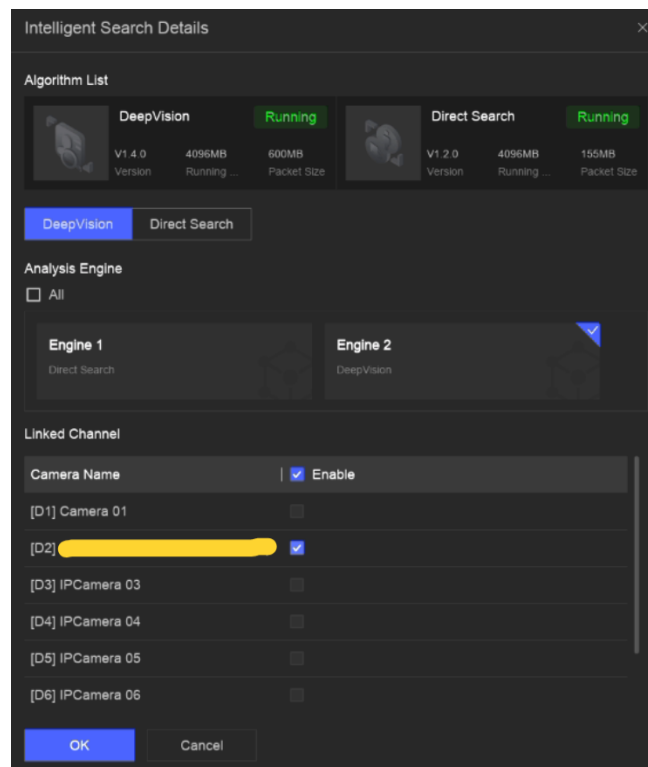

Figure 15-1 Configure DeepVision Engine

2. On the GUI main page, click **DeepVision**, and set conditions according to actual needs.

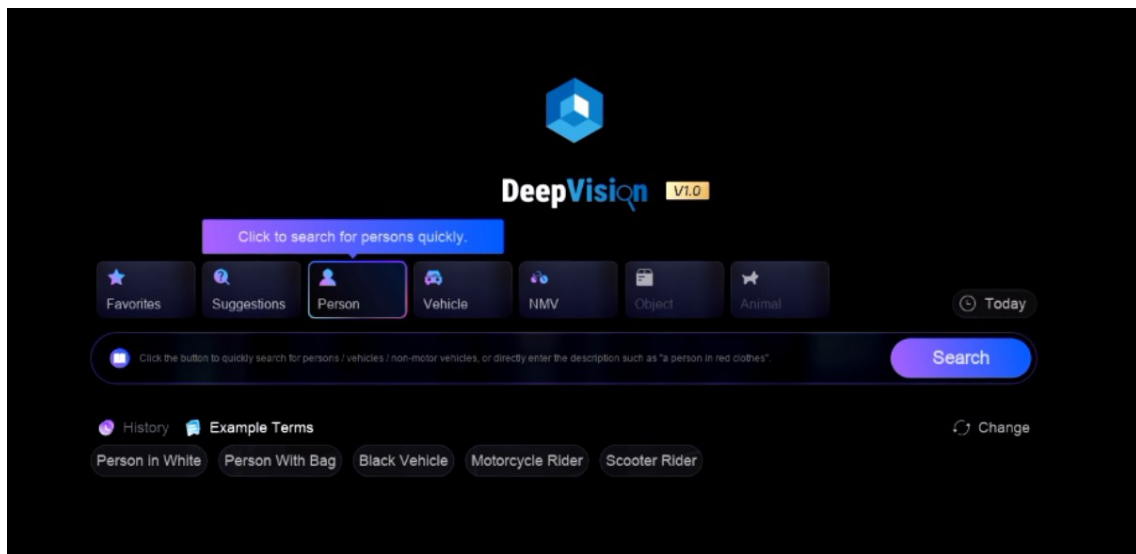



Figure 15-2 Set Search Conditions

- (Recommended) Click **Suggestions**, **Person**, **Vehicle**, or **NMV**, and select from the predefined conditions. When searching for people and vehicles, you can select conditions from multiple aspects. For example, you can search for a person wearing a yellow top, blue bottom and a hat.
 - Enter the condition in the search box.
 - Click **Favorites** to select conditions from Favorites. You can click **Custom** to add terms to Favorites.
 - Click **Today**, and define the time (3 Days, 7 Days, Custom) for searching.
 - Click a history search condition / an example term below the search box. You can click  to add a history search condition to Favorites.
3. Click **Search** to view the searched results, and perform more operations according to the figure below.

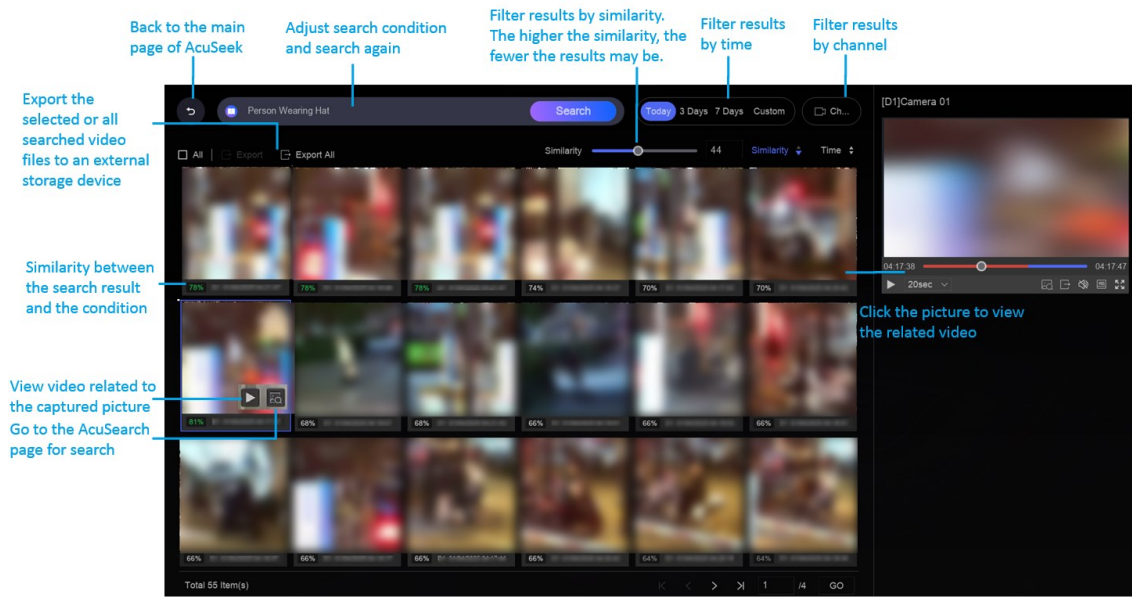

Figure 15-3 DeepVision Results

Chapter 16 Direct Search

Direct Search function firstly extracts pictures of human face or body from a video scene during live view or playback, then compares the extracted picture with recorded videos, and eventually finds out videos that contain the target.



Before You Start

Ensure your device or camera supports this function.

Steps

1. Go to **Desktop** → **Event Configuration** → **Smart Settings** → **Algorithm Management** to enable Direct Search algorithm.
2. Go to Live View or Playback and click  at the lower-right or lower-left corner during video playing.

Note

- If targets are hard to find during playback, it is recommended to use **Smart Search** () to find scenes that contain targets.
- Human face and body would be framed with different colors.
- After clicking , you can also drag the cursor on the image to manually frame a target or manually adjust the frame area.

3. Click  of the selected target.

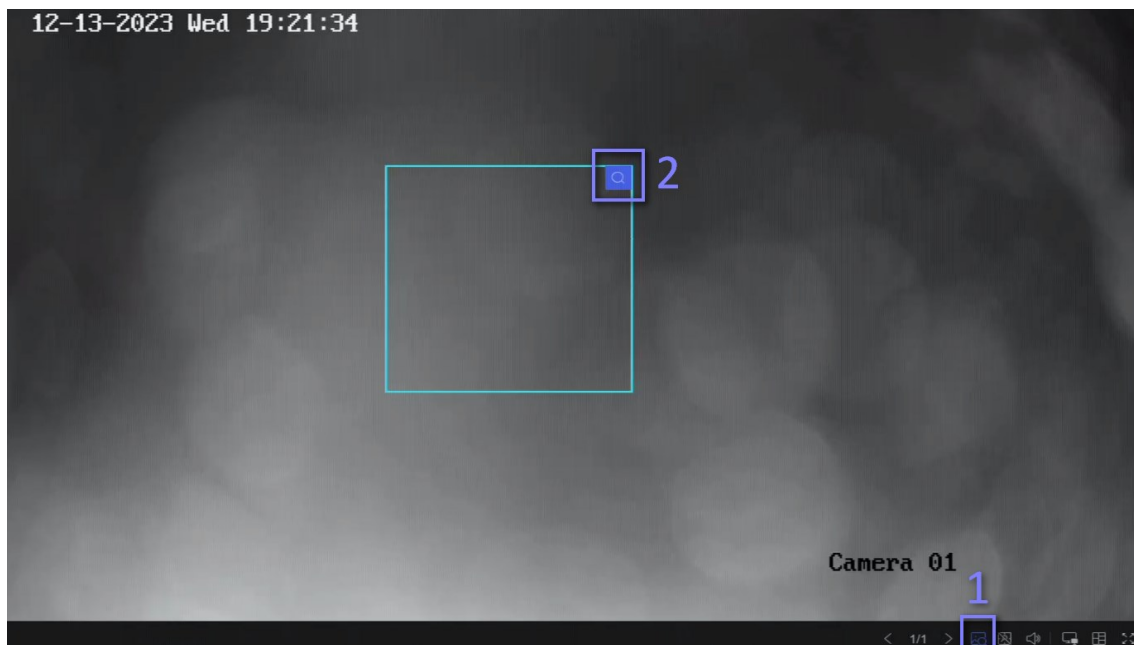

Figure 16-1 Direct Search

If compared videos are found, the device will redirect to Direct Search interface.

4. View searching results.

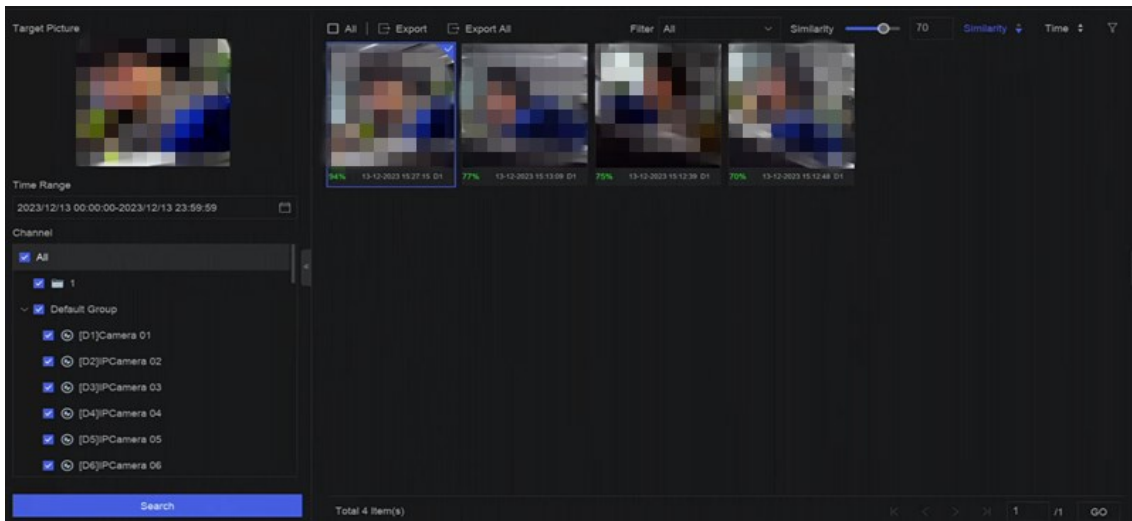

Figure 16-2 Direct Search Result

- Optional: If the results are not desired, you can adjust parameters like **Time Range**, **Channel**, or **Similarity** to search again.
- Optional: Select an item from the result list, and its corresponding video will be played back at the right side and be marked with red color. You can click the icons at the tool bar to perform functions.

Chapter 17 Smart Settings

17.1 Algorithm Management

Algorithms are used for device engines to analyze different smart functions. Smart functions would be usable after allocating the corresponding algorithm to an engine.

Go to **Desktop** → **Event Configuration** → **Smart Settings** → **Algorithm Management** or **Event Center** → **Event Configuration** → **Smart Settings** → **Algorithm Management**. The available algorithms would be listed, and you can click the required algorithm to link engine(s).

For certain models that support Direct Search algorithm, you can choose the camera (**AI by Camera**) to run Direct Search algorithm.

17.2 Engine Status

You can view the engine status, including running status, temperature and algorithm name.

Go to **Desktop** → **Event Configuration** → **Smart Settings** → **Engine Status** or **Event Center** → **Event Configuration** → **Smart Settings** → **Engine Status**. If you need to switch the algorithm, refer to [Algorithm Management](#).

17.3 Task Plan Management

You can view the task status in task configuration. Smart analysis results are used for filtering pictures when searching for interested human body and vehicle pictures.

Go to **Desktop** → **Event Configuration** → **Smart Settings** → **Task Plan Management** or **Event Center** → **Event Configuration** → **Smart Settings** → **Task Plan Management**. For **Non-Real-Time Target Comparison**. For **Non-Real-Time Target Comparison**, you can view the progress of each day.

Task status mainly includes 3 conditions: **Disabled**, **Waiting**, and **Enabled**.

Disabled

No analysis task is enabled on the camera.

Waiting

The analysis task of the camera is enabled. Device is waiting to analyze data.

Enabled

The analysis task of the camera is enabled, and device is analyzing data of the camera.

17.4 List library Management

List library is mainly used for target picture storage and target comparison. **Strangers** library is used to store pictures for strangers, and it cannot be deleted.

17.4.1 Add a List Library

Steps

1. Go to **Desktop** → **Event Configuration** → **Data Archive** → **List Library** or **Event Center** → **Event Configuration** → **Data Archive** → **List Library**.
2. Click **Add**.
3. Enter the library name.
4. Click **Confirm**.

Note

- After a list library, you can move the cursor on the library to edit or delete it.
 - You can click **Delete in Batch** to delete selected libraries or clear all pictures in the selected libraries.
-

17.4.2 Upload Face Pictures to the Library

Target picture comparison is based on target pictures in the library. You can upload a single target picture or import multiple target pictures to the library.

Before You Start

- Ensure the picture format is JPEG or JPG.
- Import all pictures to a backup device in advance.

Steps

1. Double click a list library.
 2. Optional: Click **Custom Tag** to add tags to pictures. The tag can be edited as your desire, for example, personal information, organization, position, etc.
 3. Click **Add** or **Import**.
 4. Import picture(s).
 - **Add**: Click  to upload a picture at a time. If the picture has multiple targets, you have to pick one from them.
 - **Import**: Multiple pictures can be imported at a time. The device will use the file name as its picture name and leave other attributes empty or import picture files by specified rules. If a picture has multiple targets in the image, the device will choose the target at the center by default.
 5. Optional: Perform the following operations.
-

- | | |
|---|---|
| Delete Pictures from the Library | <ul style="list-style-type: none">● Select a picture and delete it.● Select pictures and click Delete in Batch to delete the select ones. |
| Search Pictures in the Library | Click  at the tool bar to search for pictures. |
| Copy Pictures to Another Library | Select pictures and click Copy to to copy the uploaded pictures of the current library to another library. |
| Edit Pictures | Click the picture name and edit its attributes. |
| Export Pictures | Select pictures and click Export to export them to a USB flash drive. |

17.5 Self-Learning Settings

Self-learning technology optimizes algorithm accuracy and requires minimum manual intervention from users. When self-learning function is enabled, the device would automatically collect false alarm materials and use the collected materials to constantly train and optimize the corresponding algorithm.

Go to **System** → **Event Configuration** → **Event Configuration** → **Smart Settings** → **Algorithm Management** or **Event Center** → **Event Configuration** → **Smart Settings** → **Algorithm Management** to enable **Self-Learning** algorithm.

Note

- Only certain models support this function.
 - Currently, self-learning function can only be adopted for perimeter protection events.
-

17.5.1 Self-Learning Task Management

After self-learning algorithm is running, the self-learning task should be enabled as well.

Go to **System** → **Event Configuration** → **Event Configuration** → **Self-Learning** → **Task Management** or **Event Center** → **Event Configuration** → **Self-Learning** → **Task Management** to enable the task.

The available task would be listed, and you can view task status and progress bar. It would take a long time for the material collection.

When the task is completed, self-learning algorithm would be updated automatically. You can click **Auto Update Config** to set **Update Time**.

Note

- When the self-learning algorithm would be unavailable for perimeter protection events when
-

the algorithm is updating.

- **Force Training** is only used for the technical support.
-

17.5.2 Model Management

You can set the self-learning algorithm model version according to your requirement.

Go to **System** → **Event Configuration** → **Event Configuration** → **Self-Learning** → **Model Management** or **Event Center** → **Event Configuration** → **Self-Learning** → **Model Management** to set the model version.

Restore to Previous Version

Restore the model to the version before this one.

Restore to Default Version

Restore the model to the factory default version.

17.5.3 Smart Status

You can view the self-learning algorithm performance status of each channel in **System** → **Event Configuration** → **Event Configuration** → **Self-Learning** → **Smart Status** or **Event Center** → **Event Configuration** → **Self-Learning** → **Smart Status**.

Chapter 18 Application Center

18.1 Person Check-In

After check-in tasks are added, you can view the live check-in information and search check-in results.

18.1.1 Add Check-In Task

Before starting person check-in, the corresponding task should be properly configured.

Before You Start

- A camera for person check-in is properly connected.
- Go to **Desktop** → **Event Configuration** → **Smart Settings** → **Algorithm Management**. Allocate **Target Recognition** to at least one engine.
- The list library for check-in comparison is properly configured. Refer to [Add a List Library](#) for details.

Steps

1. Click **Person Check-In**.
2. Right click to display the menu on the left side.
3. Click .
4. Click **Add**.

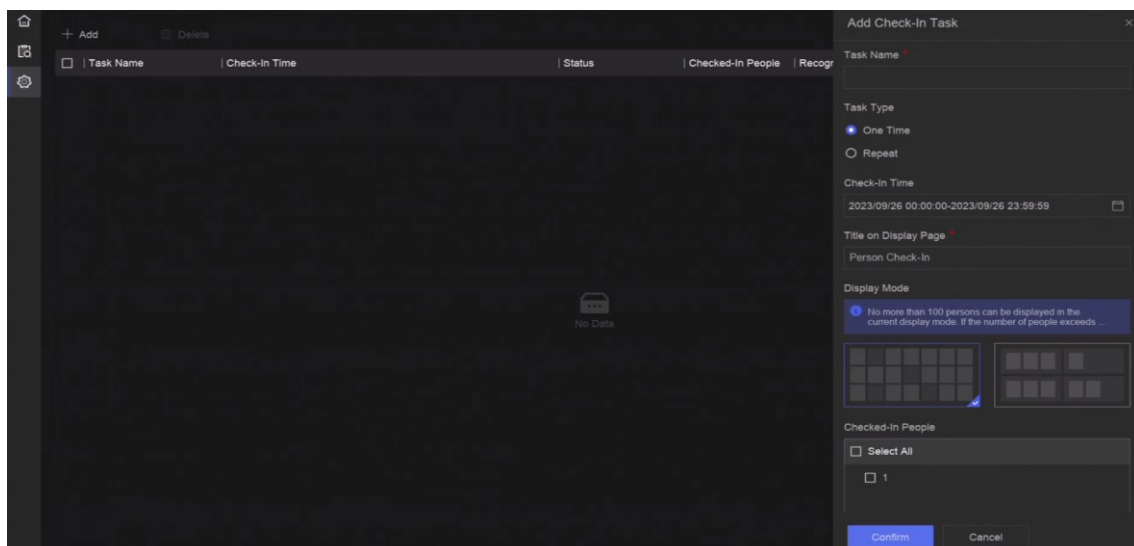

Figure 18-2 Add Check-In Task

5. Set **Task**.

One-Time

The task will be used for one time.

Repeat

The task will be used and repeated several times.

6. Configure other parameters, including **Task Name**, **Check-In Time**, **Recognition Channel**, etc.
7. Click **Confirm**.

18.1.2 Search Check-In Records

After check-in tasks are configured, you can search the records by day or month.

Before You Start

Ensure check-in tasks are configured.

Steps

1. Go to **Person Check-In**.
2. Right click to display the menu at the left side.
3. Click .

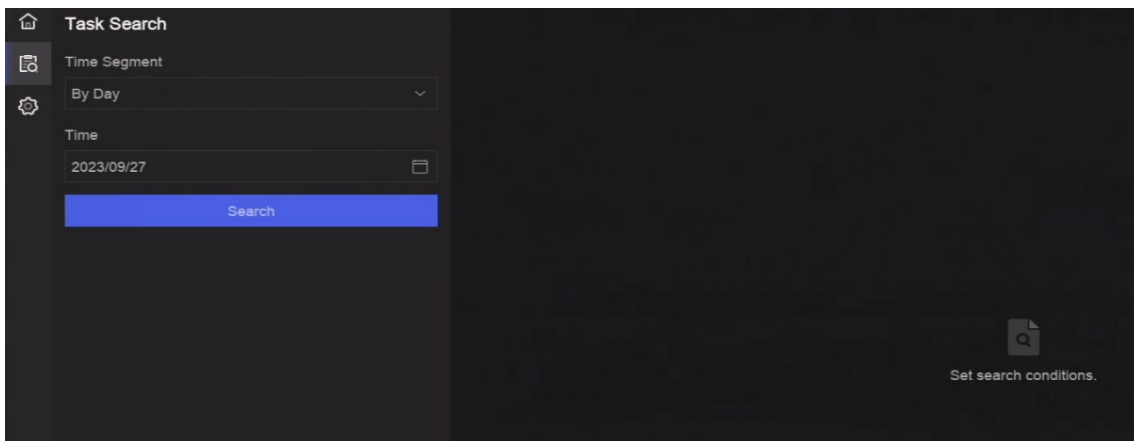



Figure 18-3 Search Check-In Records

4. Set time.
5. Click **Search**.

18.2 Statistic Report

You can view reports of people counting and heat map.

Table 18-2 Statistic Report Introduction

| Function Name | Icon | Condition | Description |
|-----------------|--|---|---|
| People Counting |  | <ul style="list-style-type: none"> The function must be supported by the connected IP camera. For example, a people counting camera is connected to your device. Camera statistic data can be stored to the device HDD. | People counting calculates the number of people entering or leaving a certain configured area and creates daily/weekly/monthly/annual reports for analysis. |
| Heat Map |  | <ul style="list-style-type: none"> The function must be supported by the connected IP camera. Camera statistic data can be stored to the device HDD. | Heat map is a graphical representation of data. The heat map function is used to analyze how many people visited and stayed in a specific area. |

Chapter 19 System Parameter Settings

System parameters include device name, region, time, lock screen time, language, etc. Go to **Desktop** → **System Settings** → **System Configuration** to configure parameters.

Table 19-1 Parameter Description

| Type | Parameter Name | Description |
|-----------------------------|-------------------------------------|---|
| Basic Info | Lock Screen Time | The screen would be locked when the cursor is not moving for the specified time. |
| | Live View Permission on Lock Screen | After the screen is locked, the device would play the live image of cameras that have this permission. |
| Region & Time Configuration | Time Zone Lock | The admin password is required for this operation. After Time Zone is locked, the device time zone information cannot be remotely changed from other platforms or interfaces, such as the web interface via web browser. You can only lock or unlock Time Zone through local GUI interface. |
| | Time Sync Mode | <ul style="list-style-type: none"> ● NTP Time Sync: You can select NTP Time Sync and configure NTP Server, NTP Server Port, NTP Client Port, and Interval. Interval is the time interval between two synchronizing actions within the NTP server. If the device is connected to a public network, you should use a NTP server that has a time synchronization function, such as the listed server addresses for selection. If the device is set in a customized network, NTP software can be used to establish an NTP server for time synchronization. ● Manual Time Sync: Manually set the system time. ● LTS Connect Server Time Sync: The device will sync time with LTS Connect instead of NTP server. ● PT Cloud Server Time Sync: The device will sync time with PT Cloud instead of NTP server. |
| | DST | DST (daylight saving time) refers to the period of the year when clocks are moved one period ahead. In some areas worldwide, this has the effect of creating more sunlit hours in the evening during months when the |

| Type | Parameter Name | Description |
|--------------|----------------------------|--|
| | | <p>weather is warmer.</p> <p>We advance our clocks ahead a certain period (depends on the DST bias you set) at the beginning of DST, and move them back the same period when we return to standard time (ST).</p> |
| Menu Output | Auxiliary Port Auto-Switch | <p>When two or more monitors are connected to rear panel, one of them may become the auxiliary output that cannot enter main menu. Images at the auxiliary output windows will be automatically switched to next ones according to the interval.</p> |
| Channel-Zero | - | <p>Channel-zero, known as virtual channel, can show live images of all channels of the device, which saves bandwidth for transmission.</p> |
| RS-232 | Usage | <p>Console</p> <p>After connecting it to PC with a converter, PC can set the device parameters.</p> <p>Transparent Channel</p> <p>It is directly connected to a serial device. PC can remotely access the serial device through network.</p> |

Chapter 20 Hot Spare Device Backup

Video recorders can form an N+M hot spare system. The system consists of several working video recorders and at least one hot spare video recorder. When a working video recorder fails, the hot spare video recorder would switch into operation, which increases the reliability of the system. A bidirectional connection shown in the figure below is required to be built between hot spare video recorder(s) and working video recorders.

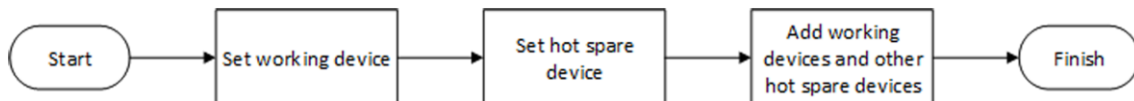

Figure 20-1 Build a Hot Spare System

Note

- Up to 32 working devices and 32 hot spare devices are allowed.
 - It is recommended to use all devices in the same model for compatibility. Contact your dealer for details of models that support the hot spare function.
 - Only certain models support this function.
-

20.1 Set Working Device

Steps

1. Go to **Desktop** → **System Management** → **N+M Hot Spare**.
2. Set **Working Mode** as **Normal Mode**.
3. Turn on **Enable**.
4. Click **Save**.
5. Optional: View **Hot Spare Device IP Address** and **Hot Spare Device Working Status**.

20.2 Set Hot Spare Device

Hot spare device will take over working device tasks when working device fails.

Steps

1. Go to **Desktop** → **System Management** → **N+M Hot Spare**.
2. Set **Working Mode** as **Hot Spare Mode**.
3. Click **Save**. Your device will restart automatically.

Note

- The camera connection will be disabled when the device works in hot spare mode.
-

- It is highly recommended to restore the device defaults after switching the work mode of hot spare devices to normal mode to ensure the normal operation afterwards.
-

4. Go to **Desktop** → **System Management** → **N+M Hot Spare** again.
5. Add working devices to the hot spare system.
6. Add hot spare devices to the hot spare system.
7. Click **Save**.

Chapter 21 Configure Exception Event

Exception events can be configured to take the event hint in the live view interface and trigger alarm output and linkage actions.

Steps

1. Go to **Desktop** → **System Settings** → **Exception**.

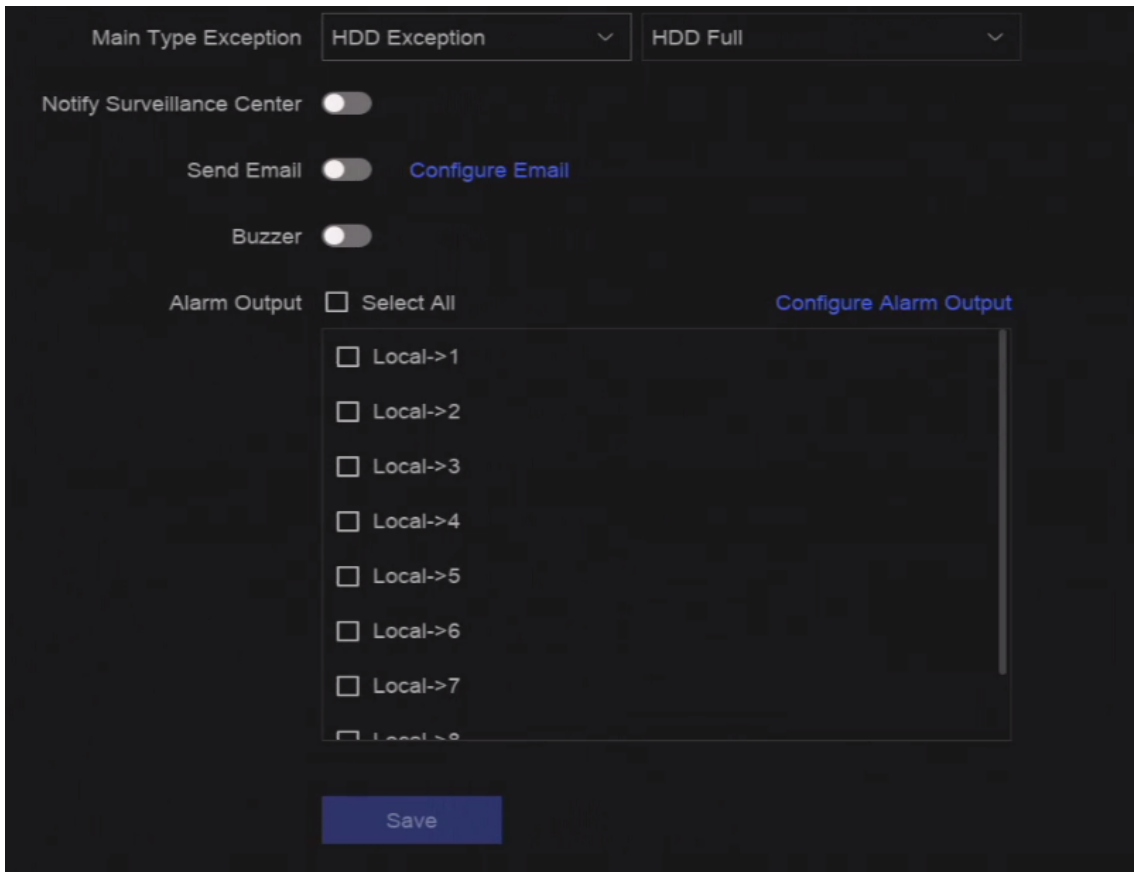

Figure 21-1 Exception Event Configuration



2. Select exception type.
3. Configure the linkage methods.

Table 21-1 Linkage Description

| Linkage Method | Description |
|----------------------------|---|
| Notify Surveillance Center | The device can send an exception or alarm signal to the remote alarm host when an event occurs. The alarm host refers to the PC installed with client software (e.g., NVMS V3, XVMS). |
| Buzzer | When an alarm is detected, the buzzer will make an audible beep. |

| Linkage Method | Description |
|----------------|---|
| Send Email | The system can send an email with alarm information to a user or users when an alarm is detected. |
| Alarm Output | The alarm output can be triggered by alarm input, motion detection, video tampering detection, face detection, line crossing detection, and any all-other events. |

 **Note**

When exception events occur,  at the upper-right corner would notify, and you can click  to view.

4. Click **Save**.

Chapter 22 View System Info

Go to **Desktop** → **System Maintenance** → **Running Info** → **System Info** to view the system information, including video recording information, HDD information, network information, stream information of live view or video playback, time sync diagnosis information, etc. If device exception occurs, for example, when time sync exception occurs and the RTC (coin/button cell) battery is out of power, it may affect the video recording or playback, please resolve the exception as soon as possible.

Chapter 23 System Maintenance

System maintenance functions include log search, schedule reboot, upgrade, etc.

23.1 Schedule Reboot

The device will automatically restart according to the schedule.

Go to **Desktop** → **System Maintenance** → **Maintenance** → **Schedule Reboot** to enable the function and set the reboot schedule.

23.2 Upgrade Device

The device system can be upgraded with a local USB flash drive, remote FTP server, etc.

Go to **Desktop** → **System Maintenance** → **Maintenance** → **Upgrade** to upgrade your device.

23.3 Backup and Restore

Go to **Desktop** → **System Maintenance** → **Maintenance** → **Backup and Restore** to restore or back up system parameters.

Import/Export Configuration File

The device configuration files can be exported to a local device for backup, and the configuration files of one device can be imported to multiple devices if they are configured with the same parameters.

Simple Restore

Restore all parameters, except the network (including IP address, subnet mask, gateway, MTU, NIC working mode, default route, server port, etc.) and user account parameters, to the factory default settings.

Factory Defaults

Restore all parameters to the factory default settings.

Restore to Inactive

Restore the device to the inactive status and leave all settings unchanged except restoring user accounts.

23.4 Log Info

Go to **Desktop** → **System Maintenance** → **Maintenance** → **Log** to search for and export log

information.

Expired Time Settings

When the log disk is full, logs that exceed the period will be overwritten.

23.5 Configure Log Server

You can upload system logs to the server for backup.

Steps

1. Go to **Desktop** → **System Settings** → **Network** → **Network** → **Log Server**.
2. Turn on **Enable**.
3. Set **Upload Time**, **Server IP Address**, and **Port**.
4. Optional: Click **Test** to test if parameters are valid.
5. Click **Save**.

23.6 Maintenance Tools

Multiple tools are provided for system maintenance, such as S. M. A. R. T. detection and bad sector detection.

Before You Start

Ensure HDD is properly installed.

Steps

1. Go to **Desktop** → **System Maintenance** → **Maintenance** → **Maintenance Tools**.
2. Select tools according to your requirements.

Table 23-1 Tool Description

| Tool Name | Description |
|-------------------------|--|
| Network Data Monitoring | Network data monitoring is the process of reviewing, analyzing and managing network data for any abnormality or process that can affect network performance, availability, or security. |
| Network Packet Capture | <p>Ping The ping test is used to detect whether the destination IP address is reachable.</p> <p>NIC Packet Capture After the recorder accessing network, you can use USB flash drive to capture and export network packet.</p> |

| Tool Name | Description |
|----------------------|---|
| HDD Status Detection | You can view the health status of a 4 TB to 8 TB Seagate HDD that generated after October 1, 2017. Use this function to help troubleshoot HDD problems. Health Detection shows a more detailed HDD status than the S.M.A.R.T. function. |
| S.M.A.R.T. Detection | S.M.A.R.T. (Self-Monitoring, Analysis, and Reporting Technology) are HDD monitoring systems to detect various reliability indicators in hopes of anticipating failures. |
| Bad Sector Detection | When an HDD contains too many bad sectors, it is recommended to replace the HDD, otherwise files in the HDD may be lost. |
| HDD Clone | Cope the data in HDD to another one through eSATA interface. |

 **Note**

It is recommended to use maintenance tools with the help of technical support.

23.7 Soft Power Off Configuration

Soft power off function is only available for devices with POWER-AC (AC power exception), POWER-UPS (UPS exception), and POWER-UPSL (UPS low power) alarm outputs (at the real panel). The device can receive and record these alarms. When both POWER-AC and POWER-UPSL alarms are triggered, the device will automatically be powered off according to the present time. When either POWER-AC or POWER-UPSL alarm is not triggered, the device will automatically be powered on.

Steps

1. Go to **Desktop** → **System Maintenance** → **Maintenance** → **Soft Power Off Configuration**.

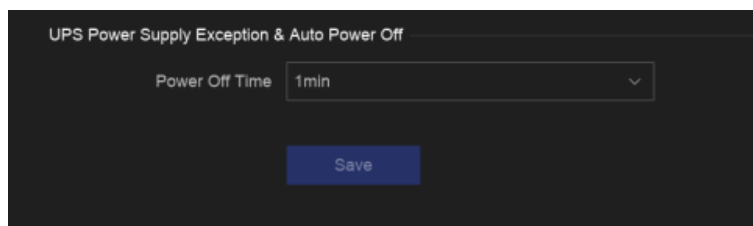

Figure 23-1 Soft Power Off Configuration

2. Set **Power Off Time**. The device would automatically power off after the preset time when corresponding alarms are triggered.
3. Click **Save**.

Example

For example, if **Power Off Time** is set as **1min**, when both POWER-AC (AC power exception) and POWER-UPSL (UPS low power) alarms are triggered, the device would automatically power off after 1 minute.

Chapter 24 Security Management

24.1 Address Filter

The address filter decides whether to allow or forbid specific IP/MAC address to get access to your device.

Before You Start

Log in with the admin account.

Steps

1. Go to **Desktop** → **System Maintenance** → **Security Management** → **Address Filter**.
2. Turn on **Enable**.
3. Set **Filtering Type**. Choose to filter by IP address or MAC Address.
4. Set **Restriction Type**. The device mechanism will allow or forbid specific IP/MAC address to get access to your device.
5. Optional: Set **Restriction List**. You can add, edit or delete address.
6. Click **Save**.

24.2 Stream Encryption

After enabling stream encryption, encryption key would be required for remote live view, remote playback, and the downloaded videos.

Steps

1. Go to **Desktop** → **System Maintenance** → **Security Management** → **Stream Encryption**.
2. Turn on **Enable**.
3. Set **Encryption Key**.

Note

The stream encryption key is synchronized with the LTS Connect service verification code. After enabling the encryption code, the LTS Connect stream will be forcedly encrypted.

4. Click **Save**.

24.3 Select TLS Version

TLS settings will be effective for HTTP(s) and enhanced SDK service. It provides more secure stream transmission service. Go to **Desktop** → **System Maintenance** → **Security Management** →

TLS to select TLS version.

Chapter 25 Appendix

25.1 Glossary

Dual-Stream

Dual-stream is a technology used to record high resolution video locally while transmitting a lower resolution stream over the network. The two streams are generated by the DVR, with the main stream having a maximum resolution of 1080P and the sub-stream having a maximum resolution of CIF.

DVR

Acronym for Digital Video Recorder. A DVR is device that can accept video signals from analog cameras, compress the signal and store it on its hard drives.

HDD

Acronym for Hard Disk Drive. A storage medium which stores digitally encoded data on platters with magnetic surfaces.

DHCP

Dynamic Host Configuration Protocol (DHCP) is a network application protocol used by devices (DHCP clients) to obtain configuration information for operation in an Internet Protocol network.

HTTP

Acronym for Hypertext Transfer Protocol. A protocol to transfer hypertext request and information between servers and browsers over a network.

PPPoE

PPPoE, Point-to-Point Protocol over Ethernet, is a network protocol for encapsulating Point-to-Point Protocol (PPP) frames inside Ethernet frames. It is used mainly with ADSL services where individual users connect to the ADSL transceiver (modem) over Ethernet and in plain Metro Ethernet networks.

DDNS

Dynamic DNS is a method, protocol, or network service that provides the capability for a networked device, such as a router or computer system using the Internet Protocol Suite, to notify a domain name server to change, in real time (ad-hoc) the active DNS configuration of its configured hostnames, addresses or other information stored in DNS.

Hybrid DVR

A hybrid DVR is a combination of a DVR and NVR.

NTP

Acronym for Network Time Protocol. A protocol designed to synchronize the clocks of computers over a network.

NTSC

Acronym for National Television System Committee. NTSC is an analog television standard used in such countries as the United States and Japan. Each frame of an NTSC signal contains 525 scan lines at 60Hz.

NVR

Acronym for Network Video Recorder. An NVR can be a PC-based or embedded system used for centralized management and storage for IP cameras, IP Domes and other DVRs.

PAL

Acronym for Phase Alternating Line. PAL is also another video standard used in broadcast televisions systems in large parts of the world. PAL signal contains 625 scan lines at 50Hz.

PTZ

Acronym for Pan, Tilt, Zoom. PTZ cameras are motor driven systems that allow the camera to pan left and right, tilt up and down and zoom in and out.

USB

Acronym for Universal Serial Bus. USB is a plug-and-play serial bus standard to interface devices to a host computer.

25.2 Frequently Asked Questions

25.2.1 Why is there a part of channels displaying “No Resource” or turning black screen in multi-screen live view?

Reason

1. Sub-stream resolution or bitrate settings are inappropriate.
2. Connecting sub-stream failed.

Solution

1. Go to **Desktop** → **Device Access** → **Device Configuration** → **Device Parameter** → **Video Parameters** → **Sub Stream**. Select the channel and turn down the resolution and max. bitrate (resolution shall be less than 720p, max. bitrate shall be less than 2048 Kbps).

 **Note**

If your video recorder notifies not support this function, you can log in to the camera and adjust video parameters via web browser.

2. Properly set the sub-stream resolution and max. bitrate (resolution shall be less than 720p, max. bitrate shall be less than 2048 Kbps), then delete the channel and add it back again.

25.2.2 Why is the video recorder notifying risky password after a network camera is added?

Reason

The camera password is too weak.

Solution

Change the camera password.

Warning

We highly recommend you create a strong password of your own choosing (Using a minimum of 8 characters, including at least three of the following categories: upper case letters, lower case letters, numbers, and special characters.) to increase the security of your product. And we recommend you reset your password regularly, especially in the high security system, resetting the password monthly or weekly can better protect your product.

25.2.3 Why is the video recorder notifying the stream type not supported?

Reason

The camera encoding format mismatches with the video recorder.

Solution

If the camera is using H.265/MJPEG for encoding, but video recorder does not support H.265/MJPEG, change the camera encoding format to the same as video recorder.

25.2.4 How to confirm the video recorder is using H.265 to record video?

Solution

Check if the encoding type at live view toolbar is H.265.

25.2.5 Why is the video recorder notifying IP conflict?

Reason

The video recorder uses the same IP address as other devices.

Solution

Change the IP address of video recorder. Ensure it is not the same as other devices.

25.2.6 Why is image getting stuck when playing back by single or multi-channel cameras?

Reason

HDD read/write exception.

Solution

Export the video and play it with other devices. If it plays normally on other devices, change your HDD, and try again.

25.2.7 Why is the device not able to control PTZ camera via coaxitron?

Reason

1. The camera does not support coaxitron.
2. The coaxitron protocol is incorrect.
3. The signal is affected by video optical transceiver.

Solution

1. Ensure the video input signal is HDTV, and the camera supports coaxitron.
2. Ensure coaxitron protocol parameters are correct, such as baud rate and address.
3. Remove the video optical transceiver, and try again.

25.2.8 Why does the PTZ seem unresponsive via RS-485?

Reason

1. The RS-485 cable is not properly connected.
2. The RS-485 interface is broken.
3. The control protocol is not correct.

Solution

1. Check if RS-485 cable is properly connected.

2. Change RS-485 interface and try again.
3. Ensure control protocol is Pelco.

25.2.9 Why is the video sound quality not good?

Reason

1. The audio input device does not have a good effect on sound collection.
2. Interference in transmission.
3. The audio parameter is not properly set.

Solution

1. Check if the audio input device is working properly. You can change to another audio input device and try again.
2. Check the audio transmission line. Ensure all lines are well connected or welded, and there is no electromagnetic interference.
3. Adjust the audio volume according to the environment and audio input device.

25.3 Notification for Corrosive Gas

In non-data center room, the corrosive gas concentration limit is recommended to meet the requirements of the chemical active substance 3C2 level in IEC 60721-3-3:2002.

Table 25-1 Corrosive Gas Concentration Limit

| Corrosive Gas Category | Average Value (mg/m ³) | Max. Value (mg/m ³) |
|-------------------------------------|------------------------------------|---------------------------------|
| SO ₂ (Sulfur Dioxide) | 0.3 | 1.0 |
| H ₂ S (Hydrogen Sulfide) | 0.1 | 0.5 |
| Cl ₂ (Chlorine) | 0.1 | 0.3 |
| HCl (Hydrogen Chloride) | 0.1 | 0.5 |
| HF (Hydrogen Fluoride) | 0.01 | 0.03 |
| NH ₃ (Ammonia) | 1.0 | 3.0 |
| O ₃ (Ozone) | 0.05 | 0.1 |
| NO _x (Nitrogen Oxides) | 0.5 | 1.0 |

Note

- The average values in the table above are typical control limits for corrosive gases in the machine room environment. In general, it is not recommended that the concentration of

corrosive gases exceed the average value.

- The maximum value refers to the limit or peak value. The duration for the corrosive gas concentration to reach the maximum value should not exceed 30 minutes per day.

Table 25-2 Common Categories and Sources of Corrosive Gases

| Category | Primary Sources |
|---|--|
| H ₂ S (Hydrogen Sulfide) | Geothermal emissions, microbial activity, oil manufacturing, wood corrosion, wastewater treatment, etc. |
| SO ₂ (Sulfur Dioxide), SO ₃ (Sulfur Trioxide) | Coal combustion, petroleum products, automobile exhaust, smelting ore, sulfuric acid manufacturing, tobacco combustion, etc. |
| S (Sulfur) | Foundry shops, sulfur manufacturing, etc. |
| HF (Hydrogen Fluoride) | Fertilizer manufacturing, aluminum manufacturing, ceramic manufacturing, steel manufacturing, electronic equipment manufacturing, mineral combustion, etc. |
| NO _x (Nitrogen Oxides) | Automobile exhaust, oil combustion, microbial activity, chemical industry, etc. |
| NH ₃ (Ammonia) | Microbial activity, sewage, fertilizer manufacturing, geothermal emissions, etc. |
| CO (Carbon Monoxide) | Combustion, automobile exhaust, microbial activity, tree decay, etc. |
| Cl ₂ (Chlorine), ClO ₂ (Chlorine Dioxide) | Chlorine manufacturing, aluminum manufacturing, zinc manufacturing, waste decomposition, etc. |
| HCl (Hydrogen Chloride) | Automobile exhaust, combustion, forest fires, marine process polymer combustion, etc. |
| HBr (Hydrobromic Acid), HI (Hydroiodic Acid) | Automobile exhaust, etc. |
| O ₃ (Ozone) | Atmospheric optical processes (mostly including nitric oxide and hydrogen peroxide), etc. |
| C _n H _n (Alkane) | Automobile exhaust, tobacco burning, animal waste, sewage, tree decay, etc. |